



buffet | tabletop | bar

# GASTRONOMIE- UND SERVIERARTIKEL

FOOD SERVICE EQUIPMENT  
EQUIPAMIENTOS PROFESIONALES  
EQUIPEMENT PROFESSIONNEL



# 2022

SINCE 1933

# APS – Werkstatt und Bühne für den Genuss

APS – Workshop and stage for enjoyment



family-run company  
since 1933

managing director Reinhold Pott | Bastian Becker



- Eigene Produktion in Deutschland
- own production in Germany
- 25.000 Euro-Palettenlagerplätze
- 25,000 Euro pallet storage spaces



buffet | tabletop | bar

**Assheuer + Pott GmbH & Co. KG**  
Talweg 11 | 59846 Sundern  
Germany  
Phone: +49 (0) 29 33 / 97 35 - 0  
E-Mail: [info@aps-germany.de](mailto:info@aps-germany.de)  
[aps-germany.de](http://aps-germany.de)

GERMAN  
BRAND

in    
Keep in touch! [aps\\_germany](http://aps_germany)



Visit our Website!



























## Ihr Mehrwert: Inspiration & Service

- ✓ aktuellste Nonfood-Trends im Sortiment
- ✓ hohe Warenverfügbarkeit

## Your added value: Inspiration & Service

- ✓ latest nonfood-trends in the range
- ✓ high availability of goods

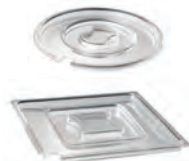

p. 20 	p. 73 	p. 136 
p. 163 	p. 195 	p. 254 
p. 267 	p. 276 	p. 325 
p. 358 	p. 364 	p. 371 
p. 378 	p. 396 	p. 399 
p. 419 	p. 426 	p. 436 
p. 486 	p. 504 	p. 511 
p. 525 	p. 531 	p. 533 

Buffet & Display

Buffet & Tableware  
Melamin

Tableware &  
Table Presentation

Baskets

Chafing Dish,  
GN Container & Transport

Bar, Café & Drinkware

Kitchen & Servings tools

Covers & Accessories

# APS – KNOW-HOW

We only work with the raw material manufacturer who has the best technology in the industry.



## MELAMINE

- ✓ 100% pure melamine
- ✓ BPA free, urea free
- ✓ perfect for serving dishes
- ✓ extremely break and shock resistant
- ✓ sustainable due to durability and robustness
- ✓ hygienic surfaces
- ✓ environmentally friendly due to low processing temperature
- ✓ 100% dishwasher safe
- ✓ useable up to max. 70°C

## STAINLESS STEEL

Chrome-nickel steel is used in a wide variety of products due to its attractive appearance, as a brightly polished, ground or brushed variant.

- ✓ hygienic surface
- ✓ durable and easy to clean
- ✓ recyclable
- ✓ good temperature conductor
- ✓ 100% dishwasher safe

## PLASTIC PP - PS - SAN

- ✓ crystal clear
- ✓ hygienic surface
- ✓ easy to clean
- ✓ recyclable
- ✓ BPA free
- ✓ high resistance to heat
- ✓ durable, no disposable plastic



## WOOD acacia-beech-oak



## PORCELAIN





# Präzisionsarbeit und Design für Ihren Erfolg

Precision work and design for your success



state-of-the-art  
manufacturing  
technology



eco-friendly



high  
professional  
usability

## QUALITÄT

- ✓ Jedes Produkt muss mehr als zwei Qualitätskontrollen bestehen
- ✓ Wir verwenden nur 100% reines Material
- ✓ Jedes Rohmaterial wird streng geprüft

## QUALITY

- ✓ each product must pass more than two quality checks
- ✓ we only use 100% pure material
- ✓ each raw material is strictly tested

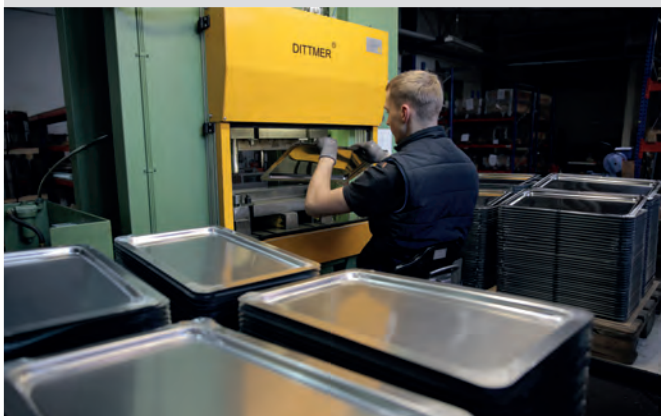

APS production | Made in Germany (tray no. 11100)

## DESIGN

- ✓ Unsere eigenständig entwickelten Produkte verfügen über zahlreiche Design-Patente im In- und Ausland
- ✓ Wir entwickeln Produktlösungen für jeden individuellen Kundenbedarf

## DESIGN

- ✓ our independently developed products have rich / multi design patents at home and abroad
- ✓ we develop product solutions for every individual customer need



Design team

**DEUTSCH****Artikel Seite****A**

Abräumwagen	408-409
Abtropfmatte	451
Adapter / Zwischensteg	401
Allzweckgießer	302, 458
Antirutschmatte	170
Aschenbecher	471-475
Aufstrichmesser	501
Ausgießer	455
Ausstellblech	509
Austernmesser	498

**B**

Backblech	404
Backform	509
Backhandschuhe	510
Baguette Korb	357, 364
Bain-Marie	392
Bar-Caddy	452
Barlöffel	442
Barmaß	439-441
Barmatte	451
Barsieb	443, 445
Becher	268, 426-434
Becher Emaille	320
Behälter	409
Bento Box	174
Beschriftungsetiketten	74, 348
Beschriftungskarten	342
Besteckablage	256, 395
Besteckbehälter	21, 105, 150-154, 187, 335-339, 410-411
Besteckkorb	334, 364-365
Besteckständer	105-106, 152-154, 334-337, 339
Besteckständer Melamin	105
Bestecktaschen	318
Beton	40, 76, 157, 193-194, 294, 307, 312-313, 341, 424, 474
Bierglasträger	425
Blattschale Melamin	201, 217, 244
Bonleiste	514
Bonspieß	514
Brennpastenbehälter Edelstahl	394
Brezel- oder Wurstständer	86, 141
Brötchenschütte	210, 251, 355
Brötchenspender Edelstahl	102
Brotkorb	355, 365-366, 369
Brottschneidebrett	23, 94-95, 142
Brotstation	94
Brottasche	367-369, 373
Buffet Kühlset	14, 18, 27, 30-33, 35-38
Buffet Kühlset Edelstahl	28-29, 33-34
Buffet-Set	35, 113, 121
Buffetbrett	132, 140, 141
Buffetbrücke	72
Buffetgestell	72-74, 79-82, 85-92, 100, 102, 106, 326, 364
Buffetkorb	16, 176, 356, 358, 361-363
Buffetleiter	79-80, 83
Buffetschilder	341, 345, 347
Buffetständer	66, 71-73, 76-77, 79-83, 85, 89-91, 100, 106-109, 115, 176, 205, 253, 374-375
Buffetständer Edelstahl	176
Buffetständer Holz	71-73, 76-77, 86-88, 109
Buffetständer Metall	73, 79-83, 85, 89-90, 109, 115, 206
Buffetvitrine	26-29, 36-37, 97
Buffetvitrine Edelstahl	28-29
Bürste Bar	449
Butter- und Saucenwärmer	305
Butterdose	304

Butterservierer	304
-----------------	-----

**C**

Caddy	93, 136, 153-154, 306-309, 334, 452
Cerealenspender	21, 64-67
Cerealenspender Edelstahl	65-66
Chafing Dish	378-379, 381-386, 388-390
Chafing Dish Rolltop	385-386, 389
Champagnerkühler	420-421
Cocktailmesser	445, 497

**D**

Dariorform	509
Deckel	19, 34, 160-161, 171, 237, 241-242, 249, 532-534
Deckel Edelstahl	325, 400-401
Dekoriermesser	445, 498
Desinfektionsspender	98
Desinfektionsständer	98
Dip-Schälchen	223, 248, 250
Dispenser Milch	20, 39-46, 49-52
Dispenser Saft	20, 39-46, 49-51, 53
Dispenser Saft / Milch	20, 39-46, 49
Dosier- & Vorratsflasche	454
Dosierer Zucker	301-303, 458-460
Dosierpumpe	518
Dosierspender	518
Dressingtopf Edelstahl	74
Dressingtopf Melamin	74-75
Dressingtopf Porzellan	75

**E**

Eier-Box	511
Eierbecher	256, 304
Eierkorb	363
Eierschneider	502
Eimer	413, 511
Eis-Kugel-Former	448
Eisbox	16, 447
Eiseimer	416, 446
Eisportionierer	492, 515
Eisschaufel	448
Eiswaffel-Ständer	515
Eiswasseröhre	40
Eiswürfelform	456
Eiszange	449
Eiszerkleinerer	448
Emaille-Artikel	319-320
Entkerner	497
Etagère	73, 87-89, 91-92, 131, 233

**F**

Fadenschneider	496
Fast-Food Tablett	145, 469
Feuerzangenbowle-Set	305, 349, 391, 435-436
Fingerfood-Löffel	257-258
Flambierbrenner	463, 502
Flasche	58, 60, 536
Flaschenhalter Wein	425
Flaschenkühler	21, 62, 416-417, 419-425, 429, 453
Flaschenöffner	62, 457
Flaschenträger	425
Fleisch- / Gemüseplatte	110
Folien-Abreibvorrichtung	514
Fondue-Set	305, 349, 391, 436
Frischhaltedeckel	19, 34, 327

**G**

Gabel Fleisch	480-481, 485
Gabel Salat	484
Gebäckpalette	499
Gebäckzange	486, 490-492
Gemüsehobel	506
Getränkenspender	39-47, 452
Getränkewanne	61, 419, 420
Gewürzkasten	518
Gewürzmühle	285-290
Gewürzständer	293-300

Gewürzstreuer	291-292
Gläsernschiene	418, 433
Glasplatte	121
Glasmrander	448
Glocke	332
GN Abtropfgitter	401-402
GN Behälter	24, 111, 396, 398-399, 402-403, 405-407
GN Behälter Edelstahl	111, 398-399
GN Besteckbehälter	151, 359, 404, 410
GN Buffet-Set	113, 405, 407
GN Buffetgestell	364
GN Buffetleiter	83-84
GN Buffetständer	206
GN Buffetvitrine Edelstahl	28
GN Chafing Dish	378, 381-382, 385-386, 389-390

GN Deckel	400-403, 406
GN Haube	113, 191, 363, 524-526
GN Konvektomatenblech	404
GN Korb	16, 352, 354, 359-361, 363
GN Korb Metall	371-372
GN Korb Polypropylen	352, 354, 359-361
GN Naturschieferplatte	24-25, 128-129
GN Partyplatte	123
GN Rost	404
GN Schale Melamin	163, 166, 168, 209
GN Servierbrett	132
GN Serviergestell	17, 85
GN Tablett	15, 25, 71, 110-113, 127, 144-145, 234, 405
GN Tablett Edelstahl	110-113, 234
GN Tablett Melamin	25, 71, 163-166, 170, 178, 180, 183-184, 186, 188, 191, 194-195, 197-198, 206, 211-212, 215, 220, 227, 231, 237-239, 243
GN Tablett Porzellan	127, 405
GN Wanne	15, 24
Gourmetgläser	322
Gourmetlöffel	268

**H**

Haube	16-17, 103, 117-119, 121, 149, 204, 253, 527-531
Haube Rolltop	16-17, 117, 120, 253, 392, 526-527
Haube Rolltop Edelstahl	392
Haubenhalterung	103
Heizelement	53, 385-386, 392-394
Hobel	141, 498, 506
Holzbox	22-25, 94, 136, 139, 153-154, 283, 306-309, 334
Honiglöffel	495
Humberbrecher	502
Hygieneschutz	96, 99, 102

**I**

Induktionskochplatte	78, 379-380, 387, 393
Iso-Dispenser	46
Isolierkanne	54-55

**K**

Kaffeebecher	256
Kaffeedispenser Edelstahl	53, 392
Kaffeekanne	461
Kanne	59-60
Kanne Saft	59-60
Karaffe Glas	56-57, 59
Kartenhalter	340-346
Käseglocken-Set	120
Käsehobel	498
Kaviarkühler	118, 305
Kellnermesser	457
Kerzenleuchter	310-312
Konditorplatte	146-147, 185, 213, 252, 329
Konferenzkühler	21, 62, 453
Korb Edelstahl	373

Korb Metall	369, 371-375
Korb Polypropylen	353, 356-358, 361-363, 366
Korkenzieher	457
Kreide-Marker	348
Kronkorkenschale	62
Kugelausstecher	496
Kühlakku	19, 62, 535
Kühlbox	18, 30, 31, 61, 447
Kühlkaraffe	58
Kühlmanschette	425
Kühlschale	19, 32-34
Kühltablett	14, 27, 29

**L**

Likör- und Fondanttrichter	506
Limettenpresse	446, 513
Löffel	479-480, 485, 492-495
Löffel Backen	492
Löffel Feinkost	268, 493, 495
Löffel Fingerfood	228
Löffel Frittieren	505
Löffel Gourmet	268
Löffel Salat	255, 483, 484
Löffel Saucen/Dressing	480, 483, 485, 493
Löffel Spaghetti	480, 482
Lunchbag	373
Lunchbox	537

**M**

Magnet-Messerhalter	514
Mandoline	506
Menage	242, 293-300
Messbecher	507-508
Messlöffelsatz	492
Metallrahmen für Induktionskochplatte	382-384, 393
Milchdispenser	20, 39-46, 49-52
Milchgießer/-kännchen	460-461
Milchkanne	51-52, 460-461
Minis	248, 259-262
Moscow Mule Becher	429-431
Mühle Pfeffer	285-290
Mühle Salz	285-290
Multi Rack Edelstahl	104-105
Multibox	93
Muscheltopf	327
Müslispender	21, 64-67

**N**

Naturschieferplatte	24-25, 128-131, 277-278, 290
---------------------	------------------------------

**P**

Palmbattschale Melamin	244-245
Panierstation	513
Parmesan Menage	298
Partyplatte	123
Passiersieb	503-504
Pastateller Melamin	243
Pendelschäler	497
Permanent-Ausgießer	455
Pfanne	115, 270, 272
Pfannenwender	478, 483-484
Pfeffermühle	285-290
Pinsel	513
Pinzettzange	449, 489
Pitcher	60
Pizzaform	519, 521
Pizzaschaufel	502, 510
Pizzaschneider	497, 502, 521
Platzsets	314-317
Platzteller	332
Pommes-Frites-Seiher	505
Porzellan	379, 384
Pump-Isolierkanne	54

**Q**

Quetschflasche	515-517
----------------	---------

**R**

Rechnungstablett	333, 470
------------------	----------



Regalwagen	409
Reinigungsbürste	449
Rezeptionsglocke	466
Rolltop-Set	120-121, 130
Rührbecher	508
Rührglas	454
<b>S</b>	
Saftdispenser	39-45, 49-51, 53
Saftkanne	59-60
Salat-Löffel	255
Salatbesteck	494
Salatzange	479, 486-487, 490
Salzmühle	285-290
Sauciere	331
Schälchenspender	81
Schale Aluminium	274, 370
Schale Beton	76
Schale Edelstahl	19, 114, 266-267, 273, 373-374
Schale Emaille	304, 319-320
Schale Glas	79-81, 534
Schale Holz	138-139, 275-276
Schale Melamin	19, 34, 81, 160, 162-163, 165, 167-169, 171, 177, 179, 181-182, 185, 187-188, 190, 192-194, 197, 199, 201, 204, 207-210, 213, 217-219, 221-227, 229-237, 240-248, 250, 253, 255, 259-262, 346
Schaufel	495, 511
Schaufel Eis	448
Schaufel Mehl	510
Schaumlöffel	479, 482
Schaumspesering	507
Schiefer	24-25, 86, 91, 121, 128-131, 133-134, 146, 212, 214, 251, 277-279, 281, 290, 468
Schilder	342-343, 345
Schlüsselschnur	453
Schneebesens	503
Schneidbrettständer	515
Schneidbrett	15, 23, 94-95, 100, 445
Schöpflöffel	479-480, 482
Sektkühler	61, 416-417, 419, 421-422
Senftöpfchen	295
Service Tower	106
Servier-/Tortenplatte Edelstahl	329-330
Servier-/Tortenplatte Holz	135, 147-148, 328, 330
Servier-/Tortenplatte Melamin	146, 252, 329-330
Servier-Frittierkorb	271
Servierbox	254, 269, 283-284
Servierbrett	132-137, 139-141, 276, 279-281, 468
Serviergabel	480-481, 485
Serviergestell	82, 85, 89-92, 326
Servierkelle	269, 464
Servierkorb	274, 358, 370
Servierlöffel	255, 479-485
Servierpfanne	115, 270, 272
Servierpfanne Gusseisen	270
Servierset	160-161, 209
Serviertablett	119, 124-125, 143-144, 464-470
Serviertöpfchen	118, 268, 272-273
Servierwagen	408-409
Servierzange	486
Serviettenhalter	155-157
Serviettenringe	333
Serviettentaschen	318
Shaker	437-438
Sieb	443, 445, 503-504
Snackbox	254, 269, 283-284, 537
Snackholder	271-276
Snackpresenter	101
Sortierbox	93
Spachtel	501

Spaghettizange	479, 486, 488
Spargelzange	486
Sparschäler	496
Speisenwärmer	394
Spießständer / Spieße	305
Spitzsieb	505-506
Spritzflasche	300, 454
Standascher	475
Ständer Wein- / Sektkühler	418
Staubkappen	453
Stielkasserolle	268
Stößel	444
Stövchen	63
Streichpalette	499
Streuer Pfeffer	291-292
Streuer Salz	291-292, 505
Superbox	22-25
Suppenkelle	483
Suppentopf	383, 389-390
Sushiboard Melamin	184, 225-226
<b>T</b>	
Table Caddy	153-154, 306-309, 334
Tablett	15, 94, 112-119, 124, 126, 143, 145, 267, 280, 282, 355, 468-469
Tablett Edelstahl	15, 112-119, 124, 126, 267, 282, 464-466
Tablett Fast Food	136, 145, 469
Tablett Holz	103, 121-122, 145, 280, 468-469
Tablett Melamin	25, 71, 163-164, 166, 170, 178-180, 183-186, 188, 191, 193-199, 205-208, 211-217, 219-221, 225-228, 231, 235, 237-239, 253, 262, 290
Tasse Melamin	256
Teebox	93
Teebrühsieb	463
Teekanne ASIA	63, 461
Teigbehälter	412, 521
Teigschaber / Abstecher	501
Teller Emaille	319
Teller Fingerfood	234
Teller Melamin	144, 162, 164, 172, 177, 179, 181-182, 184, 186, 189, 196, 200, 218, 221, 240, 246-247, 253-256, 261
Thekendisplay	97, 101
Thermo Tablett-Set	36-38
Thermo-Set	31
Tischaufsteller	347
Tischkartenhalter	342-346
Tischkrümelentferner	332, 470
Tischrestebehälter	335-336, 338
Tischsets	314-318
Tortenheber	483, 485
Tortennmesser	483
Tortenplatte	120, 130, 146-148, 185, 213, 252
Tortenring	509
Transportwagen	408-409
Trenner	356
Tretbeutelhälter	475
Trichter	413, 512
Trinkbecher	42-45, 268, 426-428
Trinkflasche	536
Trinkglas	41
Trinkhalme	450
Tropfenschale Melamin	40
<b>U</b>	
Universalbox	17, 70
Universalkanne	460-461, 507
Untersetzer Edelstahl	333
Untersetzer Kork	42-44, 520
Untersetzer Naturschiefer	130-131, 277, 290
<b>V</b>	
Vase	313
Verschluss Wein / Champagner	455

Vorratsglas	68-70
Vorspeisenzange	488
<b>W</b>	
Wachspapier	132, 136, 282, 284
Wanne	412
Warenträger	123, 314
Wärme-Kies	395
Warnschild	521, 535
Wasserbadschüssel	506
Wasserkanne	59
Wasserspender	39-47, 452
Weck Gläser	70, 82, 321-326
Weinkühler	61, 416-417, 419, 421-422
Weinkühlerständer	418
Wender	478, 482-484, 499-500
Windaschenbecher	471-474
Windlicht	312
<b>Z</b>	
Zange	449, 479, 486-488, 490-491
Ziseliermesser	496
Zitronenschnitzelpresse	463
Zitruspresse	445-446, 513
Zuckerdosierer	301-303, 458-460
Zuckerkugel	303, 463
Zuckerspender	301-303, 458-460
Zuckertüten-Box Edelstahl	462
Zutatenbehälter	452
 <b>ENGLISH</b>	
<b>item</b>	<b>page</b>
<b>A</b>	
adapter	401
air pot	54
airtight cover	19, 34, 327
appetizer tong	488
ashtray	471-475
asparagus tongs	486
<b>B</b>	
baguette basket	357, 364
bain marie bailing bowl	506
Bain-Marie	392
baking mittens	510
baking pan	509
baking sheet	404
bar caddy	452
bar knife	445, 497
bar spoon	442
bar strainer	443, 445
barrel mug	268, 426-434
basket metal	369, 371-375
basket PP	353, 356-358, 361-363, 366
basket stainless steel	373
beaker	320
beer rack	425
Bento Box	174
beverage dispenser	39-47, 452
beverage tub	61, 419-420
bill presenter	333, 470
bill rail	514
bill spike	514
bottle	58, 60, 536
bottle cooler	21, 62, 416-417, 419-425, 429, 453
bottle fuel	394
bottle opener	62, 457
bottle rack	425
bowl aluminium	274, 370
bowl concrete	76
bowl enamel	304, 319-320
bowl glass	79-81, 534
bowl holder	81
bowl melamine	19, 34, 81, 160, 162-163, 165, 167-169, 171, 177, 179, 181-182, 185, 187-188, 190, 192-194, 197, 199, 201, 204, 207-210, 213, 217-219, 221-227, 229-237, 240-248, 250, 253, 255, 259-262

bowl stainless steel	19, 114, 266-267, 273, 373-374
bowl wood	138-139, 275-276
bread basket	367-369, 373
bread station	94
Breadbox	355, 365-366, 369
breeding set	513
brush	513
bucket	413, 511
buffet basket	16, 176, 356, 358, 361-363
buffet bridge	72
buffet ladder	79, 80, 83
buffet set	35, 113, 121
buffet signs	341, 345, 347
buffet stand	66, 71-74, 76-77, 79-83, 85-92, 100, 102, 106-109, 115, 176, 205, 253, 326, 364, 374-375
buffet stand metal	73, 79-83, 85, 89-90, 109, 115, 206
buffet stand stainless steel	176
buffet stand wood	71-73, 76-77, 86-88, 109
Buffet-board	132, 140-141
butter and sauce pan warmer	305
butter dish	304
<b>C</b>	
caddy	93, 136, 153-154, 306-309, 334, 452
cake lifter	483, 485
cake plate melamine	146, 252, 329-330
cake plate stainless steel	329-330
cake plate wood	135, 147-148, 328, 330
cake setting ring	509
cake slice	483
cake stand	120, 130, 146-148, 185, 213, 252, 329
candle holder	310-312
canele / decorating knife	496
canister	68-70
cap bowl	62
cast iron pan	270
caviar cooler	118, 305
cereal dispenser	21, 64-67
cereal dispenser stainless steel	65-66
Chafing Dish	378-379, 381-382, 384-386, 388-390
Chafing Dish Rolltop	385-386, 389
chalk marker	348
champagne bowl	61, 416-417, 419-422
champagne / wine saver	455
cheese dish	298
cheese slicer	498
chefs blow torch	463, 502
chopping board	15, 23, 94-95, 100, 445
citrus squeezer	445-446, 513
cleaning brush	449
clingfilm tear-off dispenser	514
cloche / dome cover	332
coaster cork	42-44, 520
coaster natural slate	130-131, 277, 290
coaster stainless steel	333
coffee cup	256
coffee dispenser stainless steel	53, 392
coffee pot	461
concrete	40, 76, 157, 193-194, 294, 307, 312-313, 341, 424, 474
condiment container	518
condiment holder	452
confectionery funnel	506
conference bottle cooler	21, 62, 453
conical strainer	505-506
cool collar	425
cooler	19, 62, 535
cooling bowl	19, 32-34
cooling box	18, 30-31, 61, 447
cooling box stainless steel	28-29, 33-34

cooling carafe	58	GN buffet display stainless steel	28	mixing glass	454	servicing trowel	269, 464
cooling plates	14, 27, 29	GN buffet ladder	83, 84	Moscow Mule barrel mug	429-431	set measuring spoon	492
corer	497	GN buffet set	113, 405, 407	mousse ring	507	shaker	291-292, 437-438
corkscrew	457	GN buffet stand	206, 364	muddler	444	shape sorter	93
cornet stand	515	GN Chafing Dish	378, 381-382, 385-386, 389-390	multi rack stainless steel	104-105	showcase	26-29, 36-37, 97, 101
cover	16-17, 19, 34, 103, 117-119, 121, 149, 160-161, 171, 204, 237, 241-242, 249, 253, 527-534	GN cover	113, 191, 363, 524-526	multibox	93	showcase stainless steel	28-29
cover holder	103	GN cutlery organizer	151, 359, 404, 410	mussel pot	327	skewer rack/skewer	305
cover stainless steel	325, 400-401	GN grid	404	mustard glass	295	skimmer spoon	479, 482, 492
crumber	332, 470	GN natural slate tray	24-25, 128-129	<b>N</b>		slate	24-25, 86, 91, 121, 128-131, 133-134, 146, 212, 214, 251, 277-279, 281, 290, 468
cup melamine	256	GN pan stainless steel	111, 398-399	napkin bag	318	small serving pot	118, 268, 272-273
curler	141, 498, 506	GN partytray	123	napkin holder	155-157	snack tray	136, 145, 469
cutlery bag	318	GN serving board	132	napkin rings	333	snackbox	254, 269, 283-284, 537
cutlery basket	105-106, 152-154, 334-337, 339	GN serving stand	17, 85	natural slate tray	24-25, 128-131, 277-278, 290	snackpresenter	101
cutlery basket melamine	105	GN tray	15, 24-25, 71, 110-113, 127, 144-145, 234, 405	non slip mat	170	oyster knife	463
cutlery dispenser	334, 364-365	GN tray melamine	25, 71, 163-164, 166, 170, 178, 180, 183-184, 186, 188, 191, 194-195, 197-198, 206, 211-212, 215, 220, 227, 231, 237-239, 243	oyster knife	498	soup ladle	483
cutlery organizer	21, 105, 150-154, 187, 335-337, 339, 410-411	GN tray porcelain	127, 405	<b>P</b>		soup pot	383, 389-390
cutlery rest	256, 395	GN tray stainless steel	110-113, 234	palm leaf melamine	244-245	soup pot	383, 389-390
cutting board	23, 94-95, 142	GN-container	24, 111, 396, 398-399, 402-403, 405-407	pan	115, 270, 272	spaghetti spoon	480, 482
cutting board rack	515	GN-convection oven trays	404	party spoon	228, 257-258, 268	spaghetti tong	479, 486, 488
<b>D</b>		GN-drainer	401-402	partytray	123	spatula	499
Dariol moulds	509	GN-lid	400-403, 406	pasta plate melamine	243	spice mill	285-290
decorating knife	445, 498	gourmet glasses	322	pastry spatula	499	spice rack	293-300
decorator / zester	496	graduated jug	507-508	pastry tongs	486, 490-492	spice shaker	291-292
delicatessen spoon	268, 493, 495	granite chips	395	pedal bin	475	spider spoon	505
designation cards	342	gravy boat	331	peeler	496	spoon	479-480, 485, 493-495
desinfectant dispenser	98	greaseproof paper squares	132, 136, 282, 284	pepper mill	285-292	squeeze bottle	300, 454, 515-517
desinfection stand	98	<b>H</b>		pitcher	59-60	stainless steel frame for induction plate	382-384, 393
dip bowl	223, 248, 250	heating unit	53, 385-386, 392-394	pizza cutter	497, 502, 521	stand for wine / champagne bowl	418
dispenser	518	honey spoon	495	pizza dish	519, 521	standing ashtray	475
dispenser sugar	301-303, 458-460	hygienic cover	96, 99, 102	pizza peel	502, 510	stirring cup	508
display	123, 314	<b>I</b>		placemat	314-318	strainer	443, 445, 503-504
display tray	509	ice ball former	448	plate enamel	319	straws	450
divider	356	ice box	16, 447	plate melamine	144, 162, 164, 172, 177, 179, 181-186, 189, 196, 200, 218, 221, 240, 246-247, 253, 255-256, 261	sugar dispenser	301-303, 458-460
dosing pump	518	ice bucket	416, 446	plate tray	332	sugar pocket holder	462
dough container	412, 521	ice cream scoop	492, 515	plate warmer	394	sugar pot	303, 463
dough scraper	501	ice crusher	448	porcelain	379, 384	superbox	22-25
dressing pot melamine	74-75	ice cube cooling tube	40	pourers	302, 455, 458	sushiboard melamine	184, 225-226
dressing pot porcelain	75	ice cube maker	456	pouring container	454	swivel peeler	497
dressing pot stainless steel	74	ice scoop	448	pretzel-/ sausage stand	86, 141	<b>T</b>	
dressing/sauce spoon	480, 483, 485, 493	ice tong	449	<b>R</b>		table caddy	153-154, 306-309, 334
drinking bottle	536	induction plate	78, 379-380, 387, 393	refrigerated buffet display	14, 18, 27, 30-33, 35-38	table garbage bin	335-336, 338
drinking cups	41-45, 268, 426-428	insulated dispenser	46	ring bell	466	table stands	340-347
drip mat	451	<b>J</b>		roll / bun basket	210, 251, 355	tea-box	93
drip tray melamine	40	jigger	439-441	roll dispenser stainless	102	teapot ASIA	63, 461
dust & fly cap	453	jug	461, 507	rolltop cover	16, 17, 117, 120, 253, 392, 526-527	teapot warmer	63
<b>E</b>		juice and milk dispenser	20, 39-46, 49	rolltop set	120-121, 130	thermo set	31
egg basket	363	juice dispenser	20, 39-46, 49-51, 53	rolltop set cheese	120	thermo tray	36-38
egg cutter	502	juice pitcher	59-60	rolltop-cover stainless steel	392	tong	449, 479, 486-488, 490-491
egg holder	256, 304	<b>K</b>		<b>S</b>		tray	15, 73, 87-89, 91-92, 94, 110, 112-119, 124-125, 131, 143-146, 233, 267, 280, 282, 355, 464-470
eggs box	511	key cord	453	salad fork	484	tray melamine	25, 71, 163-164, 166, 170, 178-180, 183-186, 188, 191, 193-199, 205-208, 211-217, 219-221, 225-228, 231, 235, 237-239, 253, 262, 290
enamel articles	319-320	<b>L</b>		salad spoon	255, 483-484	tray stainless steel	15, 112-119, 124, 126, 267, 282, 464-466
<b>F</b>		labeling labels	74, 348	salad spoon + fork	494	tray wood	103, 121-122, 145, 280, 468-469
fingerfood plate	234	labels	342-343, 345	salad tong	479, 486-487, 490	trolley	409
fire punch bowl set	305, 349, 391, 435-436	ladle	479-480, 482	salt mill	285-292, 505	turner	478, 482-484, 499-500
flower vase	313	leaf melamine	201, 217, 244	sandwich knife	501	tweezer	449, 489
fondue set	305, 349, 391, 436	lemon slice squeezer	463	sauté pan / mini sauce pan	268	<b>U</b>	
fork	480-481, 485	lime press	446, 513	scoop	495, 511	universal box	17, 70
free flow pourer	455	lobster cracker	502	scoop flour	510	<b>V</b>	
fry baskets	271	lunch bag	373	scraper	501	vacuum jug	54-55
fry dripping tray	505	lunchbox	537	service tower	106	<b>W</b>	
funnel	413, 512	<b>M</b>		service trolley	408-409	waiter's corkscrew	457
<b>G</b>		magnetic knife rack	514	servicing basket	274, 358, 370	warning sign	521, 535
glass carafe	56-57, 59	mandolin	506	servicing board	132-137, 139-141, 276, 279-281, 468	water pitcher	59
glass plate	121	meatfork	480-481, 485	servicing box	254, 269, 283-284	Weck-bottles	70, 82, 321-326
glass rack	418, 433	melon baller	496	servicing cup	271-276	whisk	503
glass rimmer	448	menage	242, 293-300	servicing set	160-161, 209	wind lights / candle holder	312
GN basket	16, 352, 354, 359-361, 363	milk dispenser	20, 39-46, 49-52, 460-461	servicing spoon	255, 479-485		
GN basket metal	371-372	milk jug	460-461	servicing stand	82, 85, 89-92, 326		
GN basket polypropylene	352, 354, 359-361	mini bowl	248, 259-262	servicing tongs	486		
GN bowl melamine	163, 166, 168, 209			servicing trolley	408-409		



wine bowl 61, 416-417, 419, 421-422  
 winebottle-stand 425  
 woodbox 22-25, 94, 136, 139, 153-154,  
 283, 306-309, 334

## ESPAÑOL

### artículos pág.

**A**  
 abre ostras 498  
 abridor 62, 457  
 acumulador de frío 19, 62, 535  
 adaptador 401  
 aro anti-goteo melamina 40  
 aro de tarta 509  
 aro redondo para semifríos 507  
 artículos esmaltados 319-320  
 azucarero 301-303, 458-460

**B**  
 bajo plato 332  
 bandeja 15, 94, 112-119, 124-126,  
 143-144, 267, 280, 282, 355, 464-470  
 bandeja acero inoxidable 15, 112-119,  
 124, 126, 267, 282, 464-466  
 bandeja autoservicio y snacks 136, 145,  
 469  
 bandeja con alturas 73, 87-89, 91-92,  
 131, 233  
 bandeja de pizarra natural 24-25,  
 128-131, 277-278, 290  
 bandeja de vidrio 121  
 bandeja isotérmica 31  
 bandeja madera 103, 121-122, 145,  
 280, 468-469  
 bandeja melamina 25, 71, 163, 164,  
 166, 170, 178-180, 183-186, 188, 191,  
 193-199, 205-208, 211-217, 219-221,  
 225-228, 231, 235, 237-239, 253, 262,  
 290  
 bandeja para sushi melamina 184,  
 225-226  
 bandeja party 123  
 bandeja pastelera 404, 509  
 bandeja tartas acero inoxidable 329-330  
 bandeja tartas madera 135, 147-148,  
 328, 330  
 bandeja tartas melamina 146, 252,  
 329-330  
 bandeja termo 36-38  
 bandejas refrigeradas 14, 27  
 baño María 392  
 barra magnética para cuchillos 514  
 barroño botellines 61, 419-420  
 batidor 503  
 Bento Box 174  
 bol refrigerado 19, 32-34  
 bolsa cubiertos 318  
 bolsa de almuerzo 373  
 bolsa de servilletas 318  
 bomba dosificadora 518  
 bote 68-70  
 bote de mostaza 295  
 bote dosificador flexible 515-517  
 bote vertedor universal 302, 458  
 botella 58, 60, 536  
 botella „store & pour“ 454  
 botella de combustible líquido 394  
 botella exprimible 300, 454  
 botes especieros 291-292  
 brocha 513

**C**  
 calletes buffet 341, 345, 347  
 calletes de mesa 347  
 cacerola 115, 270, 272  
 caddy 93, 136, 153-154, 306-309, 334  
 caddy de mesa 153-154, 306-309, 334  
 cafetera 461

caja comida 254, 269, 283-284  
 caja de pan para buffet 355, 365-366, 369  
 caja dispensadora 17, 70  
 caja madera 22-25, 94, 136, 139,  
 153-154, 283, 306-309, 334  
 caja para huevos 511  
 caja para sobres de azúcar 462  
 caja para té 93  
 caja surtida 93  
 calentador de mantequilla y salsa 305  
 calentador de tetera 63  
 calienta platos 394  
 campana 16-17, 103, 117-119, 121,  
 149, 204, 253, 527-531  
 campana esférica 332  
 campana rolltop 16-17, 117, 120, 253,  
 392, 526-527  
 campana rolltop acero inoxidable 392  
 candelabro 310-312  
 cantimplora 536  
 carro 409  
 carro de servicio 408-409  
 cazo para baño maría 506  
 cazo recto bajo 268  
 cenicero 471-475  
 cenicero de pie 475  
 cepillo de limpieza 449  
 cesta acero inoxidable 373  
 cesta de baguette 357, 364  
 cesta de buffet 16, 176, 356, 358,  
 361-363  
 cesta de huevos 363  
 cesta metal 369, 371-375  
 cesta para bollos 210, 251, 355  
 cesta para servir 274, 358, 370  
 cesta polipropileno 353, 356-358,  
 361-363, 366  
 cestitas para el servicio mesa 271  
 Chafing Dish 378-379, 381, 382,  
 384-386, 388-390  
 Chafing Dish Rolltop 385-386, 389  
 champañera 420-421  
 coctelera 437-438  
 colador 443, 445, 503-504  
 colador cónico 505-506  
 colador de cóctel 443, 445  
 conjunto aperitivo 242, 293-300  
 corta huevos 502  
 corta pasta 501  
 cortador de pizza 497, 502, 521  
 cubeta 412  
 cubierta higiénica antialiento 96, 99, 102  
 cubitera 16, 447  
 cubitera isotérmica 416, 446  
 cubitera para cava 61, 416-417, 419,  
 421-422  
 cubo 413, 511  
 cuchara 479-480, 485, 493-495  
 cuchara de espaguetis 480, 482  
 cuchara de miel 495  
 cuchara gourmet 268, 493, 495  
 cuchara para ensalada 255, 483, 484  
 cuchara para helado 492, 515  
 cuchara para hornear 492  
 cuchara para servir 255, 479-485  
 cuchara party 257, 258  
 cucharilla de cóctel 442  
 cucharón 479, 480, 482  
 cucharón de salsa/aliño 480, 483, 485, 493  
 cucharón de sopa 483  
 cuchillo acanalador 445, 498  
 cuchillo de decoración cincelador 496  
 cuchillo para cóctel 445, 497  
 cuchillo para untar 501  
 cuenco acero inoxidable 19, 114,  
 266-267, 273, 373-374

cuenco aluminio 274, 370  
 cuenco de vidrio 79-81, 534  
 cuenco esmaltado 304, 319-320  
 cuenco hormigón 76  
 cuenco madera 138-139, 275-276  
 cuenco melamina 19, 34, 81, 160, 162-163,  
 165, 167-169, 171, 177, 179, 181-182,  
 185, 187-188, 190, 192-194, 197, 199,  
 201, 204, 207-210, 213, 217-219, 221-227,  
 229-237, 240-248, 250, 253, 255, 259-262  
 cuenco mini 248, 259-262  
 cuenco para chapas 62  
 cuenco para dip 223, 248, 250

**D**  
 descorazonador 497  
 dispensador buffet en escalera 79-80, 83  
 dispensador de bebidas 39-47, 452  
 dispensador de bocadillos 101  
 dispensador de café acero inoxidable  
 53, 392  
 dispensador de cereales 21, 64-67  
 dispensador de cereales acero inoxidable  
 65-66  
 dispensador de desinfectante 98  
 dispensador de film 514  
 dispensador de leche 20, 39-46, 49-52,  
 460-461  
 dispensador de panecillos acero inoxidable  
 102  
 dispensador de salsa 518  
 dispensador de zumo 20, 39-46, 49-51, 53  
 dispensador en escalera acero inoxidable  
 104-105  
 dispensador isotérmico 46  
 dispensador mixto zumo y leche  
 20, 39-46, 49  
 divisor 356

**E**  
 embudo 413, 512  
 embudo dosificador 506  
 enfriador de botellas 21, 62, 416-417,  
 419-425, 429, 453  
 enfriador de caviar 118, 305  
 enfriador múltiple 21, 62, 453  
 escurridor de fritos 505  
 espátula 478, 482-484, 499-500  
 espátula plancha 501  
 especiero 293-300, 518  
 espumadera 479, 482  
 espumadera para fritos 505  
 estación de desinfección 98  
 estación de empanado 513  
 estación pan 94  
 esterilla antideslizante 170  
 esterilla escurridora 451  
 etiquetas 74, 342-343, 345, 348  
 expositor 123, 314  
 expositor buffet frío 18, 29, 30-31, 61, 447  
 expositor buffet frío acero inoxidable  
 28-29, 33-34  
 expositor de buffet 66, 71-74,  
 76-77, 79-83, 85-92, 100, 102, 106-109,  
 115, 176, 205, 253, 326, 364, 374-375  
 expositor de buffet acero inoxidable 176  
 expositor de buffet madera 71-73, 76-77,  
 86-88, 109  
 expositor de buffet metal 73, 79-83, 85,  
 89-90, 109, 115, 206  
 exprimidor cítricos 445-446, 513

**F**  
 fiambarrera 537  
 flaneras 509  
 florero 313  
 fuente de servicio 110  
 fuente en forma de hoja de palmera  
 melamina 244-245

fuente en forma de hoja melamina  
 201, 217, 244  
 fuente para la mesa 115, 270, 272  
 funda de frío 425

**G**  
 GN bandeja 15, 25, 71, 110-113, 127,  
 144-145, 234, 405  
 GN bandeja acero inoxidable  
 110-113, 234  
 GN bandeja de pizarra natural  
 24-25, 128-129  
 GN bandeja melamina 25, 71, 163-164,  
 166, 170, 178, 180, 183-184, 186, 188,  
 191, 194-195, 197-198, 206, 211-212,  
 215, 220, 227, 231, 237-239, 243  
 GN bandeja party 123  
 GN bandeja porcelana 127, 405  
 GN campana 113, 191, 363, 524-526  
 GN cesta 16, 352, 354, 359-361, 363  
 GN cesta metal 371-372  
 GN cesta polipropileno 352, 354, 359-361  
 GN Chafing Dish 378, 381-382,  
 385-386, 389-390  
 GN cubeta 15, 24, 111, 396, 398-399,  
 402-403, 405-407  
 GN cubeta acero inoxidable 111, 398-399  
 GN cubeta para hornos de convección 404  
 GN cuenco melamina 163, 166, 168, 209  
 GN dispensador buffet en escalera 83-84  
 GN escurridor 401-402  
 GN expositor buffet acero inoxidable 28  
 GN porta cubiertos 151, 359, 404, 410  
 GN rejilla 404  
 GN set buffet 113, 405, 407  
 GN soporte para buffet 17, 85, 206, 364  
 GN tabla de servir 132  
 GN tapa 400-403, 406  
 granulado térmico 395

**H**  
 hormigón 40, 76, 157, 193-194, 294,  
 307, 312-313, 341, 424, 474  
 huevera 256, 304

**I**  
 infusor de té, pinza con malla 463

**J**  
 jarra 59-60, 460-461, 507  
 jarra de agua 59  
 jarra de leche 460-461  
 jarra de vidrio 56-57, 59  
 jarra de zumo 59-60  
 jarra enfriadora 58  
 jarra graduada 507-508  
 jarra termo 54-55  
 juego de cucharas medidoras 492

**L**  
 llavero enrollable 453

**M**  
 mandolina 506  
 manoplas de panadero 510  
 mantelín 314-318  
 mantequillera 304  
 marco de acero inoxidable para placa de  
 inducción 382-384, 393  
 marco pastelero 509  
 marmita 383, 389-390  
 medidor jigger 439-441  
 mejillonera 327  
 molde de cubitos de hielo esféricos 448  
 molde de pizza 519, 521  
 molde para cubitos de hielo 456  
 molinillo de pimienta 285-292  
 molinillo de sal 285-292, 505  
 molino de especias 285-290  
 mortero 444  
 Moscow Mule taza 429-431  
 multibox 93

<b>O</b>	
olla pequeña de servir	118, 268, 272-273
organizador de bar	452
<b>P</b>	
pajas	450
pala	495, 511
pala de hielo	448
pala de pizza	502, 510
pala de tartas	483, 485
pala para harina	510
paleta para servir	269, 464
paleta pastelera	499
panera	367-369, 373
papel alimenticio	132, 136, 282, 284
papelera de sobremesa	335-336, 338
pelador reversible	496-497
picadora de hielo	448
pie porta champañera / vino	418
pinchanotas	514
pinza	449, 479, 486-488, 490-491
pinza bogavante	502
pinza de emplatador	449, 489
pinza ensalada	479, 486-487, 490
pinza espaguetis	479, 486, 488
pinza exprime limón	463
pinza para aperitivos	488
pinza para cubitos de hielo	449
pinza para espárragos	486
pinza para pasteles	486, 490-492
pinza universal	486
pizarra	24-25, 86, 91, 121, 128-131, 133-134, 146, 212, 214, 251, 277-279, 281, 290, 468
placa de inducción	78, 379-380, 387, 393
plato esmaltado	319
plato melamina	144, 162, 164, 172, 177, 179, 181-182, 184, 186, 189, 196, 200, 218, 221, 240, 246-247, 253, 255-256, 261
plato para el aperitivo	234
plato para pasta melamina	243
polvoreador	291-292
porcelana	379, 384
porcionador de pastel	483
porta botellas	425
porta cubiertos	21, 105-106, 150-154, 187, 334-337, 339, 364-365, 410-411
porta cubiertos melamina	105
porta cuenta	333, 470
porta menú	340-346
porta vasos de cerveza	425
porta-tarjetas	342-346
portafichas	514
portavelas antiviento	312
posavasos acero inoxidable	333
posavasos corcho	520
posavasos pizarra natural	131, 290
prensa de limón	446, 513
punteo de buffet	72
<b>Q</b>	
quesera parmesano	298
<b>R</b>	
rack de copas	418, 433
rack dispensador de cuencos	81
rebanador de queso	498
recipiente de ingredientes	452
recipiente organizador	409
recipiente para masa	412, 521
recoemigas	332, 470
reposa cuchara	256, 395
resistencia	53, 385-386, 392-394
ribeteador de vasos	448
rizador	141, 498, 506
rotulador de tiza	348
<b>S</b>	
sacacorchos	457

salsera	331
salsera acero inoxidable	74
salsera melamina	74-75
salsera porcelana	75
sartén de hierro fundido	270
señal de advertencia	521, 535
service tower	106
servidor de ensalada	494
servilletero	155-157
servilleteros/aros	333
set de buffet	35, 113, 121
set de buffet refrigerado	14, 18, 27, 30-33, 35-38
set para fondue	305, 349, 391, 436
set para ponche caliente	305, 349, 391, 435-436
set para servir	160-161, 209
set rolltop	120-121, 130
set rolltop para queso	120
snackbox	254, 269, 283, 284, 537
soplete de cocina para flambeo	463, 502
soprote a pedal	475
soprote campana	103
soprote cucuruchos	515
soprote de pretzels o salchichas	86, 141
soprote para botella de vino	425
soprote para brochetas	30
soprote para paste	120, 130, 146-148, 185, 213, 252, 329
soprote para tablas de cortar	515
soprote platos	82, 85, 89-92, 326
superbox	22-25
<b>T</b>	
tabla de corte	23, 94-95, 142
tabla de servir	132-137, 139-141, 276, 279-281, 468
tabla para cortar	15, 23, 94-95, 100, 445
tabla para el buffet	132, 140-141
tapa	19, 34, 160-161, 171, 237, 241-242, 249, 532-534
tapa acero inoxidable	325, 400-401
tapa hermética	19, 34, 327
tapete escurridor	451
tapón antipolvo	453
tapón vertedor	455
tarjetas	342
tarros gourmet	322
taza	268, 426-434
taza de café	256
taza melamina	256
tenedor de carne	480-481, 485
tenedor de ensalada	484
tenedor de servicio	480-481, 485
tetera ASIA	63, 461
timbre	466
tubo enfriador para cubitos	40
<b>V</b>	
vaciador de melón redondo	496
vaso agitador	508
vaso coctelero	320
vaso mezclador vertedor	454
vaso para servir	271-276
vasos	41-45, 268, 426-428
vertedor continuo	455
vertedores	455
vitrina de buffet	26-29, 36-37, 97
vitrina de buffet acero inoxidable	28-29
vitrina de mostrador	97, 101
<b>W</b>	
Weck-botellas	70, 82, 321-326

## FRANÇAIS

<b>item</b>	<b>pág.</b>
<b>A</b>	
accumulateur de froid	19, 62, 535
adaptateur	401
anneau coupe-gouttes mélamine	40
anneaux à serviettes	333
ardoise	24-25, 86, 91, 121, 128-131, 133-134, 146, 212, 214, 251, 277-279, 281, 290, 468
articles en email	319-320
assiette creuse mélamine	243
assiette de présentation	332
assiette email	319
assiette mélamine	144, 162, 164, 172, 177, 179, 181-182, 184, 186, 189, 196, 200, 218, 221, 240, 246-247, 253, 255-256, 261
assiette pour apéritif	234
<b>B</b>	
bac	412
Bain-Marie	392
barre aimantée pour couteaux	514
barre porte-bons	514
base bois	22-25, 94, 136, 139, 153-154, 283, 306-309, 334
bassine à glace	61, 419-420
Bento Box	174
béton	40, 76, 157, 193-194, 294, 307, 312-313, 341, 424, 474
beurrer	304
boîte à épices	518
boîte à ingrédients	452
boîte à lunch	537
boîte à œufs	511
boîte à pain pour le buffet	355, 365-366, 369
boîte à thés et infusions	93
boîte de tri	93
boîte distributrice	17, 70
boîte-repas	254, 269, 283-284
bol acier inox	19, 114, 266-267, 273, 373-374
bol aluminium	274, 370
bol béton	76
bol bois	138-139, 275-276
bol email	304, 319-320
bol en verre	79-81, 534
bol mélamine	19, 34, 81, 160, 162-163, 165, 167-169, 171, 177, 179, 181-182, 185, 187-188, 190, 192-194, 197, 199, 201, 204, 207-210, 213, 217-219, 221-227, 229-237, 240-248, 250, 253, 255, 259-262
bol mélangeur	320
bol mini	248, 259-262
bol récupérateur de capsules	62
bol réfrigéré	19, 32-34
bordeur à verres	448
bouchon anti-poussières et anti-insectes	453
bouchon verseur	455
boule à thé avec pince	463
bouteille	58, 60, 536
bouteille „store & pour“	454
bouteille de combustible liquide	394
bouteille isotherme	54-55
bouteille verseuse souple	515-517
brosse lave	449
broyeur à glaçons	448
<b>C</b>	
caddy	93, 136, 153-154, 306-309, 334, 452
caddy de table	153-154, 306-309, 334

cadre support inox pour plaque induction	382-384, 393
caisson thermo	36-38
carafe en verre	56-57, 59
casserole	115, 270, 272
casserole à moules	327
cendrier	471-475
cendrier sur pied	475
cercle à gâteaux	509
cercle à mousse rond	507
Chafing Dish	378-379, 381-382, 384-386, 388-390
Chafing Dish Rolltop	385-386, 389
chalumbeau e cuisine	463, 502
chandelier	310-312
chariot	409
chariot de service	408-409
chauffe-plat	394
chauffe-thière	63
chevalets de table	347
chinois	505-506
cloche	16-17, 103, 117-119, 121, 149, 204, 253, 527-531
cloche demi-sphère	332
cloche rolltop	16-17, 117, 120, 253, 392, 526-527
cloche rolltop acier inox	392
coquetier	256, 304
corbeille	367-369, 373
corbeille à baguette	357, 364
corbeille à petits pains	210, 251, 355
corbeille acier inox	373
corbeille de buffet	16, 176, 356, 358, 361-363
corbeille de service	274, 358, 370
corbeille métal	369, 371-375
corbeille polypropylène	353, 356-358, 361-363, 366
coupe-œufs	502
coupe-pâte	501
coupe-pizza	497, 502, 521
couteau à huîtres	498
couteau à tarte	483
couteau à tartiner	501
couteau cannelé	445, 498
couteau cocktail	445, 497
couteau tranche-fromage	498
couteau zesteur	496
couteau zesteur cannelé	496
couvercle	19, 34, 160-161, 171, 237, 241-242, 249, 532-534
couvercle acier inox	325, 400-401
couvercle hermétique	19, 34, 327
couvert à salade	494
cuillère	479-480, 485, 493-495
cuillère à cocktail	442
cuillère à glace	492, 515
cuillère à miel	495
cuillère à salade	255, 483-484
cuillère à sauce	480, 483, 485, 493
cuillère à spaghetti	480, 482
cuillère de service	255, 479-485
cuillère gourmet	268, 493, 495
cuillère party	228, 257-258
cuillère pâtisserie	492
<b>D</b>	
décapsulateur	62, 457
dénoyateur	497
dérouleur de film	514
distributeur de petits pains acier inox	102
distributeur à jus de fruit	20, 39-46, 49-51, 53
distributeur à lait	20, 39-46, 49-52, 460-461
distributeur de boisson isothermique	46



distributeur de boissons	39-47, 452	mesure jigger	439-441	plateau feuille mélamine	201, 217, 244	réciptent bain-marie	506
distributeur de café acier inox	53, 392	Moscow Mule gobelet	429-431	plateau mélamine	25, 71, 163-164, 166, 170, 178-180, 183-186, 188, 191, 193-199, 205-208, 211-217, 219-221, 225-228, 231, 235, 237-239, 253, 262, 290	réciptent de table	409
distributeur de céréales	21, 64-67	moule à boule ronde simple	496	plateau party	123	résistance	53, 385-386, 392-394
distributeur de céréales acero inox	65-66	moule à glaçons	456	plateau self-service et snacks	136, 145, 469	<b>S</b>	
distributeur de désinfectant	98	moule à glaçons en boules	448	plateau sous-verre acier inox	333	sac à lunch	373
distributeur mixte à lait et à jus de fruit	20, 39-46, 49	moule à pizza	519, 521	plateau sushi mélamine	184, 225-226	saucière	331
doseur à sauce	518	moules à flan	509	plateau verre	121	saupoudreuse à épices	291-292
<b>E</b>		moulin à épices	285-290	plateaux réfrigérés	14, 27	seau	413, 511
écumoire	479, 482	moulin à poivre	285-292	plucheur droitier/gaucher	497	seau à champagne	61, 416-417, 419, 421-422
écumoire à friture	505	moulin à sel	285-292, 505	pochette à serviettes	318	seau à glaçons	16, 447
entonnoir	413, 512	multibox	93	pochette couverts	318	seau à glaçons isothermique	416, 446
entonnoir à piston	506	<b>N</b>		poêle en fonte	270	seau à vin	61, 416-417, 419, 421-422
étagère	73, 87-89, 91-92, 131, 233	organisateur „bar caddy“	452	pompe de dosage	518	service à fondue	305, 349, 391, 436
étiquettes	74, 342-345, 348	<b>P</b>		pont de buffet	72	service à parmesan	298
<b>F</b>		pailles	450	porcelaine	379, 384	service à punch	305, 349, 391, 435-436
flacon pulvérisateur	300, 454	panier à œufs	363	porte verres à bière	425	set apéritif	242, 293-300
forme à gateaux	509	panier pour le service sur table	271	porte-addition	333, 470	set cloche à fromage	120
fouet	503	panneau d'avertissement	521, 535	porte-bols	81	set de service	160-161, 209
fourchette à salade	484	papier alimentaire	132, 136, 282, 284	porte-bouteille à vin	425	set de table	314-318
fourchette à viande	480-481, 485	pare-haleine	96, 99, 102	porte-bouteilles	425	set rolltop	120-121, 130
fourchette de service	480-481, 485	paroi de séparation	356	porte-cartes	340-346	set thermo	31
frisette	141, 498, 506	passoire	503-504	porte-cartes de table	342-346	shaker	437-438
<b>G</b>		peleur	496	porte-clés avec câble à enroulement	453	snackbox	254, 269, 283-284, 537
gants de boulanger	510	pelle	495, 511	porte-épices	293-300	sonnette	466
GN bac	15, 24, 111, 396, 398-399, 402-403, 405-407	pelle à farine	510	porte-sachets de sucre	462	soucoupes ardoise naturelle	131, 290
GN bac acier inoxydable	111, 398-399	pelle à gâteau	483, 485	porte-serviettes	155-157	soucoupes liège	520
GN bac pour fours à convection	404	pelle à glaçons	448	pose-cuillère	256, 395	spatule	478, 482-484, 499-500
GN bol mélamine	163, 166, 168, 209	pelle à pizza	502, 510	pot	68-70	spatule coudée spéciale grill	501
GN Chafing Dish	378, 381-382, 385-386, 389-390	petits chevalets de buffet	341, 345, 347	pot à épices	291-292	spatule pâtissière	499
GN cloche	113, 191, 363, 524, 525, 526	pichet	59-60, 460-461, 507	pot à sauce acier inox	74	stand de désinfection	98
GN corbeille	16, 352, 354, 359-361, 363	pichet à café	461	pot à sauce mélamine	74-75	station de panure	513
GN corbeille métal	371-372	pichet à eau	59	pot à sauce porcelaine	75	station pain	94
GN corbeille polypropylène	352, 354, 359-361	pichet à jus de fruit	59-60	pot de moutarde	295	sucrier	301-303, 458-460, 463
GN couvercle	400-403, 406	pichet à lait	460-461	pot verseur universel	302, 458	superbox	22-25
GN égouttoir	401-402	pichet gradué	507-508	poubelle à pédale	475	support à bretzel ou à saucissons	86, 141
GN grille	404	pichet rafraîchisseur	58	poubelle de table	335-336, 338	support à cornets	515
GN planche de service	132	pied pour seau à champagne / vin	418	présentoir	123, 314	support cloche	103
GN plateau	15, 25, 71, 110-113, 127, 144-145, 234, 405	pied pour seau à vin	418	présentoir à assiettes	82, 85, 89-92, 326	support multiple acier inox	104-105
GN plateau acier inox	110-113, 234	pilon muddler	444	présentoir à gâteaux	120, 130, 146-148, 185, 213, 252, 329	support pour brochettes	305
GN plateau ardoise naturelle	24-25, 128-129	pince	449, 479, 486-488, 490-491	présentoir à sandwiches	101	<b>T</b>	
GN plateau buffet acier inox	28	pince à apéritif	488	présentoir buffet	29, 35, 66, 71-74, 76-77, 79-83, 85-92, 100, 102, 106-109, 113, 115, 121, 176, 205, 253, 326, 364, 374-375	tamis	443, 445, 503-504
GN plateau mélamine	25, 71, 163-164, 166, 170, 178, 180, 183-184, 186, 188, 191, 194-195, 197-198, 206, 211-212, 215, 220, 227, 231, 237-239, 243	pince à asperges	486	présentoir buffet acier inox	176	tamis cocktail	443, 445
GN plateau party	123	pince à dresser	449, 489	présentoir buffet bois	71-73, 76-77, 86-88, 109	tapis antidérapant	170
GN plateau porcelaine	127, 405	pince à gâteaux	486, 490-492	présentoir buffet en escalier	79-80, 83	tapis de bar	451
GN présentoir buffet	206, 364	pince à glaçons	449	présentoir buffet froid	14, 18, 27, 30-33, 35-38, 61, 447	tapis égouttoir	451
GN présentoir buffet en escalier	83, 84	pince à homard	502	présentoir buffet froid acier inox	28-29, 33-34	tasse à café	256
GN range couverts	151, 359, 404, 410	pince à salade	479, 486-487, 490	présentoir buffet métal	73, 79-83, 85, 89-90, 109, 115, 206	tasse à remuer	508
GN set buffet	113, 405, 407	pince à spaghetti	479, 486, 488	presse citron	445-446, 513	tasse mélamine	256
GN support buffet	17, 85	pince presse citron	463	<b>R</b>		théière ASIA	63, 461
gobelet	41-45, 268, 426-428	pince universelle	486	rack porte-verres	418, 433	tire-bouchons	457
gobelet à apéritif	271-276	pinceau pâtissier	513	rack pour planches à découper	515	tour de service	106
gourde	536	pique-bons	514	rafraîchisseur	21, 62, 453	truelle de service	269, 464
gravier thermique	395	planche à découper	15, 23, 94-95, 100, 142, 445	rafraîchisseur de bouteilles	21, 62, 416-417, 419-425, 429, 453	tube pour glaçons	40
<b>H</b>		planche à découper buffet	132, 140-141	rafraîchisseur de caviar	118, 305	<b>V</b>	
housse isotherme	425	planche de service	132-137, 139-141, 276, 279-281, 468	ramasse-miettes	332, 470	vase soliflor	313
<b>J</b>		plaque à induction	378-380, 387, 393	ramequin	223, 248, 250	verre mélangeur	454
jeu de cuillère à mesure	492	plaque à pâtisserie	404, 509	range couverts	21, 105-106, 150-154, 187, 334-337, 339, 364-365, 410-411	verres gourmet	322
<b>L</b>		plat à gâteau acier inox	329-330	range couverts mélamine	105	verseurs continus	455
louche	479-480, 482	plat à gâteau bois	135, 147-148, 328, 330	réchaud à beurre et sauce	305	vitrine de buffet	26-29, 36-37, 97
louche de service	483	plat à gâteau mélamine	146, 252, 329-330	réciptent à pâte	412, 521	vitrine de buffet acier inox	28-29
<b>M</b>		plat à sauter	268			vitrine de comptoir	97, 101
mandoline	506	plat ardoise naturelle	24-25, 128-131, 277-278, 290			<b>W</b>	
marmite	383, 389-390	plat de service	110			Weck-bouteilles	70, 82, 321-326
marmite petite de servir	118, 268, 272-273	plat pour la table	115, 270, 272				
marqueur à la craie liquide	348	plateau	15, 94, 112-119, 124-126, 143-145, 267, 280, 282, 355, 464-470				
		plateau acier inox	15, 112-119, 124, 126, 267, 282, 464-466				
		plateau bois	103, 121, 122, 145, 280, 468-469				
		plateau feuille de palme mélamine	244-245				







# Buffet & Display



# FRAMES



Die reduzierte, archetypische Formsprache von FRAMES nimmt sich elegant zurück und lässt damit viel Raum für die Inszenierung der Buffet-Speisen. Ein scheinbarer Widerspruch löst sich auf: das Design ist zeitgemäß und zeitlos zugleich.

Design in detail – The classic minimalist visual style of FRAMES is elegantly understated, leaving plenty of potential for creating appealing buffet arrangements. Its design transcends what at first seems to be an irreconcilable paradox, being at once both timeless and highly contemporary.



## Kühltablets SET 1 „FRAMES“

cooling plates  
bandejas refrigeradas  
plateaux réfrigérés



GN 1/1 Basiselement, GN 1/1 Edelstahl Tablett 18/10, Kühlakku  
GN 1/1 base element, GN 1/1 stainless steel platter 18/10, cooler  
elemento básico GN 1/1, bandeja GN 1/1 de acero inoxidable 18/10, acumulador de frío  
élément de base GN 1/1, plateau GN 1/1 inox 18/10, accumulateur de froid

	cm	↑ cm	GN	Farbe / Colour	
12940	53 x 32,5	8,5	1/1		stainless steel
14940	53 x 32,5	8,5	1/1		wenge wood
13940	53 x 32,5	8,5	1/1		maple wood



## Kühltablets SET 2 „FRAMES“

cooling plates  
bandejas refrigeradas  
plateaux réfrigérés



GN 1/1 Basiselement, GN 1/1 Edelstahl Tablett 18/10, Rolltop-Haube, Kühlakku  
GN 1/1 base element, GN 1/1 stainless steel platter, rolltop cover, cooler  
elemento básico GN 1/1, bandeja GN 1/1 de acero inoxidable 18/10, campana rolltop, acumulador de frío  
élément de base GN 1/1, plateau GN 1/1 inox 18/10, cloche rolltop, accumulateur de froid

	cm	↑ cm	GN	Farbe / Colour	
12941	53 x 32,5	27,5	1/1		stainless steel
14941	53 x 32,5	27,5	1/1		wenge wood
13941	53 x 32,5	27,5	1/1		maple wood



**Schneidebrett „FRAMES“**

chopping Board  
tabla para cortar  
planche à découper



**Ahorn, massiv**  
maple wood, solid  
madera de arce, masivo  
bois d'érable, massif

	cm	↑ cm	GN	
13955	53 x 32,5	2,5	1/1	
13960	53 x 32,5	2,5	1/1	gerillt

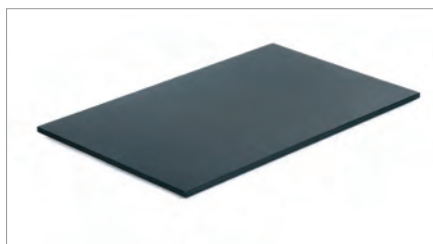

**Schneidebrett „FRAMES“**

chopping Board  
tabla para cortar  
planche à découper



	cm	↑ cm	GN
17910	53 x 32,5	2,5	1/1

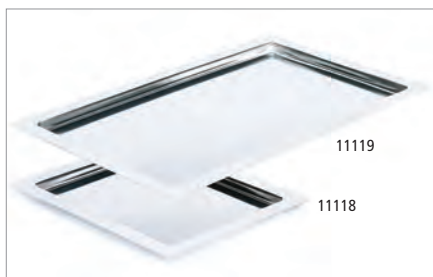

**GN Edelstahl Tablett „FRAMES“**

GN stainless steel platter  
GN bandeja acero inoxidable  
GN plateau acier inox



	cm	↑ cm	GN
11119	53,0 x 32,5	2	1/1
11118	32,5 x 26,5	2	1/2



**GN Tablett „FRAMES“**

GN tray  
GN bandeja  
GN plateau



	cm	↑ cm	GN
84046	53,0 x 32,5	2	1/1
84047	32,5 x 26,5	2	1/2
84048	32,5 x 17,6	2	1/3



**GN Tablett „FRAMES“**

GN tray  
GN bandeja  
GN plateau



	cm	↑ cm	GN
82355	53,0 x 32,5	2	1/1
82356	32,5 x 26,5	2	1/2
82357	32,5 x 17,6	2	1/3



**GN Wanne „FRAMES“**

GN tray  
GN bandeja  
GN plateau



	cm	↑ cm	GN
17922	53 x 32,5	8	1/1

## FRAMES



### Korb „FRAMES“

GN basket  
GN cesta  
GN corbeille



stabile Ausführung mit Edelstahldraht im Rand zur Stabilisierung  
very solid with stainless steel wire frame to stabilize the basket  
muy resistente con refuerzo de alambre inox  
très résistante avec son fil de renfort inox

	cm	↑ cm	GN
40291	53,0 x 32,5	6,5	1/1
40290	32,5 x 26,5	6,5	1/2
40293	53,0 x 32,5	10,0	1/1
40292	32,5 x 26,5	10,0	1/2



### Buffetkorb „FRAMES“

buffet basket  
cesta de buffet  
corbeille de buffet



Polyrattan, mit Haubenschiene (ohne Haube)  
polyrattan, with frame to fix the (without cover)  
polyrattan, con fijación para campana (sin campana)  
polyrattan, avec fixation pour la cloche (sans cloche)

	Ø cm	↑ cm
40295	40	12,5



### GN Basket „FRAMES“

GN basket  
cesta GN  
corbeille GN



Polyrattan, mit Haubenschiene (ohne Haube)  
polyrattan, with frame to fix the (without cover)  
polyrattan, con fijación para campana (sin campana)  
polyrattan, avec fixation pour la cloche (sans cloche)

	cm	↑ cm
40294	56,5 x 36,0	10



### Rolltop-Haube „FRAMES“

rolltop cover  
campana abatible  
cloche basculante



	Ø cm	↑ cm
18389	38	20



### Eisbox „FRAMES“

ice box  
bandeja para hielo para buffet  
caisse à glaçons pour le buffet



3-teilig: 1 Basiselement Wenge + 1 Polystyrolwanne + 1 Tropfgitter  
3 pcs. set: 1 box wenge + 1 plastic deep tray + 1 drainer plate  
set de 3: 1 cajón color wengué, 1 cubeta plástico, 1 rejilla  
set de 3: 1 caisson couleur wengué, 1 bac plastique, 1 plaque perforée

	cm	↑ cm	GN	Farbe / Colour
14970	53 x 32,5	12,5	1/1	■





**GN 1/1 Rolltop-Haube „FRAMES“**

GN 1/1 rolltop cover  
GN 1/1 campana abatible  
GN 1/1 cloche basculante



**verchromter Zinkdruckguss-Griff**

chrome plated metal handle  
mango cromado de fundición a presión de zinc  
poignée en zinc moulé sous pression chromé

	cm	↑ cm	GN
11018	53 x 32,5	17	1/1



**Besteck- / Universal-Box, 2-teilig „FRAMES“**

cutlery tray, 2 pcs.  
cubertero o cajón multi-usos, 2pz.  
caisson à couverts ou multi-usages



**Buche massiv, Wenge, 4 Fächer, inklusive herausnehmbaren Einsatz**

wood wenge, 4 compartments  
madera de haya maciza, color wengué, 4 compartimentos, separadores removibles  
hêtre massif, couleur wengé, 4 compartiments, séparateurs amovibles

	cm	↑ cm	GN	Farbe / Colour
14956	53 x 32,5	11	1/1	■

**Einsatz für GN 1/1 „FRAMES“ / insert for GN1/1 „FRAMES“ / interior para GN1/1 „FRAMES“ / insert pour GN1/1 „FRAMES“**

	cm	↑ cm	Farbe / Colour
14954	48,5 x 28	8	■



**Gestell für GN 1/1 „FRAMES“**

serving stand  
cubertero o cajón multi-usos  
caisson à couverts ou multi-usages



**Buche massiv, Wenge**

wood, wenge  
madera de haya maciza, wengué  
hêtre massif, wengé

	cm	↑ cm	Farbe / Colour
14953	57,5 x 27,5	22	■

**vielseitig einsetzbar für alle GN 1/1 Artikel**

**passendes Kühltablett Set**



**passendes Kühltablett Set**



**passende Besteck / Universal-Box GN 1/1**



Mit hohem Anspruch an Design und Funktionalität haben wir das Buffet-System „Bridge“ für Sie entwickelt. Die in den Holzoberflächen Ahorn und Wenge erhältlichen Artikel sind in ihren Höhen und ihren Volumina optimal aufeinander abgestimmt und gewährleisten einen einfachen und sicheren Umgang in Ihrem Gastronomiealltag.

The collection “Bridge” is bringing perfectly coordinated components for an uncomplicated and organized buffet system, finalizing in an unique buffet scenery. All pieces combine perfectly with one another in their variations of sizes and volumes. The wooden items are available in 2 colors, maple or wenge. A simple and safe handling is guaranteed.

Una colección universal para un buffet único: un Sistema funcional y fácil de componer, asociado a la elegancia de su exclusivo diseño. Los elementos se combinan a la perfección entre variaciones de Alturas y volúmenes, realizando sus propuestas y composiciones culinarias y modelando el paisaje del buffet. Las piezas están disponibles en 2 colores, wengué o arce. Manejo sencillo y seguro.

Une collection universelle pour une présentation unique de votre buffet: fonctionnel et facile à composer, ce système est à la fois pratique, simple et spectaculaire par son élégant design. Les différents éléments se marient à la perfection pour construire sans difficulté différentes compositions, variant les hauteurs et les volumes et mettant en valeur vos créations culinaires. Les pièces sont disponibles en deux couleurs, bois wengué ou érable.



**Kühlbox „BRIDGE“**  
refrigerated buffet display  
set de buffet refrigerado  
présentoir buffet froid



Set bestehend aus: 1 Gestell aus Ahorn oder Wenge, 1 Behälter aus Kunststoff, 1 GN1/1 Tablett aus Melamin, 1 Kühlakku, 1 Rolltophaube (fix montiert)  
set consists of: 1 base element maple or wenge, 1 plastic insert black, 1 GN1/1 tray melamine, 1 cooler, 1 cover (fixed)  
set compuesto por: 1 soporte de madera arce o wengué, 1 cubeta de plástico, 1 bandeja de melamina GN 1/1, 1 acumulador de frío, 1 campana rolltop (fija)  
set composé de: 1 support en bois érable ou wengué, 1 bac plastique, 1 plat en mélamine GN 1/1, 1 accumulateur de froid, 1 cloche rolltop (fixe)

	cm	↑ cm	Farbe / Colour	
13990	63,5 x 42,5	31		ahorn wood
14990	63,5 x 42,5	31		wenge wood

**Kühlschale „BRIDGE“**

cooling bowl  
bol refrigerado  
bol réfrigéré



4-teilig: 1 Gestell aus Ahorn oder Wenge, 1 Behälter aus Edelstahl,  
1 Schale aus Melamin (Ø 14 cm o. 23 cm), 1 Kühlakku

4 pcs.: 1 base element maple or wenge, 1 bowl stainless steel,  
1 bowl melamine (Ø 14 o. 23 cm), 1 cooler

set de 4: 1 soporte de madera arce o wengué, 1 cuenco

de acero inoxidable, 1 cuenco de melamina (ø 14 cm o 23 cm), 1 acumulador de frío

set de 4: 1 support en bois érable ou wengé, 1 bol en acier inox, 1 bol en mélamine  
(ø 14 cm ou 23 cm), 1 accumulateur de froid

	cm	↑ cm	ltr.	Farbe / Colour
13980	18,5 x 18,5	10	0,5	—
13981	27,5 x 27,5	14	2,5	—

	cm	↑ cm	ltr.	Farbe / Colour
14980	18,5 x 18,5	10	0,5	—
14981	27,5 x 27,5	14	2,5	—

**Edelstahlschale „BRIDGE“**

stainless steel bowl  
cuenco acero inoxidable  
bol acier inoxydable



	Ø cm	↑ cm
30050	14	8,5
30052	23	13,5

**Schale „CASUAL MAXI“**

bowl  
cuenco  
bol



	Ø cm	↑ cm	ltr.	Farbe / Colour
83700	14	6,5	0,5	—
83702	23	10,5	2,5	—

	Ø cm	↑ cm	ltr.	Farbe / Colour
83701	14	6,5	0,5	—
83703	23	10,5	2,5	—

**Frischhaltecover**

airtight cover  
tapa hermética  
couvercle hermétique



	Ø cm
10890	14
10887	23

**Kühlakku / cooler / acumulador de frío / accumulateur de froid**

	Ø cm	↑ cm
10661	10,5	2,0
10777	15,0	2,5





Milchdispenser „BRIDGE“

milk dispenser  
dispensador de leche  
distributeur à lait



Edelstahl Dispenser mit 1 Kühlakku im Standfuß inkl. touchless adapter

stainless steel dispenser with 1 cooling element in stand incl. touchless adapter  
dispensador de acero inoxidable con 1 acumulador de frío en la base y con adaptador sin contacto para grifo  
distributeur en acier inox avec 1 accumulateur de froid dans le socle et avec adaptateur sans contact manuel

	cm	↑ cm	ltr.	Farbe / Colour	
10836	31 x 20	39	3		Ahorn / maple
10838	39 x 22	45	5		Ahorn / maple



Milchdispenser „BRIDGE“

milk dispenser  
dispensador de leche  
distributeur à lait



Edelstahl Dispenser mit 1 Kühlakku im Standfuß inkl. touchless adapter

stainless steel dispenser with 1 cooling element in stand incl. touchless adapter  
dispensador de acero inoxidable con 1 acumulador de frío en la base y con adaptador sin contacto para grifo  
distributeur en acier inox avec 1 accumulateur de froid dans le socle et avec adaptateur sans contact manuel

	cm	↑ cm	ltr.	Farbe / Colour	
10837	31 x 20	39	3		Buche / beech
10839	39 x 22	45	5		Buche / beech



Saftdispenser „BRIDGE“

juice dispenser  
dispensador de zumo  
distributeur à jus



Kühlung durch 2 Kühlakkus von oben und unten

cooling with 2 cooling elements from the top and base  
2 acum. de frío 1 en la base y 1 en la tapa  
2 plaques de froid 1 dans le couvercle, 1 dans le socle

	cm	↑ cm	ltr.	Farbe / Colour	
10870	31,0 x 20	42	4		Ahorn / maple
10871	35,5 x 22	50	6		Ahorn / maple

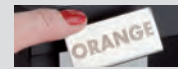

inkl. 3 Magnetschilder: ORANGE, APPLE, GRAPEFRUIT  
including 3 magnetic signs: ORANGE, APPLE, GRAPEFRUIT



Saftdispenser „BRIDGE“

juice dispenser  
dispensador de zumo  
distributeur à jus



Kühlung durch 2 Kühlakkus von oben und unten

cooling with 2 cooling elements from the top and base  
2 acum. de frío 1 en la base y 1 en la tapa  
2 plaques de froid 1 dans le couvercle, 1 dans le socle

	cm	↑ cm	ltr.	Farbe / Colour	
10872	31,0 x 20	42	4		Wenge / wenge
10873	35,5 x 22	50	6		Wenge / wenge



inkl. 3 Magnetschilder: ORANGE, APPLE, GRAPEFRUIT  
including 3 magnetic signs: ORANGE, APPLE, GRAPEFRUIT



4,5 ltr.

**Cerealienspender „BRIDGE“**

cereal dispenser  
dispensador de cereales  
distributeur de céréales



Behälter herausnehmbar, „Feierabend-Deckel“ für das aromadichte Lagern, portionieren durch einfaches Drehen

removable canister, special lid to keep the cereals fresh, easy to use, rotate the button to get the muesli

contenedor movible, tapa especial para mantener los cereales frescos, fácil de usar, se gira el pomo para servir los cereales

réceptif amovible, couvercle spécial pour conserver les céréales, usage facile en tournant le bouton

	cm	↑ cm	ltr.	Farbe / Colour	
13987	21 x 20	55,5	4,5		Ahorn / maple



4,5 ltr.

**Cerealienspender „BRIDGE“**

cereal dispenser  
dispensador de cereales  
distributeur de céréales



Behälter herausnehmbar, „Feierabend-Deckel“ für das aromadichte Lagern, portionieren durch einfaches Drehen

removable canister, special lid to keep the cereals fresh, easy to use, rotate the button to get the muesli

contenedor movible, tapa especial para mantener los cereales frescos, fácil de usar, se gira el pomo para servir los cereales

réceptif amovible, couvercle spécial pour conserver les céréales, usage facile en tournant le bouton

	cm	↑ cm	ltr.	Farbe / Colour	
14987	21 x 20	55,5	4,5		Wenge / wenge



14995



13995

**Besteckbehälter „BRIDGE“**

cutlery organizer  
cajón para cubiertos  
bac à couverts



2 teiliges Set: 1 Gestell, 1 Besteckbehälter (Nr. 11955), herausnehmbar

2 pcs.: 1 base element, 1 removable plastic container (item 11955)

set de 2: 1 soporte, 1 cajón para cubiertos (ref. 11955), extraíble

set de 2: 1 support, 1 bac à couverts (réf. 11955), amovible

	cm	↑ cm	Farbe / Colour	
14995	57,7 x 37	12		Wenge / wenge
13995	57,5 x 37	12		Ahorn / maple



14985



13985

**Flaschenkühler „BRIDGE“**

bottle cooler  
enfriador  
refraîchisseur



2-teiliges Set, bestehend aus: 1 Gestell, 1 Behälter aus Edelstahl (doppelwandig)

2 pcs.: 1 base element, 1 bowl stainless steel (double-wall)

set de 2: 1 soporte, 1 cuenco de acero inoxidable (doble pared)

set de 2: 1 support, 1 bol en acier inox (double paroid)

	cm	↑ cm	Farbe / Colour	
14985	35 x 35	19		Wenge / wenge
13985	35 x 35	19		Ahorn / maple

# SUPERBOX

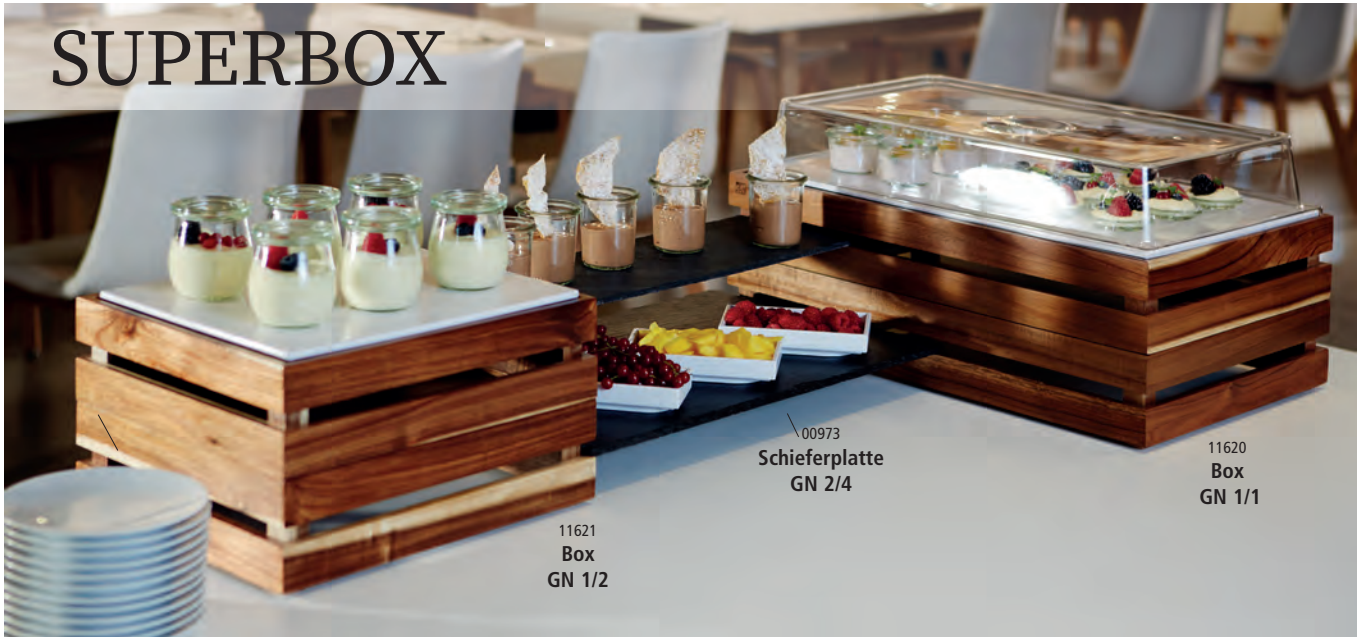

11621  
Box  
GN 1/2

00973  
Schieferplatte  
GN 2/4

11620  
Box  
GN 1/1

Die stapelbaren Wendeboxen lassen sich rutschfest stapeln und mit flachen GN Platten verbinden und einzeln nutzen. Individuell können Buffetlandschaften gebaut werden.

The stackable and non-slip reversible boxes can be connected to flat GN trays and can also be used individually. Different and individual buffet sceneries can be built up.

Las cajas girable y apilables son antideslizantes y se pueden conectar con bandejas planas GN o utilizar individualmente. Se pueden construir diferentes paisajes de buffet muy individuales.

Les boîtes de tournage empilables sont antiglissantes et peuvent être connectées avec des plateaux plats GN ou utilisées individuellement. Des paysages de buffet très personnalisés peuvent être construits.



11626

## GN 1/1 „SUPERBOX“

Akazienholz / acacia wood / madera de acacia / bois d'acacia



	cm	↑ cm	Farbe / Colour
11620	55,5 x 35	10,5	Gold
11626	55,5 x 35	10,5	Schwarz



11623

11629

## GN 2/4 „SUPERBOX“

Akazienholz / acacia wood / madera de acacia / bois d'acacia



	cm	↑ cm	Farbe / Colour
11623	55,5 x 18,5	10,5	Gold
11629	55,5 x 18,5	10,5	Schwarz



11627

## GN 1/2 „SUPERBOX“

Akazienholz / acacia wood / madera de acacia / bois d'acacia



	cm	↑ cm	Farbe / Colour
11621	35 x 29	10,5	Gold
11627	35 x 29	10,5	Schwarz



11622

## GN 1/4 „SUPERBOX“

Akazienholz / acacia wood / madera de acacia / bois d'acacia



	cm	↑ cm	Farbe / Colour
11622	29 x 18,5	10,5	Gold
11628	29 x 18,5	10,5	Schwarz





GN „SUPERBOX“

Akazienholz  
acacia wood  
madera de acacia  
bois d'acacia



	cm	↑ cm	GN	Farbe / Colour
11721	55,5 x 35,0	20	1/1	
11723	55,5 x 35,0	20	1/1	
11620	55,5 x 35,0	10,5	1/1	
11626	55,5 x 35,0	10,5	1/1	
11722	35,0 x 29,0	20	1/2	
11724	35,0 x 29,0	20	1/2	
11621	35,0 x 29,0	10,5	1/2	
11627	35,0 x 29,0	10,5	1/2	

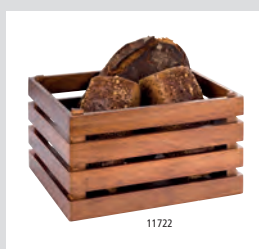

Präsentationsmöglichkeiten  
presentation examples



Brottschneidebrett

cutting board  
tabla para cortar  
planche à découper



Schneidebrett aus geöltem Walnussholz mit Antirutsch-Füßchen  
with non-slip-feet oiled walnut wood cutting board  
tabla de cortar de nogal engrasada con pies antideslizantes  
planche à découper en bois de noyer huilé avec pieds antidérapants

	cm	↑ cm	GN
00911	35,4 x 32,5	3,5	2/3

mit herausnehmbarem Krümfach  
with removable crump shelf

# SUPERBOX



## GN „SUPERBOX VINTAGE“



Akazienholz  
 acacia wood  
 madera de acacia  
 bois d'acacia

	cm	↑ cm	GN	Farbe / Colour
11715	55,5 x 35,0	10,5	1/1	■
11716	35,0 x 29,0	10,5	1/2	■
11717	29,0 x 18,5	10,5	1/4	■
11718	55,0 x 18,5	10,5	2/4	■



Präsentationsmöglichkeiten  
 presentation examples



## GN Naturschieferplatten

GN natural slate tray  
 GN bandeja de pizarra natural  
 GN plat ardoise naturelle



	cm	GN
00990	53,0 x 32,5	1/1
00991	32,5 x 26,5	1/2
00993	26,5 x 16,2	1/4
00973	53,0 x 16,2	2/4



## GN Einsatz „SUPERBOX“

GN insert  
 GN bandeja  
 GN bac supérieur



	cm	↑ cm	GN	fits to
11616	53,0 x 32,5	8,5	1/1	11620, 11626, 11700, 11715
11617	32,5 x 26,5	8,5	1/2	11621, 11627, 11701, 11716





**GN „SUPERBOX VINTAGE“**



Leichtes Holz, Tannenholz  
fir wood  
madera de abeto  
bois sapin

	cm	↑ cm	GN
11700	55,5 x 35,0	10,5	1/1
11701	35,0 x 29,0	10,5	1/2
11702	29,0 x 18,5	10,5	1/4
11703	55,0 x 18,5	10,5	2/4



**GN Tablett „ZERO“**



GN tray  
GN bandeja  
GN plateau

	cm	↑ cm	GN	Farbe / Colour
84185	53,0 x 32,5	1,5	1/1	White
84195	53,0 x 32,5	1,5	1/1	Black
84186	32,5 x 26,5	1,5	1/2	White
84196	32,5 x 26,5	1,5	1/2	Black
84188	26,5 x 16,2	1,5	1/4	White
84198	26,5 x 16,2	1,5	1/4	Black
84189	53,0 x 16,2	1,5	2/4	White
84199	53,0 x 16,2	1,5	2/4	Black



mit Antirutschfüßchen  
with non-slip feet



**GN Naturschieferplatten**



GN natural slate tray  
GN bandeja de pizarra natural  
GN plat ardoise naturelle

	cm	GN
00990	53,0 x 32,5	1/1
00991	32,5 x 26,5	1/2
00993	26,5 x 16,2	1/4
00973	53,0 x 16,2	2/4



## COOLING DISPLAY



### Buffetvitrine „TOP FRESH GN 1/1“

refrigerated buffet display  
expositor buffet frío  
plateau buffet froid



4-teilig: 1 Holzbox mit Kunststoffwanne + 1 Tablett GN 1/1 + 2 Kühllakkus

4 pcs.: 1 woodbox with plastic insert + 1 stainless tray GN 1/1 + 2 coolers

set de 4: 1 base madera + 1 bandeja inox GN 1/1 + 2 acumuladores de frío

set de 4: 1 base bois + 1 plateau inox GN 1/1 + 2 accus de froid (cloche non incluse)

	cm	↑ cm
11540	60 x 41	5

GN Rolltophaube / GN rolltop cover / GN campana rolltop / GN cloche rolltop

	cm	↑ cm	GN
11008	53 x 32,5	19	1/1 Gold-Griff

GN Rolltophaube / GN rolltop cover / GN campana rolltop / GN cloche rolltop

	cm	↑ cm	GN
11010	53 x 32,5	19	1/1 Chrom-Griff

Kühllakku / cooler / acumulador de frío / accumulateur de froid

	cm	↑ cm
10791	25 x 19	2,5



### Buffetvitrine „DOPPELDECKER“

cooling buffet display  
expositor buffet frío  
vitrine buffet



12-teilig: 2 Kästen Buchen-Holz versiegelt + 2 Tablett GN 1/1

+ 4 Kühllakkus + 4 Stangen, ohne Hauben

12 pcs.: 2 beech wood boxes waterproof + 2 trays GN 1/1

+ 4 coolers + 4 fittings, without covers

set de 12: 2 bases madera tratada + 2 bandejas inox GN 1/1

+ 4 enfriadores + 4 pies (campanas no incl.)

set de 12: 2 caissons bois traité (hêtre) + 2 plateaux inox GN 1/1

+ 4 accus + 4 pieds (cloches non incluses)

	cm	↑ cm	
11541	60 x 41	36	verchromte Stäbe / chrome plated fittings pies cromados / pieds chromés

GN Rolltophaube / GN rolltop cover / GN campana rolltop / GN cloche rolltop

	cm	↑ cm	GN
11008	53 x 32,5	19	1/1 Gold-Griff

GN Rolltophaube / GN rolltop cover / GN campana rolltop / GN cloche rolltop

	cm	↑ cm	GN
11010	53 x 32,5	19	1/1 Chrom-Griff

Kühllakku / cooler / acumulador de frío / accumulateur de froid

	cm	↑ cm
10791	25 x 19	2,5



11542

**Buche, wasserfest lackiert**  
beech wood lacquered

18388

11542

10791

**Kühl-Akkus halten Ihre Speisen bis zu 6 Stunden kühl**  
cooling system keeps the food cool for up to 6 hours

**Kühltablett „TOP FRESH RUND“**  
refrigerated buffet display  
expositor buffet frío redondo  
présentoir buffet



**3-teilig: 1 Holzbox mit Kunststoffwanne + 1 Edelstahl-Tablett Ø 38 cm + 1 Kühllakku**  
3 pcs.: 1 woodbox with plastic insert + 1 stainless tray Ø 38 cm + 1 cooler  
set de 3: 1 caja madera + 1 bandeja inox Ø 38 cm + 1 acumulador de frío  
set de 3: 1 base bois + 1 plateau inox Ø 38 cm + 1 accumulateur de froid

	Ø cm	↑ cm	
11542	48	6	

**Rolltophaube / rolltop cover / campana abatible / cloche basculante**

	Ø cm	↑ cm	
18388	38	20	mit verchromtem Kugelgriff

**Rolltophaube / rolltop cover / campana abatible / cloche basculante**

	Ø cm	↑ cm	
18387	38	20	mit vergoldetem Kugelgriff

**Kühllakku / cooler / acumulador de frío / accumulateur de froid**

	cm	↑ cm	
10791	25 x 19	2,5	



18388

18388

11543

**Buche, wasserfest lackiert**  
beech wood lacquered

10791

**Kühl-Akkus halten Ihre Speisen bis zu 6 Stunden kühl**  
cooling system keeps the food cool for up to 6 hours

**Buffetvitrine „DOPPELDECKER“**  
double refrigerated buffet display  
expositor de buffet redondo doble  
présentoir buffet froid, double



**11-teilig: 2 Rahmen Buchen-Holz versiegelt + 2 Edelstahl-Tablets Ø 38 cm + 2 Kühllakku + 2 Kunststoffschalen + 3 Stangen, ohne Hauben**  
11 pcs.: 2 beech wood boxes waterproof + 2 stainless trays Ø 38 cm + 2 cooler + 2 plastic deep trays + 3 fittings, without covers  
set de 11: 2 bases madera + 2 bandejas inox aprox. 38cm + 2 acumuladores + 2 cubetas plástico + 3 varas (campanas no incl.)  
set de 11: 2 caissons bois traité (hêtre) + 2 plateaux inox approx. 38 cm + 2 accus + 2 bacs plastique + 3 barres (cloches non incluses)

	Ø cm	↑ cm	
11543	48	38	verchromte Stäbe / chrome fittings pies cromados / pieds chromés

**Rolltophaube / rolltop cover / campana abatible / cloche basculante**

	Ø cm	↑ cm	
18388	38	20	mit verchromtem Kugelgriff

**Rolltophaube / rolltop cover / campana abatible / cloche basculante**

	Ø cm	↑ cm	
18387	38	20	mit vergoldetem Kugelgriff

**Kühllakku / cooler / acumulador de frío / accumulateur de froid**

	cm	↑ cm	
10791	25 x 19	2,5	

## COOLING TRAY



### Buffetvitrine „TOP FRESH GN 1/1“

cooling buffet display  
expositor buffet frío  
présentoir buffet



5-teilig: 1 Edelstahl-Tablett GN 1/1 + 2 Kühllakku + 1 Edelstahl-Schale  
+ 1 Acrylrahmen, ohne Haube

5 pcs.: 1 stainless tray GN 1/1 + 2 cooler + 1 stainless deep tray  
+ 1 frame acrylic, without cover

set de 5: 1 bandeja inox GN 1/1 + 2 acumuladores + 1 cubeta inox  
+ 1 marco metacrilato (campana no incl.)

set de 5: 1 plateau inox GN 1/1 + 2 accus. de froid + 1 bac inox  
+ 1 cadre plexi (cloche non-incl.)

	cm	↑ cm
11510	61 x 38	8

GN Rolltophaube / GN rolltop cover / GN campana rolltop / GN cloche rolltop

	cm	↑ cm	GN
11010	53 x 32,5	19	1/1

Kühllakku / cooler / acumulador de frío / accumulateur de froid

	cm	↑ cm
10791	25 x 19	2,5



### Buffetvitrine „DOPPELDECKER GN1/1“

cooling buffet display  
expositor buffet frío  
présentoir buffet



14-teilig: 2 Edelstahl-Tablets GN 1/1 + 4 Kühllakku + 2 Edelstahl-Schale  
+ 2 Acrylrahmen + 4 verchromte Stangen, ohne Hauben

14 pcs.: 2 stainless tray GN 1/1 + 4 cooler + 2 stainless deep trays  
+ 2 frames acrylic + 4 chrome plated fittings, without covers

set de 14: 2 bandejas inox GN 1/1 + 4 acum. de frío 2 cubetas inox  
+ 2 bases metacrilato + 4 varas cromadas (sin las campanas)

set de 14: 2 plateaux inox GN 1/1 + 4 accus 2 bacs inox + 2 cadres plexi  
+ 4 barres chromées (sans les cloches)

	cm	↑ cm
11514	61 x 38	33

GN Rolltophaube / GN rolltop cover / GN campana rolltop / GN cloche rolltop

	cm	↑ cm	GN
11010	53 x 32,5	19	1/1

Kühllakku / cooler / acumulador de frío / accumulateur de froid

	cm	↑ cm
10791	25 x 19	2,5





**Kühl-Akkus halten Ihre Speisen bis zu 6 Stunden kühl**  
cooling system keeps the food cool for up to 6 hours

**Kühltablett „TOP FRESH RUND“**

cooling plate  
expositor buffet frío  
présentoir buffet



**4-teilig: 1 Edelstahl-Tablett Ø 38 cm + 2 Kühllakkus + 1 Edelstahl-Schale + 1 Acrylrahmen, ohne Haube**

4 pcs.: 1 stainless tray Ø 38 cm + 2 cooler + 1 stainless deep tray + 1 frame acrylic, without cover  
set de 4: 1 bandeja inox 38cm + 2 acum. de frío + 1 cubeta inox + 1 base metacrilato (campana no incluida)  
set de 4: 1 plateau inox 38cm + 2 accum. de froid + 1 bac inox + 1 base plexi (cloche non incl.)

	Ø cm	↑ cm
11512	43,5	5,5

**Rolltophaube / rolltop cover / campana abatible / cloche basculante**

	Ø cm	↑ cm	
18388	38	20	mit verchromtem Kugelgriff

**Kühllakku / cooler / acumulador de frío / accumulateur de froid**

	cm	↑ cm	pcs.
11101	16 x 7,5	2	4



**Kühl-Akkus halten Ihre Speisen bis zu 6 Stunden kühl**  
cooling system keeps the food cool for up to 6 hours

**Buffetvitrine „DOPPELDECKER“**

cooling plate  
expositor de buffet doble redondo  
présentoir buffet



**13-teilig: 2 Edelstahl-Tablets Ø 38 cm + 4 Kühllakkus + 2 Edelstahl-Schalen + 2 Acrylrahmen + 3 verchromte Stangen, ohne Hauben**

13 pcs.: 2 stainless trays Ø 38 cm + 4 cooler + 2 stainless deep tray + 2 frames acrylic + 3 chrome plated fittings, without covers  
set de 13: 2 bandejas inox 38 cm + 4 acumuladores de frío + 3 varas cromadas + 2 bases + 2 bandejas, campana no incluida  
set de 13: 2 plateaux inox 38cm + 4 accum. de froid + 2 bacs inox + 2 bases plexi + 3 barres chromées (cloche non incl.)

	Ø cm	↑ cm
11516	43,5	33

**Rolltophaube / rolltop cover / campana abatible / cloche basculante**

	Ø cm	↑ cm	
18388	38	20	mit verchromtem Kugelgriff

**Kühllakku / cooler / acumulador de frío / accumulateur de froid**

	cm	↑ cm	pcs.
11101	16 x 7,5	2	4

## COOLING DISPLAY



### Kühlbox „TOP FRESH GN 1/1“

cooling plate  
bandeja de frío  
présentoir buffet réfrigéré



4-teilig: 1 Kühlbox + 1 Tablett GN 1/1 + 2 Kühlakkus, ohne Haube

4 pcs.: 1 box + 1 tray GN 1/1 + 2 coolers, without cover

set de 4: 1 caja plástico blanco + 1 bandeja GN 1/1 + 2 acum. de frío, campana no incluida

set de 4: 1 caisson plastique blanc + 1 plateau GN 1/1 + 2 accum. de froid, cloche non incl.

	cm	↑ cm	Farbe / Colour
11503	56,5 x 35	6,5	White
11505	56,5 x 35	6,5	Black

GN Rolltophaube / GN rolltop cover / GN campana rolltop / GN cloche rolltop

	cm	↑ cm	GN
11008	53,0 x 32,5	19	1/1 mit vergoldetem Kreuzgriff

GN Rolltophaube / GN rolltop cover / GN campana rolltop / GN cloche rolltop

	cm	↑ cm	GN
11010	53 x 32,5	19	1/1 mit verchromtem Kreuzgriff

Kühlakku / cooler / acumulador de frío / accumulateur de froid

	cm	↑ cm
10791	25 x 19	2,5

GN Edelstahl-Tablett „PROFI LINE“ / GN tray / GN bandeja / GN plat empilable système catering

	cm	↑ cm	GN
11100	53 x 32,5	1,5	1/1



### Kühlbox „TOP FRESH GN 1/1“

cooling box  
expositor buffet frío  
présentoir buffet



4-teilig: 1 Kühlbox + Tablett GN 1/1 + 2 Kühlakkus, ohne Haube

4 pcs.: 1 box + 1 tray GN 1/1 + 2 cooler, without rolltop cover

set de 4: 1 cajón + 1 bandeja GN 1/1 + 2 enfriadores, campana no incluida

set de 4: 1 caisson inférieur + 1 plateau GN 1/1 + 2 accus, cloche non incluse

	cm	↑ cm
11590	56,5 x 36	8,5

GN Rolltophaube / GN rolltop cover / GN campana rolltop / GN cloche rolltop

	cm	↑ cm	GN
11008	53 x 32,5	19	1/1

GN Rolltophaube / GN rolltop cover / GN campana rolltop / GN cloche rolltop

	cm	↑ cm	GN
11010	53 x 32,5	19	1/1

Kühlakku / cooler / acumulador de frío / accumulateur de froid

	cm	↑ cm
10791	25 x 19	2,5



18388

11538

10791

**Kühl-Akkus halten Ihre Speisen bis zu 6 Stunden kühl**  
cooling system keeps the food cool for up to 6 hours

**Kühlbox „TOP FRESH SET“**

cooling plate  
bandeja de frío  
set réfrigère



**3-teilig: 1 Box + 1 Tablett Ø 38 cm + 1 Kühllakku, ohne Haube**

3 pcs.: 1 box + 1 tray Ø 38 cm + 1 cooler, without cover

set de 3: 1 caja + 1 bandeja Ø 38 cm + 1 enfriador, sin tapa

set de 3: 1 caisson + 1 plateau Ø 38 cm + 1 accum. (livré sans la cloche)

	Ø cm	↑ cm	Farbe / Colour
11538	42	6	
11533	42	6	

**Rolltophaube / rolltop cover / campana abatible / cloche basculante**

	Ø cm	↑ cm	
18388	38	20	mit verchromtem Kugelgriff

**Kühllakku / cooler / acumulador de frío / accumulateur de froid**

	cm	↑ cm	
10791	25 x 19	2,5	



18388

09082

11101

**Kühl-Akkus halten Ihre Speisen bis zu 6 Stunden kühl**  
cooling system keeps the food cool for up to 6 hours

**Thermo-Set**

thermo set  
bandeja isotérmica  
set thermo



**5-teilig: 1 Tablett tief + 1 Tablett flach + 2 Kühllakkus + 1 Rolltophaube**

5 pcs.: 1 deep tray + 1 tray + 2 cooler + 1 rolltop cover

set de 5: 1 bandeja inferior + 1 bandeja + 2 acumuladores frío + campana

set de 5: 1 plateau creux + 1 plateau plat + 2 accum. + 1 cloche rolltop

	Ø cm	↑ cm	
09082	38	24	

**Rolltophaube / rolltop cover / campana abatible / cloche basculante**

	Ø cm	↑ cm	
18388	38	20	mit verchromtem Kugelgriff

**Kühllakku / cooler / acumulador de frío / accumulateur de froid**

	cm	↑ cm	pcs.
11101	16 x 7,5	2	4



09083

11101

**Kühl-Akkus halten Ihre Speisen bis zu 6 Stunden kühl**  
cooling system keeps the food cool for up to 6 hours

**Thermo-Set**

thermo set  
porta tartas refrigerado  
porte-gâteau réfrigéré



**4-teilig: 1 Tablett tief auf Fuß + 1 Tablett flach + 2 Kühllakkus**

4 pcs.: 1 deep tray with feet + 1 tray + 2 cooler

set de 4: 1 bandeja honda con pie + 1 bandeja + 2 acumuladores de frío

set de 4: 1 plateau creux avec pied + 1 plateau plat + 2 accum.

	Ø cm	↑ cm	
09083	38	14,5	

**Rolltophaube / rolltop cover / campana abatible / cloche basculante**

	Ø cm	↑ cm	
18388	38	20	mit verchromtem Kugelgriff

**Kühllakku / cooler / acumulador de frío / accumulateur de froid**

	cm	↑ cm	pcs.
11101	16 x 7,5	2	4



## COOLING DISPLAY



### Kühlschale Mini Holz „TOP FRESH“

cool bowl mini holz  
bol refrigerado mini madera  
bol réfrigéré MINI bois



4-teilig: 1 Fuß Buchen-Holz versiegelt + 1 Schale + 1 Kühlakku  
+ 1 klappbarer Deckel mit Beschriftungsschild

4 pcs.: 1 column with food base (beech) + 1 bowl  
+ 1 cooler + 1 cover with card, hinged

set de 4: 1 bol policarbonato + 1 base madera  
+ 1 acum. de frío + 1 tapa con bisagra y porta etiqueta

set de 4 : 1 base en bois + 1 accum + 1 bol polycarbonate  
+ 1 couvercle à charnière avec porte-étiquette

	Ø cm	↑ cm	ltr.
11812	14	9,0	0,6
11813	14	11,5	1,0

Ersatzschale / spare bowl / recambio bol / bol de rechange

	Ø cm	↑ cm
11811	14	6,5
11816	14	9,0

Schutzdeckel mit Löffelaussparung / cover / tapa / couvercle

	Ø cm
11868	14,5

Kühlakku / cooler / acumulador de frío / accumulateur de froid

	Ø cm	↑ cm
10661	10,5	2



### Kühlschale Maxi Holz „TOP FRESH“

cool bowl maxi holz  
bol refrigerado MAXI madera  
bol réfrigéré MAXI bois



4-teilig: 1 Fuß Buchen-Holz versiegelt + 1 Schale + 1 Kühlakku  
+ 1 klappbarer Deckel mit Beschriftungsschild

4 pcs.: 1 column with food base (beech) + 1 bowl  
+ 1 cooler + 1 cover with card, hinged

set de 4: 1 bol + 1 base madera + 1 acumulador de frío  
+ 1 tapa con bisagra y porta etiqueta

set de 4: 1 base en bois + 1 accum. + 1 bol  
+ 1 couvercle à charnière avec porte-étiquette

	Ø cm	↑ cm	ltr.
11817	22	14	2,5
11818	22	18	4,0

Ersatzschale / spare bowl / recambio bol / bol de rechange

	Ø cm	↑ cm
11846	22	8
11848	22	12

Schutzdeckel mit Löffelaussparung / cover / tapa / couvercle

	Ø cm
11878	23,5

Kühlakku / cooler / acumulador de frío / accumulateur de froid

	Ø cm	↑ cm
10777	15	2,5



**Kühlschale Mini „TOP FRESH“**

cool bowl mini  
bol refrigerado MINI  
bol réfrigéré MINI



4-teilig: 1 Edelstahlgefäß matt + 1 Kühlakku + 1 Schale + 1 klappbarer Deckel mit Beschriftungsschild

4 pcs.: 1 column satin polished finish + 1 cooler + 1 bowl + 1 cover with card, hinged

set de 4: 1 base acabado efecto satinado + 1 acumulador de frío + 1 tapa con porta etiqueta + 1 bol

set de 4: 1 base inox mat satiné + 1 accum. de froid + 1 couvercle à charnière avec porte étiquette + 1 bol

	Ø cm	↑ cm	ltr.
11810	14	9,0	0,6
11815	14	11,5	1,0

**Ersatzschale / spare bowl / recambio bol / bol de rechange**

	Ø cm	↑ cm
11811	14	6,5
11816	14	9,0

**Schutzdeckel mit Löffelaussparung / cover / tapa / couvercle**

	Ø cm
11868	14,5

**Kühlakku / cooler / acumulador de frío / accumulateur de froid**

	Ø cm	↑ cm
10661	10,5	2



**Kühlschale Maxi „TOP FRESH“**

cool bowl maxi  
bol refrigerado MAXI  
bol réfrigéré MAXI



4-teilig: 1 Gefäß hochglanzpoliert + 1 Kühlakku + 1 Schale + 1 klappbarer Deckel mit Beschriftungsschild

4 pcs.: 1 column mirror polished finish + 1 cooler + 1 bowl + 1 cover with card, hinged

set de 4: 1 base pulido acabado efecto espejo + 1 acumulador de frío + 1 tapa con porta etiqueta + 1 bol

set de 4: 1 base inox poli brillant + 1 accum. + 1 récipient + 1 couvercle à charnière avec porte-étiquette

	Ø cm	↑ cm	ltr.
11847	22	14	2,5
11849	22	18	4,0

**Ersatzschale / spare bowl / recambio bol / bol de rechange**

	Ø cm	↑ cm
11846	22	8
11848	22	12

**Schutzdeckel mit Löffelaussparung / cover / tapa / couvercle**

	Ø cm
11878	23,5

**Kühlakku / cooler / acumulador de frío / accumulateur de froid**

	Ø cm	↑ cm
10777	15	2,5

## COOLING DISPLAY



11845  
2,5 ltr.

11875

### Kühlschale Maxi „TOP FRESH“

cool bowl maxi  
cuenco refrigerado MAXI  
bol réfrigéré MAXI



4-teilig: 1 Gefäß hochglanzpoliert + 1 Kühlakku + 1 Glasschale  
+ 1 klappbarer Deckel mit Beschriftungsschild

4 pcs.: 1 column mirror polished finish + 1 cooler  
+ 1 glass bowl + 1 cover with card, hinged

set de 4: 1 base pulido acabado efecto espejo  
+ 1 acumulador de frío + 1 tapa con porta etiqueta + 1 bol vidrio

set de 4 : 1 base inox poli brillante + 1 accum.  
+ 1 bol verre + 1 couvercle à charnière avec porte-étiquette

	Ø cm	↑ cm	ltr.
11845	23	14	2,5

### Schale / bowl / cuenco / bol

	Ø cm	↑ cm	ltr.
11875	23	10,5	2,5

### Schutzdeckel mit Löffelaussparung / cover / tapa / couvercle

	Ø cm
11878	23,5

### Kühlakku / cooler / acumulador de frío / accumulateur de froid

	Ø cm	↑ cm
10777	15	2,5



83696

83705

83920

### Schale „CASUAL MAXI“

bowl  
cuenco  
bol



	Ø cm	↑ cm	ltr.	Farbe / Colour
83696	10	4,5	0,15	White
83698	12	5,5	0,25	White
83700	14	6,5	0,50	White
83704	20	9,2	1,80	White
83702	23	10,5	2,50	White

	Ø cm	↑ cm	ltr.	Farbe / Colour
83697	10	4,5	0,15	Black
83699	12	5,5	0,25	Black
83701	14	6,5	0,50	Black
83705	20	9,2	1,80	Black
83703	23	10,5	2,50	Black

Deckel „FLOAT“ mit Löffelaussparung / cover, with notched for spoons / tapa, con espacio para la cuchara / couvercle, avec encoche pour la louche

	Ø cm	↑ cm	fits to
83920	20,5	1,3	83704, 83705





**Buffet-Set „FOCUS“**

buffet set  
set de buffet  
présentoir pour le buffet

4-teilig: Box, Tablett, 2 Kühlakkus

4 pcs.: box, tray, 2 cooler  
set de 4.: box, bandeja, 2 enfriadores  
swt de 4: caisson, 2 plateau, bac



	cm	↑ cm	Farbe / Colour
09000	43,5 x 32,5	6	White
09001	43,5 x 32,5	6	Black

**Edelstahltablett / tray / bandeja / plateau**

	cm	↑ cm
09010	43,5 x 32,5	1,5

**Holzschneidebrett / wooden board / tablero de madera / planche à découper**

	cm	↑ cm
09016	43,5 x 32,5	2

**Basisteil / base / base / base**

	cm	↑ cm	Farbe / Colour
09011	42,5 x 31,5	6	White
09012	42,5 x 31,5	6	Black

**Rolltophaube „FOCUS“ / rolltop cover / campana abatible / cloche basculante**

	cm	↑ cm
09013	44 x 33,5	17

**Kühlakku / cooler / acumulador de frío / accumulateur de froid**

	cm	↑ cm
10791	25 x 19	2,5

**Kühl-Akkus halten Ihre Speisen bis zu 6 Stunden kühl**  
cooling system keeps the food cool for up to 6 hours



**Buffet-Set „FOCUS“**

buffet set  
set de buffet  
présentoir pour le buffet

3-teilig: Box, Tablett, 1 Kühlakku

3 pcs.: box, tray, 1 cooler  
set de 3.: box, bandeja, 1 enfriador  
set de 3: caisson, 1 plateau, bac



	Ø cm	↑ cm	Farbe / Colour
09002	38	6	White
09003	38	6	Black

**Edelstahltablett / tray / bandeja / plateau**

	Ø cm	↑ cm
09020	38	1,5

**Basisteil / base / base / base**

	Ø cm	↑ cm	Farbe / Colour
09021	37	6	White
09022	37	6	Black

**Rolltophaube / rolltop cover / campana abatible / cloche basculante**

	Ø cm	↑ cm
09023	38	20

**Kühl-Akkus halten Ihre Speisen bis zu 6 Stunden kühl**  
cooling system keeps the food cool for up to 6 hours

## COOLING DISPLAY

09100

09102

90902

11101

**Kühl-Akkus halten Ihre Speisen bis zu 6 Stunden kühl**  
cooling system keeps the food cool for up to 6 hours

### Buffetvitrine

showcase  
vitrina de buffet  
vitrine de buffet



1 transparente Rolltopphaube beidseitig aufklappbar + 1 Schale (ABS)  
+ 1 Edelstahl-Tablett 39 x 28 cm + 2 Kühl-Akkus

1 transparent rolltop cover + 1 tray (ABS) + 1 stainless tray 39 x 28 cm + 2 coolers, demountable  
1 tapa abatible transparente + 1 bandeja (ABS) + 1 bandeja 39x28cm + 2 enfriadores, desmontable

1 cloche transparente ouverture 2 côtés + 1 caisson (ABS) + 1 plateau inox 39 x 28 cm +  
2 accumulateurs de froid, démontable

	cm	↑ cm	Farbe / Colour
09100	44 x 32	20,5	White
09102	44 x 32	20,5	Blue
09104	44 x 32	20,5	Black

Kühlakku / cooler / acumulador de frío / accumulateur de froid

	cm	↑ cm	pcs.
11101	16 x 7,5	2	4

Edelstahl-Tablett / stainless steel tray / bandeja de acero inoxidable / plateau inox

	cm
90902	39 x 28



Servierbeispiel  
presentation example

11101

**Kühl-Akkus halten Ihre Speisen bis zu 6 Stunden kühl**  
cooling system keeps the food cool for up to 6 hours

### Thermo Tablett-Set

thermo tray  
bandeja termo  
caisson thermo



1 stabile Schale + 1 Edelstahl-Tablett + 2 Kühlakkus + 1 Frischhaltehaube

1 plastic tray + 1 stainless tray + 2 coolers + 1 cover

1 bandeja de plástico + 1 bandeja inox + 2 acumuladores + 1 campana

1 plateau plastique + 1 plateau inox + 2 accumulateurs de froid + 1 cloche

	cm	↑ cm
09090	43 x 29	14

Kühlakku / cooler / acumulador de frío / accumulateur de froid

	cm	↑ cm	pcs.
11101	16 x 7,5	2	4

Haube / cover / campana / cloche

	cm	↑ cm
90901	43 x 29	14

Edelstahl-Tablett / stainless steel tray / bandeja de acero inoxidable / plateau inox

	cm
90902	39 x 28



**Buffetvitrine „DOPPELDECKER“**

showcase  
vitrina de buffet, 2 alturas  
vitrine de buffet double



2 transparente Rolltophauben beidseitig aufklappbar + 2 Schalen (ABS) + 2 Edelstahl-Tabletts 39 x 28 cm + 4 Kühl-Akkus, platzsparend lagerbar  
2 transparent rolltop cover + 2 trays (ABS) + 2 tray 39 x 28 cm + 4 coolers, demountable, space saving  
2 campanas abatibles por ambos lados + 2 bandejas (ABS) + 2 bandejas 39 x 28 cm + 4 acumuladores, desmontable, ahorra espacio  
2 cloches transparentes abattantes 2 côtés + 2 caissons (ABS) + 2 plateaux 39 x 28 cm + 4 accumulateurs de froid, gain d'espace

	cm	↑ cm	Farbe / Colour
09200	44 x 32	44	White
09202	44 x 32	44	Blue
09204	44 x 32	44	Black

**Kühlakku / cooler / acumulador de frío / accumulateur de froid**

	cm	↑ cm	pcs.
11101	16 x 7,5	2	4

**Edelstahl-Tablett / stainless steel tray / bandeja de acero inoxidable / plateau inox**

	cm
90902	39 x 28



**Thermo Tablett-Set**

thermo tray  
bandeja termo  
caisson thermo



1 stabile Schale + 1 Edelstahl-Tablett + 2 Kühlakkus + 1 Frischhaltehaube  
1 plastic tray + 1 stainless tray + 2 coolers + 1 cover  
1 bandeja de plástico + 1 bandeja inox + 2 acumuladores + 1 campana  
1 plateau plastique + 1 plateau inox + 2 accumulateurs de froid + 1 cloche

	Ø cm	↑ cm
09093	35	15

**Kühlakku / cooler / acumulador de frío / accumulateur de froid**

	cm	↑ cm	pcs.
11101	16 x 7,5	2	4

**Kühl-Akkus halten Ihre Speisen bis zu 6 Stunden kühl**  
cooling system keeps the food cool for up to 6 hours



## COOLING DISPLAY



### Thermo Tablett-Set, 6-teilig

thermo tray, 6 pcs.  
bandeja térmica, set de 6  
plateau thermique, set de 6



#### 6 teiliges Set:

- 1 Schale
- 1 Edelstahltablett
- 2 Kühllakkus
- 1 transparente Frischhaltehaube
- 1 Transport- und Tragegurt aus Silikon

#### 6 pcs.:

- 1 plastic tray
- 1 stainless steel tray
- 2 coolers
- 1 transparent cover
- 1 silicone transport and carrying strap

#### set de 6:

- 1 bandeja de plástico
- 1 bandeja de acero inoxidable
- 2 acumuladores de frío
- 1 campana transparente
- 1 correa de silicona para cierre y transporte

#### set de 6:

- 1 plateau plastique
- 1 plateau en acier inox
- 2 accumulateurs de froid
- 1 cloche transparente
- 1 sangle en silicone pour fermeture et transport

**NEU**  
inkl.  
Transport- und  
Tragegurt!

	cm	↑ cm	Farbe / Colour
09091	43 x 29	14	
09090	43 x 29	14	



inkl. 2x Kühl-Akkus  
incl. 2x cooler keeps



### Thermo Tablett-Set, 6-teilig

thermo tray, 6 pcs.  
bandeja térmica, set de 6  
plateau thermique, set de 6



#### 6 teiliges Set:

- 1 Schale
- 1 Edelstahl-Tablett
- 2 Kühllakkus
- 1 Frischhaltehaube
- 1 Transport- und Tragegurt aus Silikon

#### 6 pcs.:

- 1 plastic tray
- 1 stainless tray
- 2 coolers + 1 cover
- 1 silicone transport and carrying strap

#### set de 6:

- 1 bandeja de plástico
- 1 bandeja de acero inoxidable
- 2 acumuladores de frío
- 1 campana
- 1 correa de silicona para cierre y transporte

#### set de 6:

- 1 plateau plastique
- 1 plateau en acier inox
- 2 accumulateurs de froid
- 1 cloche transparente
- 1 sangle en silicone pour fermeture et transport

**NEU**  
inkl.  
Transport- und  
Tragegurt!

	cm	↑ cm	Farbe / Colour
09094	35	15	
09093	35	15	



inkl. 2x Kühl-Akkus  
incl. 2x cooler keeps

# BEVERAGE DISPENSER



7 ltr.

## Getränkespender „OLD FASHIONED“

beverage dispenser  
dispensador de bebidas  
distributeur de boissons



dicke, stabile Wände, weite Öffnung für große Zutaten, Gestell schwarz  
thick, stable walls, a wide opening for large ingredients, black stand  
tiene paredes gruesas y estables, amplia abertura para ingredientes grandes, soporte negro  
des murs épais et stables, large ouverture pour de grands ingrédients, support noir

	Ø cm	↑ cm	ltr.	
10409	27	50,5	7	inkl. Gestell / incl. stand

Ersatz-Gestell zu Getränkenspender / stand for beverage dispenser / soporte de recambio para el dispensador de bebidas / support de remplacement pour le distributeur de boissons

	Ø cm	↑ cm	
10410	27	31,5	

Ersatz-Glas zu Getränkenspender ohne Zapfhahn / replacement glass for beverage dispenser without tap / cristal de recambio para el dispensador de bebidas sin grifo / vitre de rechange pour le distributeur de boissons sans robinet

	Ø cm	↑ cm	ltr.
10411	19	36,5	7

Ersatz-Zapfhahn zu Getränkenspender / replacement tap for beverage dispenser

10718



7 ltr.

## Getränkespender „ASIA“

beverage dispenser  
dispensador de bebidas  
distributeur de boissons



dicke, stabile Wände, weite Öffnung für große Zutaten, Fuß und Deckel aus Holz  
thick, stable walls, a wide opening for large ingredients, wooden stand and lid  
tiene paredes gruesas y estables, amplia abertura para ingredientes grandes, soporte y tapa de madera  
des murs épais et stables, large ouverture pour de grands ingrédients, support et couvercle en bois

	Ø cm	↑ cm	ltr.	
10403	24,5	45,5	7	inkl. Gestell / incl. stand

Ersatz-Fuß zu Getränkenspender mit Anti-Rutsch-Füßchen / base to beverage dispenser with non slip feet / soporte de recambio para el dispensador de bebidas con pies antideslizantes / support de remplacement pour le distributeur de boissons avec pieds antidérapants

	Ø cm	↑ cm	
10404	24,5	15	

Ersatz-Deckel zu Getränkenspender / replacement lid for beverage dispenser / tapa de recambio para el dispensador de bebidas / couvercle de rechange pour le distributeur de boissons

	Ø cm	↑ cm	
10405	14,0	5	

# BEVERAGE DISPENSER



## Getränkespender „ELEMENT“

beverage dispenser  
dispensador de bebidas  
distributeur de boissons



**dicke, stabile Wände, weite Öffnung für große Zutaten, Fuß und Deckel aus Beton**  
thick, stable walls, a wide opening for large ingredients, stand and lid made of concrete  
tiene paredes gruesas y estables, amplia abertura para ingredientes grandes, soporte y tapa de hormigón  
des murs épais et stables, large ouverture pour de grands ingrédients, support et couvercle en béton

	Ø cm	↑ cm	ltr.	
10400	22	45	7	inkl. Gestell / incl. stand



## Getränkespender

beverage dispenser  
dispensador de bebidas  
distributeur de boissons



**dicke, stabile Wände, weite Öffnung für große Zutaten**  
thick, stable walls, a wide opening for large ingredients  
tiene paredes gruesas y estables, amplia abertura para ingredientes grandes  
des murs épais et stables, large ouverture pour de grands ingrédients

	Ø cm	↑ cm	ltr.
10855	20	30,5	7



## Tropfenschale, 2-teilig

drip tray, 2 pcs.  
aros anti-goteo, set de 2  
anneaux coupe-gouttes, set de 2



	Ø cm	↑ cm	Farbe / Colour
10851	9,5	1,5	White
10853	9,5	1,5	Black



## Eiswasserröhre

ice cube cooling tube  
tubo enfriador para cubitos  
tube pour glaçons



	Ø cm	↑ cm	passend für Getränkenspender / fits to drink dispenser
10849	11	24	10400, 10403, 10855



Präsentationsmöglichkeit  
presentation example



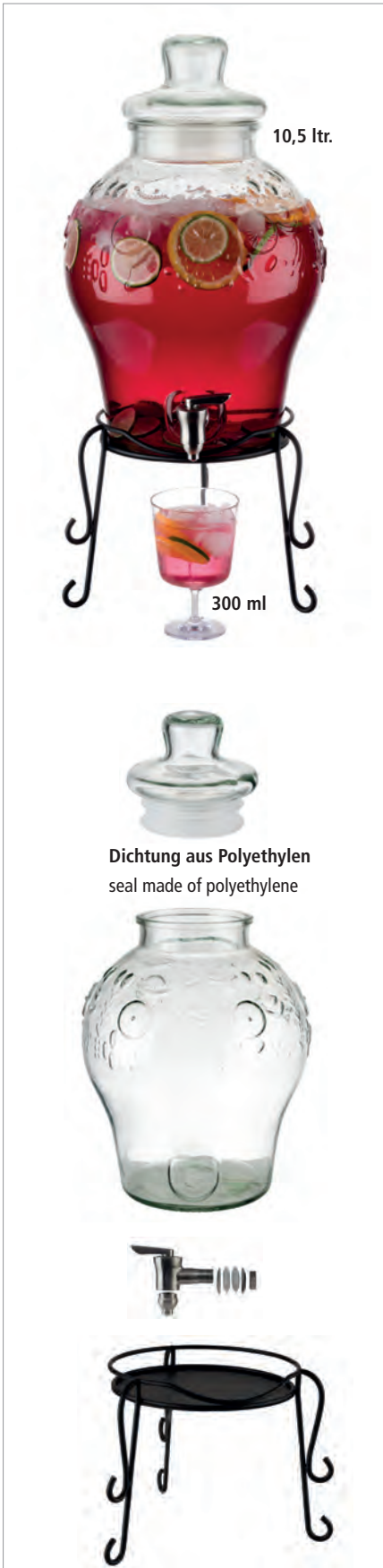

10,5 ltr.

300 ml

Dichtung aus Polyethylen  
seal made of polyethylen

**Getränkespender „FRUITS“**

beverage dispenser  
dispensador de bebidas  
distributeur de boissons



dicke, stabile Wände, weite Öffnung für große Zutaten, Gestell schwarz  
thick, stable walls, a wide opening for large ingredients, black stand  
tiene paredes gruesas y estables, amplia abertura para ingredientes grandes, soporte negro  
des murs épais et stables, large ouverture pour de grands ingrédients, support noir

	Ø cm	↑ cm	ltr.	
10415	25	58	10,5	inkl. Gestell / incl. stand

**Trinkglas „BEACH“**

drinking glass / vaso / verre



	Ø cm	↑ cm	ltr.	VE
10505	8,5	13,5	0,3	48

**Ersatzteile Getränkspender „FRUITS“**

spare parts beverage dispenser  
recambios dispensador de bebidas  
pièces distributeur de boissons

Ersatz-Deckel zu Getränkspender „FRUITS“  
replacement glass for beverage dispenser / cristal de recambio  
para el dispensador de bebidas / vitre de rechange pour le  
distributeur de boissons



	Ø cm	↑ cm
10418	14	12

**Ersatz-Glas zu Getränkspender „FRUITS“ inkl. Deckel, ohne Zapfhahn**

replacement glass for beverage dispenser without tap  
cristal de recambio para el dispensador de bebidas sin grifo  
vitre de rechange pour le distributeur de boissons sans robinet

	Ø cm	↑ cm	ltr.
10417	25	42	10,5

Ersatz-Zapfhahn zu Getränkspender  
replacement tap for beverage dispenser  
grifo de recambio para el dispensador de bebidas  
robinet de rechange pour le distributeur de boissons



10718
-------

Ersatz-Gestell zu Getränkspender  
stand for beverage dispenser  
soporte de recambio para el dispensador de bebidas  
support de remplacement pour le distributeur de boissons



	Ø cm	↑ cm
10416	26	19

**Trinkglas „OLD FASHIONED“**

drinking cup  
vaso  
gobelet



	Ø cm	↑ cm	ltr.	VE
10520	8	12,5	0,3	6

# BEVERAGE DISPENSER



4,5 ltr.

300 ml

Glas inkl. Zapfhahn

## Getränkespender „FRESH WHITE“

beverage dispenser  
dispensador de bebidas  
distributeur de boissons

Behälter mit Edelstahlzapfhahn und Holzdeckel, stabiles Glas,  
inkl. weißem Holzstandfuß und Kork-Untersetzer

container with stainless steel tap and wooden cover, solid glass,  
incl. white wooden base and cork coaster

recipiente con grifo de acero inoxidable y tapa de madera, cristal sólido,  
incl. pie de madera blanca y posavasos de corcho

réceptif avec robinet en acier inox et couvercle en bois, verre robuste,  
incl. pied en bois blanc et soucoupes de liège

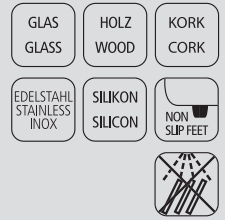

	cm	↑ cm	ltr.	
10420	23 x 23	56,5	4,5	inkl. Gestell / incl. stand

Trinkbecher „CRYSTAL“  
drinking cup / vaso / gobelet



	Ø cm	↑ cm	ltr.	VE
10501	8	12,5	0,3	48

## Ersatzteile Getränkspender „FRESH WHITE“

spare parts beverage dispenser  
recambios dispensador de bebidas  
pièces distributeur de boissons

Ersatz-Deckel zu Getränkspender „FRESH WHITE“

replacement lid for beverage dispenser  
tapa de recambio para el dispensador de bebidas  
couvercle de rechange pour le distributeur de boissons



	Ø cm	↑ cm	Farbe / Colour
10423	11,5	1,5	_____

Ersatz-Glas zu Getränkspender „FRESH WHITE“, inkl. Zapfhahn

replacement glass for beverage dispenser with tap  
cristal de recambio para el dispensador de bebidas con grifo  
vitre de rechange pour le distributeur de boissons avec robinet



	Ø cm	↑ cm	ltr.
10422	15,5	42,0	4,5

Ersatz-Untersetzer aus Kork zu Getränkspender „FRESH WHITE“

replacement cork coaster for beverage dispenser  
posavasos de corcho de recambio para el dispensador de bebidas  
soucoupes de liège de rechange pour le distributeur de boissons



	Ø cm	↑ cm
10424	16,5	1,5

Ersatz-Gestell zu Getränkspender „FRESH WHITE“

stand for beverage dispenser  
soporte de recambio para el dispensador de bebidas  
support de remplacement pour le distributeur de boissons



	cm	↑ cm	Farbe / Colour
10421	23 x 23	14	_____



4,5 ltr.

**Getränkespender „FRESH WOOD“**

beverage dispenser  
dispensador de bebidas  
distributeur de boissons

Behälter mit Edelstahlzapfhahn und Korkdeckel, stabiles Glas,  
inkl. Holzstandfuß und Kork-Untersetzer

container with stainless steel tap and cork cover, solid glas,  
incl. wooden base and cork coaster

recipiente con grifo de acero inoxidable y tapa de corcho, cristal sólido,  
incl. pie de madera y posavasos de corcho

réceptif avec robinet en acier inox et couvercle de liège, verre robuste,  
incl. pied en bois et soucoupes de liège

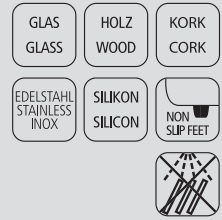

	cm	↑ cm	ltr.	
10430	23 x 23	56,5	4,5	inkl. Gestell / incl. stand



4,5 ltr.

Glas inkl. Zapfhahn

**Trinkbecher „CRYSTAL“**  
drinking cup / vaso / gobelet



	Ø cm	↑ cm	ltr.	VE
10501	8	12,5	0,3	48

**Tropfenschale**  
drip tray  
aro anti-goteo  
anneau coupe-gouttes



	Ø cm	↑ cm	Farbe / Colour
10851	9,5	1,5	

**Ersatzteile Getränkespender „FRESH WOOD“**

spare parts beverage dispenser  
recambios dispensador de bebidas  
pièces distributeur de boissons

**Ersatz-Deckel zu Getränkespender „FRESH WOOD“**  
replacement lid for beverage dispenser  
tapa de recambio para el dispensador de bebidas  
couvercle de rechange pour le distributeur de boissons



	Ø cm	↑ cm	Farbe / Colour
10428	11,5	1,5	

**Ersatz-Glas zu Getränkespender „FRESH WOOD“, inkl. Zapfhahn**  
replacement glass for beverage dispenser with tap  
cristal de recambio para el dispensador de bebidas con grifo  
vitre de rechange pour le distributeur de boissons avec robinet



	Ø cm	↑ cm	ltr.
10422	15,5	42,0	4,5

**Ersatz-Untersetzer aus Kork zu Getränkespender „FRESH WOOD“**  
replacement cork coaster for beverage dispenser  
posavasos de corcho de recambio para el dispensador de bebidas  
soucoupes de liège de rechange pour le distributeur de boissons



	Ø cm	↑ cm
10424	16,5	1,5

**Ersatz-Gestell zu Getränkespender „FRESH WOOD“**  
stand for beverage dispenser  
soporte de recambio para el dispensador de bebidas  
support de remplacement pour le distributeur de boissons



	cm	↑ cm	Farbe / Colour
10426	23 x 23	14	





# BEVERAGE DISPENSER



7,5 ltr.

300 ml

7,5 ltr.

Glas inkl. Zapfhahn

## Getränkespender „NORDIC WHITE“

beverage dispenser  
dispensador de bebidas  
distributeur de boissons

Behälter mit Edelstahlzapfhahn und Holzdeckel, stabiles Glas,  
inkl. weißem Holzstandfuß und Kork-Untersetter

container with stainless steel tap and wooden cover, solid glass,  
incl. white wooden base and cork coaster

recipiente con grifo de acero inoxidable y tapa de madera, cristal sólido,  
incl. pie de madera blanca y posavasos de corcho

réceptif avec robinet en acier inox et couvercle en bois, verre robuste,  
incl. pied en bois blanc et soucoupes de liège

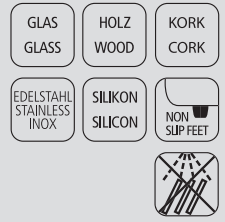

	cm	↑ cm	ltr.	
10425	23 x 23	60,5	7,5	inkl. Gestell / incl. stand

## Trinkbecher „CRYSTAL“

drinking cup / vaso / gobelet



	Ø cm	↑ cm	ltr.	VE
10501	8	12,5	0,3	48

## Tropfenschale

drip tray  
aro anti-goteo  
anneau coupe-gouttes



	Ø cm	↑ cm	Farbe / Colour
10851	9,5	1,5	_____

## Ersatzteile Getränkspender „NORDIC WHITE“

spare parts beverage dispenser  
recambios dispensador de bebidas  
pièces distributeur de boissons

### Ersatz-Deckel zu Getränkspender „NORDIC WHITE“

replacement lid for beverage dispenser  
tapa de recambio para el dispensador de bebidas  
couvercle de rechange pour le distributeur de boissons avec robinet



	Ø cm	↑ cm	Farbe / Colour
10423	11,5	1,5	_____

### Ersatz-Glas zu Getränkspender „NORDIC WHITE“, inkl. Zapfhahn

replacement glass for beverage dispenser with tap  
cristal de recambio para el dispensador de bebidas con grifo  
vitre de rechange pour le distributeur de boissons avec robinet



	Ø cm	↑ cm	ltr.
10427	17	46	7,5

### Ersatz-Untersetter aus Kork zu Getränkspender „NORDIC WHITE“

replacement cork coaster for beverage dispenser  
posavasos de corcho de recambio para el dispensador de bebidas  
soucoupes de liège de rechange pour le distributeur de boissons



	Ø cm	↑ cm
10424	16,5	1,5

### Ersatz-Gestell zu Getränkspender „NORDIC WHITE“

stand for beverage dispenser  
soporte de recambio para el dispensador de bebidas  
support de remplacement pour le distributeur de boissons



	cm	↑ cm	Farbe / Colour
10421	23 x 23	14	_____



7,5 ltr.

300 ml



7,5 ltr.

Glas inkl. Zapfhahn



**Getränkespender „NORDIC WOOD“**

beverage dispenser  
dispensador de bebidas  
distributeur de boissons

Behälter mit Edelstahlzapfhahn und Korkdeckel, stabiles Glas,  
inkl. Holzstandfuß und Kork-Untersetzer

container with stainless steel tap and cork cover, solid glas,  
incl. wooden base and cork coaster

recipiente con grifo de acero inoxidable y tapa de corcho, cristal sólido,  
incl. pie de madera y posavasos de corcho

réceptier avec robinet en acier inox et couvercle de liège, verre robuste,  
incl. pied en bois et soucoupes de liège

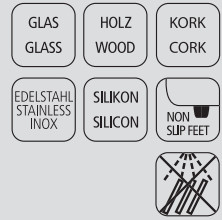

	cm	↑ cm	ltr.	
10435	23 x 23	60,5	7,5	inkl. Gestell / incl. stand

**Trinkbecher „CRYSTAL“**  
drinking cup / vaso / gobelet



	Ø cm	↑ cm	ltr.	VE
10501	8	12,5	0,3	48

**Ersatzteile Getränkespender „NORDIC WOOD“**

parts beverage dispenser  
recambios dispensador de bebidas  
pièces distributeur de boissons

**Ersatz-Deckel zu Getränkespender**  
replacement lid for beverage dispenser  
tapa de recambio para el dispensador de bebidas  
couvercle de rechange pour le distributeur de boissons



	Ø cm	↑ cm
10428	11,5	1,5

**Ersatz-Glas zu Getränkespender „NORDIC WOOD“, inkl. Zapfhahn**  
replacement glass for beverage dispenser with tap  
cristal de recambio para el dispensador de bebidas con grifo  
vitre de rechange pour le distributeur de boissons avec robinet



	Ø cm	↑ cm	ltr.
10427	17	46	7,5

**Ersatz-Untersetzer aus Kork zu Getränkespender „NORDIC WOOD“**  
replacement cork coaster for beverage dispenser  
posavasos de corcho de recambio para el dispensador de bebidas  
soucoupes de liège de rechange pour le distributeur de boissons



	Ø cm	↑ cm
10424	16,5	1,5

**Ersatz-Gestell zu Getränkespender „NORDIC WOOD“**  
stand for beverage dispenser  
soporte de recambio para el dispensador de bebidas  
support de remplacement pour le distributeur de boissons



	cm	↑ cm	Farbe / Colour
10426	23 x 23	14	

## BEVERAGE DISPENSER



### Saftdispenser „TOP FRESH“

juice dispenser  
dispensador de zumo  
distributeur à jus de fruit



hochglanzpoliert, Kühlung durch 2 Kühllakkus von oben und unten  
mirror polished finish, cooling with 2 cooling elements from the top and base

base inox brillante, con 2 acum. de frio, 1 arriba y 1 en la base

base inox poli brillant, 2 plaques de froid (1 dans le couvercle, 1 dans le socle)

	cm	↑ cm	ltr.
10800	21 x 32	43	4
10700	23 x 35	52	6



### Saftdispenser DUO „TOP FRESH“

juice dispenser  
dispensador de zumo  
distributeur à jus de fruit



hochglanzpoliert, Kühlung durch 2 Kühllakkus von oben und unten

mirror polished finish, cooling with 2 cooling elements from the top and base

base inox brillante, con 2 acum. de frio, 1 arriba y 1 en la base

base inox poli brillant, 2 plaques de froid (1 dans le couvercle, 1 dans le socle)

	cm	↑ cm	ltr.
10720	42 x 32	52	2 x 6



### Saft- und Milchdispenser MIX „TOP FRESH“

juice and milk dispenser  
dispensador mixto zumo y leche  
distributeur mixte à lait et à jus de fruit



6 Liter Saftbehälter, 5 Liter Milchkanne, Kühlung durch Kühllakkus von oben und unten

6 liters juice container, 5 liters milkcan, cooling with cooling elements from the top and base

recipiente de zumo 6 litros, recipiente de leche 5 litros, 2 enfriadores  
réipient à jus 6 l, réipient à lait 5 l, plaques de froid

	cm	↑ cm	ltr.
10760	42 x 35	52	6 + 5



### Iso-Dispenser

insulated dispenser  
dispensador isotérmico  
distributeur de boisson isothermique



für heiÙe und kalte Getränke

for hot and cold drinks

para bebidas frías y calientes

pour boissons chaudes ou froides

	Ø cm	↑ cm	ltr.
10788	24	42	9,5

Hahn / tap / grifo / robinet

10789





1) Deckel / cover / tapa / couvercle

für ltr. / for ltr. / para ltr. / pour ltr.

10701	6
10801	4

2) Kühlakku / cooler / acumulador de frío / accumulateur de froid

für ltr. / for ltr. / para ltr. / pour ltr.

10777	4 / 6
-------	-------

3) Behälter inkl. Zapfhahn / container incl. tap  
recipiente con grifo / récipient avec robinet

für ltr. / for ltr. / para ltr. / pour ltr.

10703	6
10803	4

3) Behälter ohne Zapfhahn / container without tap  
recipiente sin grifo / récipient sans robinet

für ltr. / for ltr. / para ltr. / pour ltr.

10704	6
10804	4

4) Non-Drip Hahn / non-drip tap / grifo anti-goteo / robinet anti-goutte

für ltr. / for ltr. / para ltr. / pour ltr.

10707	6
10807	4

5) Dichtungsring / sealing ring / arandela / rondelle

für ltr. / for ltr. / para ltr. / pour ltr.

10608	4 / 6
-------	-------

6) Einsatz / insert / aro inox / cercle inox

für ltr. / for ltr. / para ltr. / pour ltr.

10708	6
10808	4

7) Standfuß 18/10 Edelstahl / column 18/10 stainless steel  
base inox 18/10 / socle inox 18/10

für ltr. / for ltr. / para ltr. / pour ltr.

10709	6
10809	4

8) Tropfgitter 18/10 Edelstahl / drip lattice 18/10 stainless steel  
rejilla recoge gotas 18/10 / grille ramasse-gouttes 18/10

für ltr. / for ltr. / para ltr. / pour ltr.

10712	6
10713	DUO
10812	4

9) Bodenplatte 18/10 Edelstahl / footing 18/10 stainless steel  
base de 18/10 acero / socle inox 18/10

für ltr. / for ltr. / para ltr. / pour ltr.

10710	6
10711	DUO / 6 + 6
10814	4

1x Dichtung, 2x Dichtungsring (transparent), 1x Dichtungsring (s / w)  
1x seal, 2x sealing ring (transparent), 1x sealing ring (b / w)  
Zubehör / Reinigungsset - für die regelmäßige Reinigung

10714	für Zapfhahn 10707
10715	für Zapfhahn 10807
10716	für Zapfhahn 10907
10717	für Zapfhahn 10867



# BEVERAGE DISPENSER

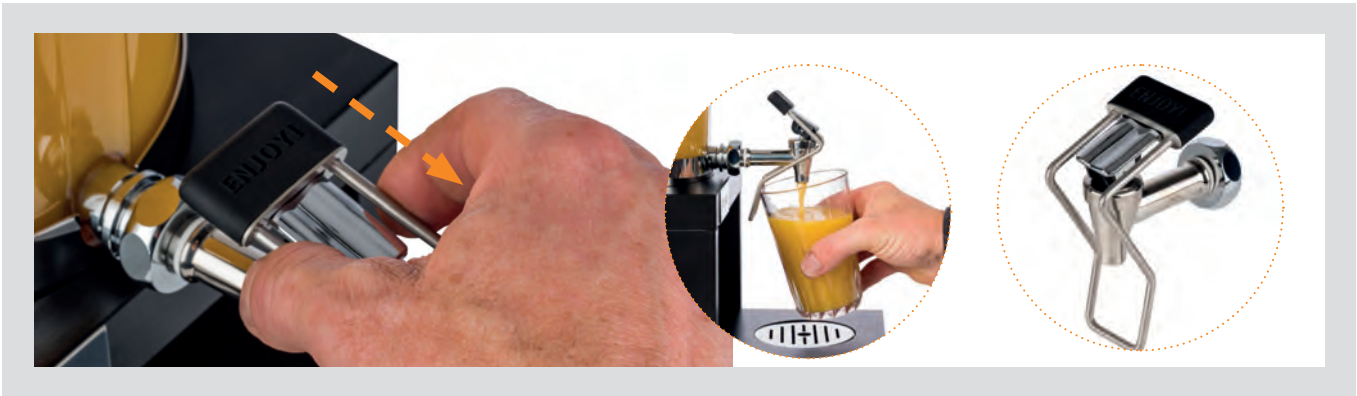

Der Adapter passt auf alle Dispenser der Serien TOP FRESH, BRIDGE und SUNDAY und kann ganz einfach installiert werden

The adapter fits all dispensers of the series TOP FRESH, BRIDGE and SUNDAY and can be installed very easily.

El adaptador se adapta a todos los dispensadores de las series TOP FRESH, BRIDGE y SUNDAY y puede ser instalado fácilmente.

L'adaptateur s'adapte à tous les distributeurs des séries TOP FRESH, BRIDGE et SUNDAY et peut être installé très facilement.



## Adapter „TOP FRESH“

adapter  
adaptador  
adaptateur



handkontaktloser Adapter, einfach zu installieren  
adapter touchless for tap, easy to install  
adaptador sin contacto para grifo  
adaptateur sans contact manuel, facile à installer

	cm	↑ cm
10802	12 x 4,5	5,5



Einfach den Adapter an der dafür vorgesehenen Öffnung auf den Hebel des Zapfhahns stecken.

Simply plug the adapter onto the lever of the tap at the opening provided.

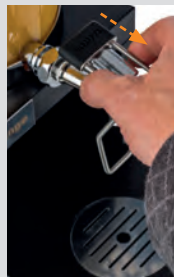

Anschließend den Adapter nach unten festziehen. Durch das Nach-Vorne-Drücken des unteren Edelstahlbügels mit Hilfe des Glases, wird der Hebel des Zapfhahns betätigt und das Getränk fließt völlig handkontaktlos in das Glas.

Then tighten the adapter downwards. By pushing the lower stainless steel bracket forward with the help of the glass, the lever of the tap is activated and the drink flows into the glass completely without hand contact.

passend für / suitable for:



Saftdispenser „TOP FRESH“  
Katalog Seite 46  
juice dispenser,  
catalog page 46



Milchkanne „TOP FRESH“  
Katalog Seite 51  
milk dispenser,  
catalog page 51



Saftdispenser „BRIDGE“  
Katalog Seite 20  
juice dispenser,  
catalog page 20



**Saftdispenser „SUNDAY“**

juice dispenser  
dispensador de zumo  
distributeur à jus de fruit



**matt poliert, Kühlung durch 2 Kühlakkus von oben und unten**  
satin polished finish, cooling with 2 cooling elements from the top and base  
acabado pulido brillante, 2 acum. de frío (1 en la base y 1 en la tapa)  
inox mat, 2 accus. de froid (1 socle et 1 couvercle)

	cm	↑ cm	ltr.
10860	21 x 35	48	6



**Saft- / Milchdispenser „SUNDAY“**

juice and milk dispenser  
dispensador mixto zumo y leche  
distributeur mixte à lait et à jus de fruit



**matt poliert, Behälter gefrostet, Kühlung durch 2 Kühlakkus von oben und unten**  
satin polished finish, canister frosted look, cooling with 2 cooling elements from the top and base  
inox acabado pulido mate, 1 recipiente policarbonato aspecto glaseado, 2 enfriadores en la base y en la tapa  
inox mat, récipient polycarbonate opaque, 2 accus. de froid dans le socle et dans le couvercle

	cm	↑ cm	ltr.
10865	21 x 35	48	6



**Saftdispenser DUO „SUNDAY“**

juice dispenser  
dispensador de zumo doble  
distributeur à jus de fruit double



**matt poliert, Kühlung durch 4 Kühlakkus von oben und unten**  
satin polished finish, cooling with 4 cooling elements from the top and base  
inox acabado pulido mate, 4 enfriadores en la base y en la tapa  
inox mat, 4 accus. de froid (socle et couvercle)

	cm	↑ cm	ltr.
10862	35 x 45	48	2 x 6



**Saft- / Milchdispenser DUO „SUNDAY“**

juice and milk dispenser  
dispensador mixto zumo y leche  
distributeur mixte à lait et à jus de fruit



**matt poliert, 1 Behälter gefrostet, 1 Behälter transparent, 4 Kühlakkus von oben und unten**  
satin polished finish, 1 canister frosted look, 1 canister transparent, cooling with 4 cooling elements from the top and base  
inox mate, 1 recipiente opaco, 1 recipiente transparente, 4 enfriadores (base y tapa)  
inox mat, 1 récipient opaque, 1 récipient transparent, 4 accus. de froid (socle et couvercle)

	cm	↑ cm	ltr.
10864	35 x 45	48	2 x 6

**Saftbehälter transparent, ohne Zapfhahn / juice canister transparent, without tap / contenedor transparente sin grifo / récipient cylindrique sans le robinet**

	Ø cm	↑ cm	ltr.
10806	22	26	6

**Milchbehälter, gefrostet, ohne Zapfhahn / milk canister, frosted look, without tap / contenedor de leche, efecto glaseado, sin grifo / récipient cylindrique mat (idéal pour le lait) sans le robinet**

	Ø cm	↑ cm	ltr.
10805	22	26	6

**Hahn / tap / grifo / robinet**

10867			
-------	--	--	--



## BEVERAGE DISPENSER



NEW

inkl. Crushediceröhre  
incl. crushed ice tube

5 ltr.

### Saftdispenser „TOWER“

juice dispenser  
dispensador de zumo  
distributeur à jus de fruit

aus Edelstahl, inklusive Crushediceröhre  
made of stainless steel, inclusive crushed ice tube  
de acero inoxidable con tubo para hielo picado  
en acier inox avec tube de glace pilée



	cm	↑ cm	ltr.
10440	35 x 23	75	5



Edelstahl Zapfhahn  
stainless steel tap



NEW



Massives Buchenholz gebeizt  
solid beech wood, stained

### Milchdispenser „BRIDGE“

milk dispenser  
dispensador de leche  
distributeur à lait

Edelstahl Dispenser mit 1 Kühllakku im Standfuß inkl. touchless adapter  
stainless steel dispenser with 1 cooling element in stand incl. touchless adapter  
dispensador de acero inoxidable con 1 acumulador de frío en la base y con adaptador sin contacto para grifo  
distributeur en acier inox avec 1 accumulateur de froid sand le socle et avec adaptateur sans contact manuel



	cm	↑ cm	ltr.	Farbe / Colour
10837	31 x 20	39	3	■
10839	39 x 22	45	5	■



NEW



Massives Ahornholz  
solid maple wood

### Milchdispenser „BRIDGE“

milk dispenser  
dispensador de leche  
distributeur à lait

Edelstahl Dispenser mit 1 Kühllakku im Standfuß inkl. touchless adapter  
stainless steel dispenser with 1 cooling element in stand incl. touchless adapter  
dispensador de acero inoxidable con 1 acumulador de frío en la base y con adaptador sin contacto para grifo  
distributeur en acier inox avec 1 accumulateur de froid sand le socle et avec adaptateur sans contact manuel



	cm	↑ cm	ltr.	Farbe / Colour
10836	31 x 20	39	3	■
10838	39 x 22	45	5	■



**Saftdispenser „BRIDGE“**

juice dispenser  
dispensador de zumo  
distributeur à jus



**Kühlung durch 2 Kühllakkus von oben und unten**  
cooling with 2 cooling elements from the top and base  
2 acum. de frío 1 en la base y 1 en la tapa  
2 plaques de froid 1 dans le couvercle, 1 dans le socle

	cm	↑ cm	ltr.	Farbe / Colour
10872	31,0 x 20	42	4	■
10873	35,5 x 22	50	6	■

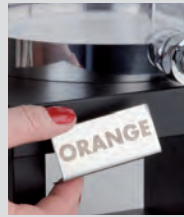

inkl. 3 Magnetschilder: ORANGE, APPLE, GRAPEFRUIT  
including 3 magnetic signs: ORANGE, APPLE, GRAPEFRUIT



**Saftdispenser „BRIDGE“**

juice dispenser  
dispensador de zumo  
distributeur à jus



**Kühlung durch 2 Kühllakkus von oben und unten**  
cooling with 2 cooling elements from the top and base  
2 acum. de frío 1 en la base y 1 en la tapa  
2 plaques de froid 1 dans le couvercle, 1 dans le socle

	cm	↑ cm	ltr.	Farbe / Colour
10870	31,0 x 20	42	4	■
10871	35,5 x 22	50	6	■

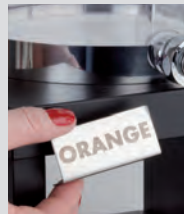

inkl. 3 Magnetschilder: ORANGE, APPLE, GRAPEFRUIT  
including 3 magnetic signs: ORANGE, APPLE, GRAPEFRUIT



**Milchkanne „TOP FRESH“**

milk dispenser  
dispensador de leche  
distributeur à lait



**hochglanzpoliert, 1 Kühllakku im Standfuß, „original Milchkanne mit Henkel“**  
mirror polished finish, 1 cooler in base, original milkcan  
inox brillante, 1 acumulador de frío en la base, recipiente „lechera“  
inox poli brillant, 1 accum. de froid dans le socle, design „pot à lait“

	cm	↑ cm	ltr.
10830	21 x 32	39	3
10750	23 x 35	45	5

**Milchkanne ohne Zapfhahn / milkcan without tapjarra de leche sin grifo / récipient à lait sans robinet**

	Ø cm	↑ cm	ltr.
10833	16	22	3
10663	22	26	5

## BEVERAGE DISPENSER



### Milchkanne „TOP FRESH“

milk dispenser  
dispensador de leche  
distributeur à lait



inkl. Porzellanschild zum Beschriften, 1 Kühllakku im Fuß  
incl. porcelain sign, 1 cooler in base  
incluye cartelito en porcelana, 1 enfriador en la base  
indicateur en porcelaine inclus, plaque de froid dans le socle

	cm	↑ cm	ltr.
10850	31 x 21	42	4



### Milchkanne „TOP FRESH“

milk dispenser  
dispensador de leche  
distributeur à lait



Buchen-Holz versiegelt, inkl. Porzellanschild zum Beschriften, 1 Kühllakku im Fuß  
beech wood, waterproof, incl. porcelain sign, 1 cooler in base  
madera de haya, resistente al agua, incluye placa de porcelana, 1 enfriador en la base  
socle bois hêtre traité, indicateur en porcelaine inclus, plaque de froid dans le socle

	cm	↑ cm	ltr.
10840	23 x 32,0	42	4
10757	27 x 38,5	45	8

Milchkanne Porzellan, ohne Zapfhahn / milkcan porcelain, without tap / jarra de leche sin grifo / récipient en porcelaine sans robinet

	Ø cm	↑ cm	ltr.
10825	18	25	4
10758	22	26	8

Deckel für 10840, 10850 / cover for 10840, 10850 / tapa para 10840, 10850 / couvercle pour 10840, 10850

10859

Deckel für 10757 / cover for 10757 / tapa para 10757 / couvercle pour 10757

10759

Schild und Kette / shield and chain / placa y cadena / indicateur porcelaine avec chaînette

10756

Zapfhahn / tap / grifo / robinet

10907





**Saftdispenser „INOX STAR“**

juice dispenser  
dispensador de zumo  
distributeur à jus de fruit



**Edelstahl-Crushed Ice Röhre herausnehmbar**

stainless steel crash ice tube  
con tubo inox refrigerante extraíble para hielo picado  
avec tube inox réfrigérant amovible pour glace pilée

	cm	↑ cm	ltr.
10795	36 x 26	55	8



**Saftdispenser DUO „INOX STAR“**

juice dispenser  
dispensador de zumo  
distributeur à jus de fruit



**Edelstahl-Crushed Ice Röhre herausnehmbar**

stainless steel crash ice tube  
con tubo inox refrigerante extraíble para hielo picado  
avec tubes inox réfrigérants amovibles pour glace pilée

	cm	↑ cm	ltr.
10810	36 x 52	55	2 x 8

**Behälter / container / recipiente / récipient**

	Ø cm	ltr.
10796	22	8



**Kaffeedispenser „HAPPY HOUR“**

coffee dispenser  
dispensador de café  
distributeur de café



**hochglanzpoliert, für warme Getränke, stabil und standfest, inkl. 1 Brennpastenbehälter**  
mirror polished finish, for warm drinks, solid and stable, incl. 1 burner holder  
acabado pulido brillante para bebidas calientes, sólido y estable, incluye un calentador  
brillant, pour boissons chaudes, avec 1 brûleur, robuste et stable

	cm	↑ cm	ltr.
11672	31 x 33,5	54,5	10,5

**Hahn / tap / grifo / robinet**

11671
-------

**Elektro-Heizelement / heating unit / resistencia / résistance**

	cm	↑ cm
12287	21 x 20	6



**Pump-Isolierkanne „BUDGET“**

air pot  
jarra termo  
bouteille isotherme



doppelwandig, Tragegriff, Dreh-Pumpknopf zur leichten Bedienung (close/open), Pumpmechanismus ist leicht zu entnehmen und zu reinigen, aufgeklappt passt die Kanne unter die gängigen Kaffeeautomaten, für heiße und kalte Getränke

double-walled, carrying handle, rotatable Push-Button for easy use (close/open), pump mechanism is easily removable for cleaning, with flipped-back lid, the air pot fits under a wide range of coffee makers, for hot and cold beverages

doble pared, con asa al lateral, tapa girable y a presión para uso fácil (close/open), el mecanismo a presión es fácil de retirar para limpiar, con la tapa abierta la jarra se puede usar con casi todas las cafeteras corrientes, para bebidas frías y calientes

double paroi, avec poignée, couvercle à visser et a pression pour facile usage (close/open), le mécanisme a pression est facile à retirer pour le nettoyage, avec la couvercle ouverte la bouteille se peut user avec toutes les machines à café courantes, pour boissons chaudes ou froides

	Ø cm	↑ cm	ltr.	Anzahl der Tassen
10915	13,5	32,5	2,2	17



**Pump-Isolierkanne „PREMIUM“**

air pot  
jarra termo  
bouteille isotherme



doppelwandig, Tragegriff, drehbarer Fuß, Pumpmechanismus und Füllstandsanzeige sind leicht zu reinigen mit 4 unterschiedlichen Inhaltsbeschriftungen für den Pumphebel (coffee, tea, hot water, decaf), aufgeklappt passt die Kanne unter die gängigen Kaffeeautomaten, für heiße und kalte Getränke

double-walled, carrying handle, pivotable feet, pump mechanism and fill level indicator is easily removable for cleaning, includes 4 different beverage signs (coffee, tea, hot water, decaf), with flipped-back lid, the air pot fits under a wide range of coffee makers, for hot and cold beverages

doble pared, con asa al lateral, pié girable, el mecanismo a presión y el indicador óptico del nivel son fácil de limpiar, con 4 etiquetas diferentes para la palanca (coffee, tea, hot water, decaf), con la tapa abierta la jarra se puede usar con casi todas las cafeteras corrientes, para bebidas frías y calientes

double paroi, avec poignée, pied pivotant, le mécanisme a pression et l'indicateur de niveau sont facile à retirer pour le nettoyage, avec 4 étiquettes différents pour la pompe (coffee, tea, hot water, decaf), avec la couvercle ouverte la bouteille se peut user avec toutes les machines à café courantes, pour boissons chaudes ou froides

	Ø cm	↑ cm	ltr.	Anzahl der Tassen
10916	15	37	3	24

Tropfenfänger für Pump-Isolierkanne / drip tray for air pot / recoge gotas para jarra termo / ramasse-gouttes pour bouteilles isotherme

	cm	↑ cm
10917	24 x 18,5	4



**Isolierkanne „ECONOMY“**

vacuum jug  
jarra termo  
bouteille isotherme



robuste Umhüllung mit Polypropylen-Kunststoff, Stabilglaseinsatz, Drehverschluss mit Drucktasten-Bedienung für heiße und kalte Getränke, 8 Tassen

double-walled with glass liner, screw cap with easy push-button pouring system, for hot and cold beverages, 8 cups

exterior de plástico polipropileno, interior aislante de vidrio, con tapa a rosca con cierre dosificador para bebidas frías y calientes, 8 tazas

extérieur en plastique polypropylène, intérieur avec plaque de verre, couvercle à visser, pour boissons chaudes ou froides, 8 tasses

	Ø cm	↑ cm	ltr.	Farbe / Colour
10913	16	20	1	White
10914	16	20	1	Black



**Isolierkanne „CLASSIC“**

vacuum jug  
jarra termo  
bouteille isotherme



doppelwandig, Einhandautomatik, Drehverschluss, für heiße und kalte Getränke  
double-walled, easy push-button pouring system, screw cap, for hot and cold drinks  
doble pared, se maneja con 1 mano, con tapa a rosca, para bebidas frías y calientes  
double paroi, usage à 1 main, couvercle à visser, pour boissons chaudes ou froides

	Ø cm	↑ cm	ltr.	Anzahl der Tassen
10910	14	19	1,0	8
10911	14	22	1,5	12
10912	14	25	2,0	16



**Isolierkanne „ADVANCED“**

vacuum jug  
jarra termo  
bouteille isotherme

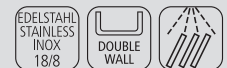

doppelwandig, spülmaschinenfest, Einhandautomatik, aufgeklappt passt die Kanne unter die gängigen Kaffeeautomaten, für heiße und kalte Getränke  
double-walled, dishwasher-safe, easy pouring system, with flipped-back lid, the air pot fits under a wide range of coffee makers, for hot and cold beverages  
doble pared, resistente al lavavajillas, se maneja con 1 mano, con la tapa abierta la jarra se puede usar con casi todas las cafeteras corrientes, para bebidas frías y calientes  
double paroi, résistante au lave-vaisselle, usage à 1 main, avec la couvercle ouverte a bouteille se peut user avec toutes les machines à café courantes, pour boissons chaudes ou froides

	Ø cm	↑ cm	ltr.	Anzahl der Tassen
10921	10,5	13,0	0,3	2,5
10922	10,5	18,0	0,6	5,0
10923	13,0	19,5	1,0	8,0
10924	13,0	23,5	1,5	12,0



## CARAFE



**Glaskaraffe „OLD FASHIONED“, 2 teilig**  
 glass carafe, 2 pcs.: 1 bottle, 1 glass  
 jarra de vidrio, set de 2: 1 botella, 1 vaso  
 carafe en verre, set de 2: 1 bouteille, 1 verre



	Ø cm	↑ cm	ltr.
10690	9,5	31	1,0



1 Flasche 1,0 ltr. / 1 bottle 1,0 ltr.  
 1 Glas 0,3 ltr. / 1 glass 0,3 ltr.



**Glaskaraffe „OLD FASHIONED“**  
 glass carafe  
 jarra de vidrio  
 carafe en verre



**Deckel mit Auffangsieb für Kerne oder Eis**  
 lid with integrated strainer for cores or ice  
 tapa con filtro integrado para los huesos o el hielo  
 couvercle avec filtre intégré pour les pépins ou la glace

	Ø cm	↑ cm	ltr.
10691	12	26	1,8



**Glaskaraffe**  
 glass carafe  
 jarra de vidrio  
 carafe en verre



**Deckel aus Edelstahl matt poliert**  
 lid made of matt polished stainless steel  
 tapa de acero inoxidable pulido mate  
 couvercle en acier inox poli mat

	Ø cm	↑ cm	ltr.
10721	8	25	1,0
10722	8	32	1,2



**Ausgießer für tropffreies Ausgießen**  
 spout for drip-free pouring



**Glaskaraffe**  
 glass carafe  
 jarra de vidrio  
 carafe en verre



**Deckel aus Edelstahl matt poliert, mit integriertem Auffangsieb für Kerne oder Eis**  
 lid made of matt polished stainless steel, with integrated strainer for cores or ice  
 tapa de acero inoxidable pulido mate, con filtro integrado para los huesos o el hielo  
 couvercle en acier inox poli mat, avec filtre intégré pour les pépins ou la glace

	Ø cm	↑ cm	ltr.
10792	10	26	1,5

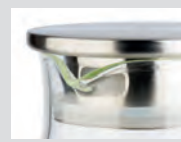

**Deckel mit Doppelfunktion**  
 Lid with double function



**Glaskaraffe „LINES“**

glass carafe  
jarra de vidrio  
carafe en verre



	Ø cm	↑ cm	ltr.
10738	8	27	0,9



inkl. Korkdeckel  
incl. cork cover



**Glaskaraffe „DOTS“**

glass carafe  
jarra de vidrio  
carafe en verre



	Ø cm	↑ cm	ltr.
10739	8	27	0,9



inkl. Korkdeckel  
incl. cork cover



**Glaskaraffe „WABE“**

glass carafe  
jarra de vidrio  
carafe en verre



	Ø cm	↑ cm	ltr.
10741	8	28	0,8



inkl. Holzkorken mit Silikondichtung  
incl. wooden cork with silicone gasket



**Glaskaraffe „DIAMOND“**

glass carafe  
jarra de vidrio  
carafe en verre



	Ø cm	↑ cm	ltr.
10742	8	28	0,8



inkl. Holzkorken mit Silikondichtung  
incl. wooden cork with silicone gasket

## CARAFE



### Flasche „STRIPES“ bottle botella bouteille



	Ø cm	↑ cm	ltr.
10748	9	28,5	1



### Flasche „STRIPES“ bottle botella bouteille



	Ø cm	↑ cm	ltr.
10749	9	28,5	1



### Kühlkaraffe, 3-teilig „COOL“

cooling carafe, 3 pcs.  
jarra fría, set de 3  
pichet rafraîchisseur, set 3



1 Glaskaraffe mit Edelstahl Ausgießer, öffnet und schließt selbstständig  
+ 1 verchromter Fuß + 1 Kühlakku, werden bis zu 4 Stunden gekühlt

1 glass carafe with stainless steel pourer, open / closing autonomous  
+ 1 chrome plated base + 1 cooling pack, up to 4 hours cooled beverages

1 botella de vidrio con vertedor inox y silicona, con autocierre  
+ 1 base cromada + 1 placa de frio que mantiene las bebidas frescas hasta unas 4 horas

pichet en verre avec insert verseur inox et silicone, fermeture automatique  
+ socle chromé + accumulateur de froid pour maintenir les boissons froides jusqu'à 4 heures

	Ø cm	↑ cm	ltr.
10762	16	27	1,4

### Glasflasche / glass carafe / jarra de vidrio / pichet verre

	Ø cm	↑ cm
10761	16	26

### Kühlakku rund, schwarz / cooler round, black / cooler / accumulateur de froid, noir

	Ø cm	↑ cm
10752	10,5	2



Edelstahl-Ausgießer  
stainless steel pourer





**Glaskaraffe**

glass carafe  
jarra  
pichet en verre



der Deckel öffnet sich beim Ausgießen automatisch  
cover opens automatically while pouring  
la tapa se abre automáticamente durante el vertido  
le couvercle s'ouvre seul pendant le service, résistant à la chaleur

	Ø cm	↑ cm	ltr.
10766	9,5	29	1



**Glaskaraffe**

glass carafe  
jarra  
pichet verre



Deckel aus Edelstahl matt poliert  
stainless steel cover  
tapa de acero inoxidable  
couvercle inox



Ausgießer für tropffreies ausgießen  
spout for drip-free pouring

	Ø cm	↑ cm	ltr.
10764	9,5	27	1,5



**Saft- / Wasserkanne**

juice / water pitcher  
jarra de zumo / agua  
pichet à eau ou jus de fruit



mit Eiswasser-Röhre  
with water ice tube  
con tubo para hielo  
avec tube à glaçons plongeant pour réfrigérer

	cm	↑ cm	ltr.
10769	19 x 13	27	2,8



**Saftkanne**

juice pitcher  
jarra de zumo  
pichet à jus de fruit



mit Eiswasser-Röhre  
with water ice tube  
con tubo para hielo  
avec tube à glaçons plongeant pour réfrigérer

	Ø cm	↑ cm	ltr.
10770	18	29	3

# CARAFE



**Saftkanne**  
juice pitcher  
jarra de zumo  
pichet à jus de fruit



	Ø cm	↑ cm	ltr.
10775	12	26	2



**Saftkanne**  
juice pitcher  
jarra de zumo  
pichet à jus de fruit



	Ø cm	↑ cm	ltr.
10776	14	29	2,5



**Pitcher**  
pitcher  
jarra  
pichet



	Ø cm	↑ cm	ltr.
93105	13	21	1,5

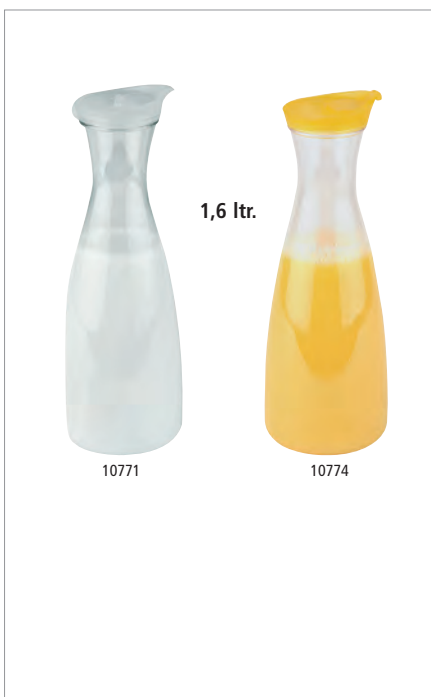

**Karaffe / Kanne**  
bottle  
botella  
bouteille



**Schraubdeckel mit aromadichtem Verschluss**  
screwed lid, aroma-tight  
tapón de rosca, impide la fuga de aromas  
bouchon à visser, ne laisse pas passer les arômes

	Ø cm	↑ cm	ltr.	Farbe / Colour
10771	11	30	1,6	
10772	11	30	1,6	
10773	11	30	1,6	
10774	11	30	1,6	



**Kühlbox „FROSTY“**

bottle cooler  
enfriador de botellas  
rafraichisseur de bouteilles

mit herausnehmbarem Einsatz für 4 Flaschen

with removable insert for 4 bottles  
con inserto extraíble para 4 botellas  
avec insert amovible pour 4 bouteilles



Abb. ohne Einsatz  
illustration without insert

	cm	↑ cm	ltr.	hole ø cm
93230	27 x 27	15	7,5	11

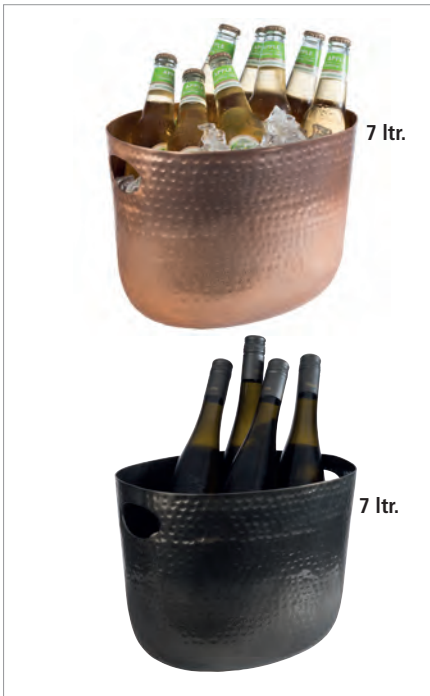

**Wein- / Sektkühler**

wine / champagne bowl  
cubitera para vino y cava  
seau à vin ou champagne

gehämmerte Oberfläche mit 2 seitlichen Eingriffen

hammered surface with 2 handles on the side  
superficie martillada con 2 asas  
surface martelée avec 2 poignées



	cm	↑ cm	ltr.	Farbe / Colour
36111	30 x 23,5	23	7	 copper-look
36112	30 x 23,5	23	7	 gunmetal-look







**Getränkewanne „TIN“**

beverage tub  
barreño botellines  
bassine à glace

Metall verzinkt, mit Kunststoffeinsatz

galvanised metal, with plastic insert  
metal galvanizado, con inserto de plástico  
métal galvanisé, avec insert en plastique



	cm	↑ cm	ltr.	Farbe / Colour
36100	40 x 28	22	11	 copper-look
36101	40 x 28	22	11	 black-metal-look
36095	40 x 28	22	11	 metal-look
36096	50 x 23	23	18	 metal-look



mit Kunststoffeinsatz  
with plastic insert  
con inserto de plástico  
avec insert en plastique



Kreidestift zum  
Beschriften  
chalk marker for writing  
S. 348

# CONFERENCE

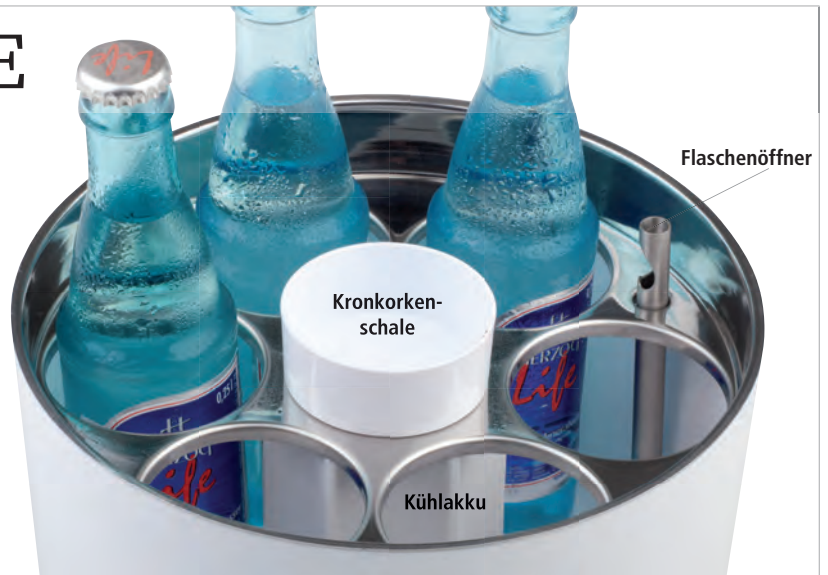

## Flaschenkühler „CONFERENCE“

conference bottle cooler  
enfriador múltiple  
rafraîchisseur

inkl. Kühlakku, Flaschenöffner, Kronkorkenschale,  
mit 6 Öffnungen Ø 6,7 cm für 0,25 - 0,5 Liter-Flaschen

incl. bottle cooler, bottle opener, small cap bowl,  
with 6 holes Ø 6,7 cm for 0,25 to 0,5 liter bottles

con acumulador de frío, abridor, recuperador de chapas,  
6 plazas Ø 6,7 cm, para botellas de 25 a 50 cl

avec accumulateur de froid, décapsuleur, bol récupérateur  
de capsules, 6 places Ø 6,7 cm, pour bouteilles de 25 à 50 cl



	Ø cm	↑ cm	Farbe / Colour
00620	23	15	White
00621	23	15	Black



## Kühlakku

cooler  
acumulador de frío  
accumulateur de froid

	Ø cm	→ cm	Farbe / Colour
00616	7,5	11,5	White
00615	7,5	11,5	Black



## Flaschenöffner

bottle opener  
abridor  
décapsuleur



	Ø cm	→ cm
00617	1	13,5



## Kronkorkenschale

cap bowl  
cuenco para chapas  
bol récupérateur de capsules



	Ø cm	↑ cm	Farbe / Colour
00618	6,5	3	White
00619	6,5	3	Black





**Teekanne „ASIA“**

teapot  
tetera  
théière



aus Gusseisen, innen emailliert, mit abnehmbarem Deckel, inkl. Teesieb aus Edelstahl, ideal für 2-3 Tassen. Geeignet für alle Herdarten.  
made of cast iron, enamelled inside, with removable lid, incl. tea strainer made of stainless steel, ideal for 2-3 cups. Suitable for all types of stoves.

hierro fundido, interior esmaltado, con tapa extraible, incl. colador de té de acero inoxidable, ideal para 2-3 tazas. Apta para todas las placas de cocina.

en fonte, émaillé à l'intérieur, avec couvercle amovible, y compris une passoire à thé en acier inox, idéale pour 2-3 tasses. Convient à tous les types de feux (gaz, vitro ou induction).

	cm	↑ cm	ltr.	Farbe / Colour
10991	19,5 x 18	15	0,8	■
10992	19,5 x 18	15	0,8	■



**Teekanne „ASIA“**

teapot  
tetera  
théière



aus Gusseisen, innen emailliert, mit abnehmbarem Deckel, ohne Teesieb aus Edelstahl  
made of cast iron, enamelled inside, with removable lid, without tea strainer made of stainless steel

hierro fundido, interior esmaltado, con tapa extraible, sin colador de té de acero inoxidable

en fonte, émaillé à l'intérieur, avec couvercle amovible, sans une passoire à thé en acier inox

	cm	↑ cm	ltr.	Farbe / Colour
10990	12,5 x 11	12,5	0,3	■



**Stövchen „ASIA“**

teapot warmer  
calentador de tetera  
chauffe-théière



	Ø cm	↑ cm	Farbe / Colour
10994	13	7,5	■

1-flammiges Stövchen aus Gusseisen mit abnehmbarem Deckel (Lieferung ohne Teelicht).

1-flame cast iron warmer with removable lid (delivery without tealight).

calentador de tetera de hierro fundido con 1 quemador con tapa amovible (se entrega sin vela).

chauffe-théière en fonte à 1 brûleur avec couvercle amovible (livraison sans bougie).

Untersetzer aus Gusseisen mit Antirutsch-Füßchen / cast iron coaster with non-slip feet

	Ø cm	↑ cm	Farbe / Colour
10993	13,5	1,5	■



**NEW FRESH & EASY**



4,5 ltr.

**Cerealienspender „FRESH & EASY“**

cereal dispenser  
dispensador de cereales  
distributeur de céréales



Behälter herausnehmbar, „Feierabend-Deckel“ für das aromadichte Lagern, portionieren durch einfaches Drehen

removable canister, special lid to keep the cereals fresh, easy to use, rotate the button to get the muesli

contenedor movable, tapa especial para mantener los cereales frescos, fácil de usar, se gira el pomo para servir los cereales

réceptif amovible, couvercle spécial pour conserver les céréales, usage facile en tournant le bouton

	cm	↑ cm	ltr.	Farbe / Colour
11840	22 x 17,5	52	4,5	■

**Kunststoffbehälter / canister / contenedor / réceptif**

	Ø cm	ltr.
11808	24	4,5



2 x 4,5 ltr.

**Cerealienspender Duo „FRESH & EASY“**

cereal dispenser  
dispensador de cereales  
distributeur de céréales



Behälter herausnehmbar, „Feierabend-Deckel“ für das aromadichte Lagern, portionieren durch einfaches Drehen

removable canister, special lid to keep the cereals fresh, easy to use, rotate the button to get the muesli

contenedor movable, tapa especial para mantener los cereales frescos, fácil de usar, se gira el pomo para servir los cereales

réceptif amovible, couvercle spécial pour conserver les céréales, usage facile en tournant le bouton

	cm	↑ cm	ltr.	Farbe / Colour
11841	22 x 35	52	2 x 4,5	■

**Kunststoffbehälter / canister / contenedor / réceptif**

	Ø cm	ltr.
11808	24	4,5



4,5 ltr.

**Cerealienspender „FRESH & EASY“**

cereal dispenser  
dispensador de cereales  
distributeur de céréales



**Behälter herausnehmbar, „Feierabend-Deckel“ für das aromadichte Lagern, portionieren durch einfaches Drehen**

removable canister, special lid to keep the cereals fresh, easy to use, rotate the button to get the muesli  
contenedor movable, tapa especial para mantener los cereales frescos, fácil de usar, se gira el pomo para servir los cereales  
récipient amovible, couvercle spécial pour conserver les céréales, usage facile en tournant le bouton

	cm	↑ cm	ltr.
11805	22 x 17,5	52	4,5



2 x 4,5 ltr.

**Cerealienspender Duo „FRESH & EASY“**

cereal dispenser  
dispensador de cereales  
distributeur de céréales



**Behälter herausnehmbar, „Feierabend-Deckel“ für das aromadichte Lagern, portionieren durch einfaches Drehen**

removable canister, special lid to keep the cereals fresh, easy to use, rotate the button to get the muesli  
contenedor movable, tapa especial para mantener los cereales frescos, fácil de usar, se gira el pomo para servir los cereales  
récipient amovible, couvercle spécial pour conserver les céréales, usage facile en tournant le bouton

	cm	↑ cm	ltr.
11807	22 x 35	52	2 x 4,5

**Kunststoffbehälter / canister / contenedor / récipient**

	Ø cm	ltr.
11808	24	4,5



**Cerealienspender „ROTATION“**

cereal dispenser  
dispensador de cereales  
distributeur de céréales



**matt poliert, drehbarer massiver Ständer, Behälter herausnehmbar, inkl. Frischhaltedeckel**  
satin polished finish, rotating food, canister removable, incl. airtight covers  
pulido acabado satinado, giratorio, incluye tapas herméticas  
mat satiné, rotatif, inclut couvercles hermétiques

	Ø cm	↑ cm	ltr.
11970	38	54	3 x 4,5

**Kunststoffbehälter / canister / contenedor / récipient**

	Ø cm	ltr.
11808	24	4,5



**Cerealienspender „ROTATION“**

cereal dispenser  
dispensador de cereales  
distributeur de céréales



**Buchen-Holz versiegelt, drehbarer massiver Ständer, Behälter herausnehmbar, inkl. Frischhaltedeckel**

wood beech covered waterproof, rotating food, canister removable, incl. airtight cover  
tapa en madera de haya resistente al agua, pie giratorio, recipiente removable, incluye tapa hermética  
couvercle en hêtre traitée contre l'humidité, pied rotatif, récipients démontables, inclut couvercles hermétiques

	Ø cm	↑ cm	ltr.
11975	38	54	3 x 4,5



## CEREAL DISPENSER



8,0 ltr.

### Cerealienspender „CLASSIC“

cereal dispenser  
dispensador de cereales  
distributeur de céréales



Portionieren durch einfaches Drehen, Behälter herausnehmbar

canister removable  
contenedor movable  
réceptif amovible

	cm	↑ cm	ltr.
11833	35 x 26,5	68	8



2 x 8 ltr.

### Cerealienspender „CLASSIC DUO“

cereal dispenser  
dispensador de cereales  
distributeur de céréales



Portionieren durch einfaches Drehen, Behälter herausnehmbar

canister removable  
contenedor movable  
réceptif amovible

	cm	↑ cm	ltr.
11834	35 x 50	68	2 x 8



13987

14987

### Cerealienspender „BRIDGE“

cereal dispenser  
dispensador de cereales  
distributeur de céréales



Behälter herausnehmbar, „Feierabend-Deckel“ für das aromadichte Lagern, portionieren durch einfaches Drehen

removable canister, special lid to keep the cereals fresh, easy to use, rotate the button to get the muesli

contenedor movable, tapa especial para mantener los cereales frescos, fácil de usar, se gira el pomo para servir los cereales

réceptif amovible, couvercle spécial pour conserver les céréales, usage facile en tournant le bouton

	cm	↑ cm	ltr.	Farbe / Colour
13987	21 x 20	55,5	4,5	Ahorn
14987	21 x 20	55,5	4,5	Wenge



13965

14965

82328

2,0 ltr.

### Buffetständer „GOOD MORNING“

buffet stand  
expositor de buffet  
présentoir de buffet



4-teiliges Set: Holzständer inkl. 3 Gläser mit luftdichtem Klappdeckel

4 pcs.: wood stand included 3 glass with airtight cover

set de 4: soporte, 3 boles de cristal, cierre hermético

set de 4: présentoir, 3 bols en verre, fermeture hermétique

	cm	Farbe / Colour
13965	43 x 17	Ahorn
14965	43 x 17	Wenge

Glas mit luftdichtem Klappdeckel / glass with airtight cover / cristal, cierre hermético / verre, fermeture hermétique

	cm	↑ cm	ltr.
82328	12 x 12	22	2



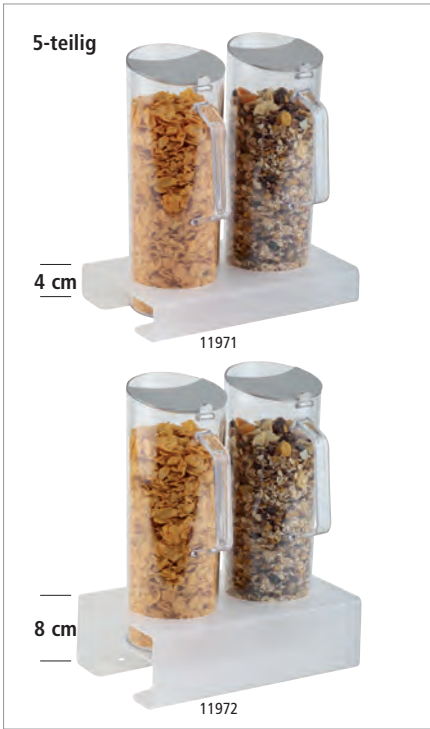

**Cerealien-Bar**

cereal-bar  
barra para dispensador de cereales  
bar à céréales



**5-teiliges Set: mit Ständerhöhe 4 oder 8 cm: 1 Ständer aus Acryl gefrostet und rutschfest + 2 Karaffen mit schwenkbarem Edelstahl-Deckel + 2 luftdichte Frischhaltedeckel**

5 pcs.: with stand heights 4 or 8 cm: 1 stand acryl frosted and anti-slip + 2 pitchers with stainless steel flap lid + 2 airtight covers

set de 5: stands a diferentes alturas, 4 u 8 cm: 1 stand acryl + 2 jarras con tapa de solapa de acero inoxidable + 2 tapas herméticas adicionales

set de 5: supports à différentes hauteurs: 4 ou 8 cm - 1 support acrylique satiné antiglisse + 2 pichets à céréales avec couvercle à charnière inox + 2 couvercles hermétiques

	cm	↑ cm	ltr.
11971	26 x 17	28,5	2 x 1,5
11972	26 x 17	32,5	2 x 1,5



ideal für Stufenpräsentation  
best for staged presentations

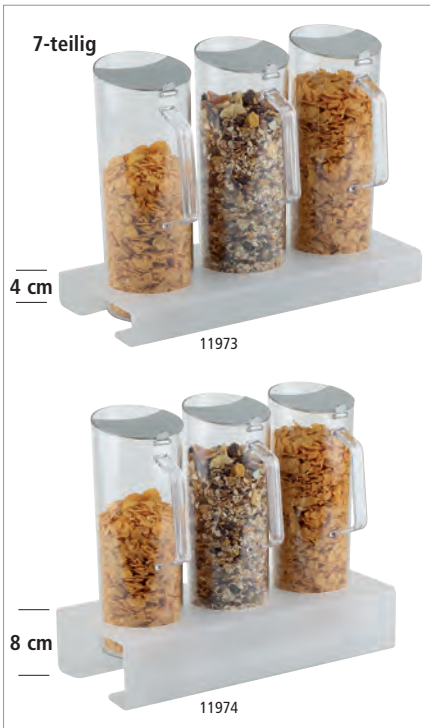

**Cerealien-Bar**

cereal-bar  
barra para dispensador de cereales  
bar à céréales



**7-teiliges Set: mit Ständerhöhe 4 oder 8 cm: 1 Ständer aus Acryl gefrostet und rutschfest + 3 Karaffen mit schwenkbarem Edelstahl-Deckel + 3 luftdichte Frischhaltedeckel**

7 pcs.: with stand heights 4 or 8 cm: 1 stand acryl frosted and anti-slip + 3 pitchers with stainless steel flap lid + 3 airtight covers

set de 7: con stands a diferentes alturas, 4 u 8 cm: 1 stand acryl + 3 jarras con tapa de solapa de acero inoxidable + 3 tapas herméticas adicionales

set de 7: supports à différentes hauteurs: 4 ou 8 cm - 1 support acrylique satiné antiglisse + 3 pichets à céréales avec couvercle à charnière inox + 3 couvercles hermétiques

	cm	↑ cm	ltr.
11973	38 x 17	28,5	3 x 1,5
11974	38 x 17	32,5	3 x 1,5



ideal für Stufenpräsentation  
best for staged presentations



**Cerealienkaraffe**

cereal pitcher  
jarra de cereales  
pichet à céréales



**schwenkbarer Edelstahl-Deckel, inkl. luftdichtem Frischhaltedeckel**

stainless steel flap lid, incl. 1 airtight cover

tapa de solapa de acero inoxidable, incluye otra tapa hermética

couvercle à charnière inox + couvercle hermétique

	Ø cm	↑ cm	ltr.
10778	10	28	1,5

Frishhaltedeckel / conservation lid / tapa de conservación / couvercle

10668

**NEW** CANISTER



Glasdeckel mit Dichtung  
glass lid with seal

1 ltr.

1,2 ltr.

1,5 ltr.

82265

82266

82267

**Vorratsglas**  
canister with lid  
bote con tapa  
pot en verre avec couvercle



inkl. Glasdeckel mit Dichtung und Beschriftungsfeld, somit bleibt Ihre Ware frisch  
incl. glass lid with seal and labeling field, thus, your goods remain fresh  
incl. tapa de vidrio con junta y el campo de etiquetado, por lo tanto, sus productos permanecen frescos  
y compris couvercle en verre avec joint et le domaine de l'étiquetage, ainsi, vos marchandises restent fraîches

	Ø cm	↑ cm	ltr.
82265	11,0	18,0	1,0
82266	11,5	19,5	1,2
82267	12,0	21,0	1,5



1,0 ltr.

2,0 ltr.

2,5 ltr.

82255

82256

82257

**Vorratsglas „WOODY“**  
canister with lid  
bote con tapa  
pot en verre avec couvercle



Glasbehälter mit Holzdeckel, aromadichter Verschluss  
glass container, aroma-tight screw cap  
recipiente de cristal, tapa con cierre hermético para conservar el aroma  
récipient en verre, couvercle avec fermeture hermétique pour conserver l'arôme

	cm	↑ cm	ltr.
82255	14 x 14	11,0	1,0
82256	14 x 14	17,0	2,0
82257	14 x 14	21,5	2,5



Holzdeckel mit Silikondichtung  
wooden lid with silicone gasket



**Vorratsglas „CLASSIC“**

canister with lid  
bote con tapa  
pot en verre avec couvercle



inkl. Glasdeckel mit Dichtung, somit bleibt Ihre Ware frisch  
incl. glass lid with seal, thus, your goods remain fresh  
incl. tapa de vidrio con junta, por lo tanto, sus productos permanecen frescos  
y compris couvercle en verre avec joint, ainsi, vos marchandises restent fraîches

	Ø cm	↑ cm	ltr.
82250	11,5	16,0	0,9
82251	14,0	21,5	2,0
82252	18,0	26,0	4,0
82253	20,0	30,0	6,0



**Vorratsglas mit luftdichtem Klappdeckel**

glass with airtight cover  
bote con cierre hermético  
pot en verre avec fermeture hermétique



	cm	↑ cm	ltr.
82328	12 x 12	22	2



**Vorratsglas**

canister with lid  
bote con tapa  
pot en verre avec couvercle



Glaskugel mit Löffel, Schraubdeckel mit aromadichtem Verschluss,  
Edelstahl-Löffel mit magnetischem Silikongriff  
tight cover, stainless steel spoon with magnetic silicone handle  
tapa a rosca con cierre hermético, cuchara de acero inoxidable con mango de silicona magnético  
couvercle à vis avec fermeture hermétique, cuillère en acier inox avec manche de silicone aimanté

	cm	↑ cm	ltr.
00636	17 x 12,5	18	1 - 2,2

## CANISTER



seitlich gestellt 1 ltr.  
hochkant gestellt 2,2 ltr.

### Vorratsglas

canister with lid  
bote con tapa  
pot en verre avec couvercle



Glaskugel mit Schraubdeckel, aromadichtem Verschluss, 1 Stck.

glass ball, aroma-tight screw cap, 1 pc.

bote de cristal, tapa a rosca para conservar el aroma, 1 pza

pot en verre, couvercle à vis pour conserver l'arôme, 1 pc.

	cm	↑ cm	ltr.
00637	17 x 12,5	18	1 - 2,2



### Universalbox

box / sweetbox  
caja dispensadora  
boîte distributrice



ideal als Verkaufsbox, mit Frontdeckel

best to present sweets etc., all-purpose, with front lid

la perfecta solución para presentar golosinas, universal, con tapa frontal

la solution idéale pour les friandises et autres, universel, avec couvercle frontal

	cm	↑ cm	Farbe / Colour
11884	23 x 14,5	15	White
11885	23 x 14,5	15	Red



### Weck-Gläser mit Deckel, 2er Set

Weck-glasses with lid, 2 pcs.  
Weck tarros de vidrio con tapa, set de 2  
Weck verrines avec couvercle, set de 2



2 Gläser + 2 Edelstahl Deckel

2 glasses + 2 stainless steel lids

2 tarros + 2 tapas de acero inoxidable

2 verrines + 2 couvercles en acier inox

	Ø cm	↑ cm	ltr.	pcs
82239	11	7,5	0,37	2
82240	11	11	0,58	2



### Weck-Gläser mit Deckel, 2er Set

Weck-glasses with lid, 2 pcs.  
Weck tarros de vidrio con tapa, set de 2  
Weck verrines avec couvercle, set de 2



2 Gläser + 2 Holz Deckel

2 glasses + 2 wooden lids

2 tarros + 2 tapas de madera

2 verrines + 2 couvercles en bois

	Ø cm	↑ cm	ltr.	pcs
82243	11	7,5	0,37	2
82244	11	11	0,58	2



# BUFFET STAND

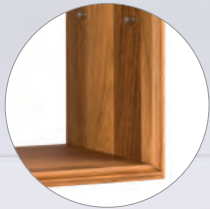

Eichenholz geölt  
oak wood oiled

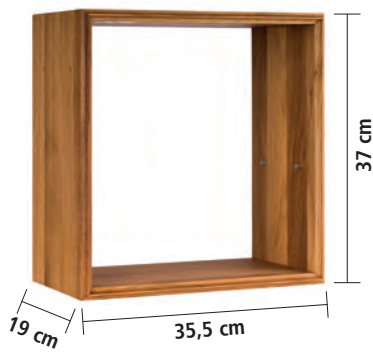

83832  
Tablett / tray  
GN 1/3



83832  
GN 1/3



84187  
GN 1/3

## Buffetständer „WINDOW“

buffet stand  
soporte para buffet  
présentoir buffet

HOLZ  
WOOD

Eichenholz geölt  
oak wood oiled  
madera de roble aceitada  
bois de chêne huilé

	cm	↑ cm	
11740	35,5 x 19	37	inkl. 20 Haltestiften für Einlegeböden / incl. 20 fixing pins for shelves



inkl. 20 Haltestifte  
incl. 20 fixing pins

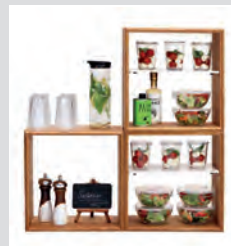

Präsentationsmöglichkeiten  
presentation examples



geeignet für GN 1/3 Tablett / for GN 1/3 trays / para bandejas GN 1/3 / pour plateaux GN 1/3

	cm	↑ cm	Farbe / Colour
83832	32,5 x 17,6	2,5	White
84187	32,5 x 17,6	1,5	White
84197	32,5 x 17,6	1,5	Black
83481	32,5 x 17,6	3,0	White
83491	32,5 x 17,6	3,0	Black



83481  
GN 1/3

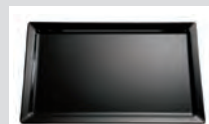

83491  
GN 1/3

# BUFFET BRIDGE



Präsentationsmöglichkeit / presentation opportunity



## Buffetbrücke

buffet bridge  
puente de buffet  
pont de buffet



### Buffetbrücke aus Akazienholz

buffet bridge from acacia wood  
puente de buffet de madera de acacia  
pont de buffet en bois d'acacia

	cm	↑ cm
33285	45 x 17	22
33286	70 x 17	22



Lieferung erfolgt demontiert  
delivery disassembled



## Buffetgestell

buffet stand  
soporte para buffet  
présentoir buffet



### 3-stufig, geeignet für runde und rechteckige Körbe, platzsparend zusammenklappbar

3-tier, usable for round and rectangular baskets, can be pushed together for place saving  
3 alturas, apto para cestas redondas y rectangulares, se puede plegar para ahorrar espacio  
3 hauteurs, pour corbeilles rondes ou rectang, la structure s'ouvre ou se ferme pour réduire l'encombrement

	cm	↑ cm
33232	59 x 30,5	59

Tisch- und Buffetkorb, rund „ECONOMIC“ / buffet basket, round / cesta de bufé redonda / corbeille de buffet ronde

	Ø cm	↑ cm	Farbe / Colour
40144	39	10	



**2-stufige Etagère „IRON“**

2-tier tray  
bandeja con dos alturas  
étagère carré 2 hauteurs



- 1 Gestell aus schwarzem Metall
- 2 Akazienholzplatten: Ø 23 cm, H: 1,5 cm / Ø 30 cm, H: 2,5 cm
- 2 Beschriftungsschilder 15 x 10,5 cm

- 1 black metal frame
- 2 acacia wood panels: Ø 23 cm, H: 1,5 cm / Ø 30 cm, H: 2,5 cm
- 2 inscription labels 15 x 10.5 cm
- 1 soporte metálico negro
- 2 tableros de madera de acacia: Ø 23 cm, H: 1,5 cm / Ø 30 cm, H: 2,5 cm
- 2 etiqueta de inscripciones 15 x 10,5 cm
- 1 support métallique noir
- 2 panneaux en bois d'acacia: Ø 23 cm, H: 1,5 cm / Ø 30 cm, H: 2,5 cm
- 2 étiquette d'inscriptions 15 x 10,5 cm

	cm	↑ cm
30334	47 x 30	44



**Buffetgestell „TRIANGLE“**

buffet stand  
expositor de buffet  
présentoir buffet



	cm	↑ cm	Farbe / Colour	
13966	53 x 21	50		Ahorn / maple
14966	53 x 21	50		Wenge / wenge



passende Akazienholzplatte  
fitting acacia wood panels

Gestell mit abgerundeten Füßen  
frame with rounded feet

**Buffetgestell „BIRDCAGE“**

buffet stand  
soporte para buffet  
présentoir buffet



Gestell aus schwarzem Metall, inkl. 2 Akazienholzplatten / black metal frame, incl. 2 acacia wood panels / soporte metálico negro, incl. 2 tableros de madera de acacia / support métallique noir, avec 2 panneaux en bois d'acacia

	Ø cm	↑ cm
33206	26	54

Ersatz-Holzplatte / spare wooden panel / tablero de madera de recambio / panneau en bois de rechange

	Ø cm	↑ cm
33207	25	1

## BUFFET DISPLAY



### Dressingtopf-Display / -Station

wooden station for 3 dressing pots  
expositor de madera para 3 salseras  
présentoir en bois pour 3 pots à sauce



inkl. 3 Beschriftungsschilder aus Metall  
incl. 3 metal labels  
incl. 3 etiquetas de metal  
incl. 3 étiquettes métalliques

	cm	↑ cm
84863	40 x 16	9



passend für 83311, 83867, 30060  
suitable for 83311, 83867, 30060



### Dressingtopf „PASTELL“

dressing pot  
salsera  
pot à sauce



	cm	↑ cm	ltr.	Farbe / Colour
84862	13	19,5	1,5	■
84860	13	19,5	1,5	■
84861	13	19,5	1,5	■

Beschriftungsetiketten, 72 Stück / labeling labels, 72 pcs.  
etiquetas, 72 pzs / étiquettes, 72 pcs.

	cm	Farbe / Colour
00069	8 x 4,6	■



mit Antirutschfüßchen  
with non-slip feet  
con pies antideslizantes  
avec pieds antidérapants



stapelbar  
stackable  
apilable  
empilable



### Dressingtopf, doppelwandig „PROFI“

dressing pot, double wall  
salsera alta, doble pared  
pot à sauce, double paroi



beste Isoliereigenschaften  
best insulating properties  
muy aislante  
très isolant

	Ø cm	↑ cm	ltr.
30060	13	19	1,4

Beschriftungsetiketten, 72 Stück / labeling labels, 72 pcs.  
etiquetas, 72 pzs / étiquettes, 72 pcs.

	cm	Farbe / Colour
00069	8 x 4,6	■





passend für 84863  
suitable for 84863



Dressingtopf „CASUAL“  
dressing pot  
salsera  
pot à sauce



	cm	↑ cm	ltr.	Farbe / Colour
83867	12	21,5	1	■



passend für 84863  
suitable for 84863



Dressingtopf „CASUAL“  
dressing pot  
salsera  
pot à sauce



	cm	↑ cm	ltr.	Farbe / Colour
83868	12	21,5	1	■



Dressingtopf  
dressing pot  
salsera  
pot à sauce



Deckel mit Löffelaussparung  
cover notched for spoon  
tapa agujereada para el cucharón  
couvercle avec espace pour la louche

	Ø cm	↑ cm	ltr.
83309	18,5	17	2,3
83310	17,0	15	2,0
83311	13,0	13	0,8



passend für 84863  
suitable for 84863

## BUFFET DISPLAY



### Schale „ELEMENT“

bowl  
cuenco  
bol



	Ø cm	↑ cm	ltr.
30000	22	6,0 / 10,5	1,1
30001	26	7,5 / 13,0	1,7
30002	29,5	8,5 / 14,5	2,5



möbelschonende Unterseite  
furniture-friendly underside



Präsentationsmöglichkeiten  
presentation example



### Schale „COCONUT“

bowl  
cuenco  
bol



	Ø cm	↑ cm	ltr.
30020	18	9,5	1
30021	23	12,5	2,2



möbelschonende Unterseite  
furniture-friendly underside



### Buffetständer

buffet stand  
expositor de buffet  
présentoir buffet



Akazienholz  
acacia wood  
madera de acacia  
bois d'acacia

	Ø cm	↑ cm
33255	15	10
33256	25	15

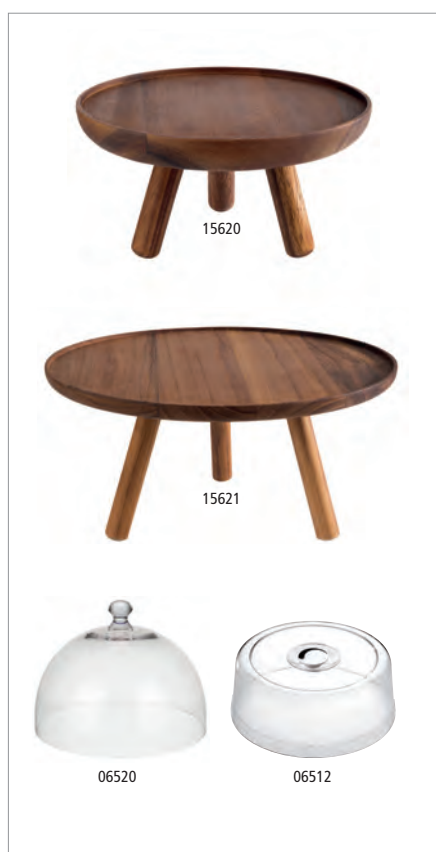

**Buffetständer „ACACIA“**

buffet stand  
soporte para buffet  
présentoir buffet



Akazienholz geölt / acacia wood oiled / mader de acacia aceitada / bois d'acacia huilé

	Ø cm	↑ cm
15620	20,0	10,5
15621	30,5	15,0
15622	30,5	20,0

**Frischhalte- Haube / cover / campana / cloche**



	Ø cm	↑ cm	fits to
06520	30	22	15621, 15622

**Frischhalte- Haube / cover / campana / cloche**



	Ø cm	↑ cm	fits to
06512	30	11,5	15621, 15622



**Buffetständer „ACACIA“**

buffet stand  
soporte para buffet  
présentoir buffet



Akazienholz geölt / acacia wood oiled / mader de acacia aceitada / bois d'acacia huilé

	cm	↑ cm	GN
15623	53 x 16,2	20	2/4

**GN Abdeckhaube / GN cover / GN cubierta/ GN cloche**



	cm	↑ cm	GN
11044	53 x 16,2	10,5	2/4

## BUFFET DISPLAY



Die Induktionsstation mit Regler präsentiert sich in einem Set aus Walnussholz, einem schwarzen Metallständer und einer Induktionsheizung.

The induction station with controller is presented in a set of walnut wood, a black metal stand and an induction heater.

La estación de inducción con regulador se presenta en un set formado por una caja de madera de nogal, un soporte de metal negro y un calentador de inducción.

La station à induction avec température réglable se compose d'un caisson en bois noyer, d'un support métallique noir et d'une plaque à induction.



### Induktionsstation, 4-teiliges Set

induction station, 4 pcs.  
estación de inducción, set de 4  
station d'induction, set de 4



#### 4 teiliges Set:

- 1 Induktionskochplatte mit Regler (Ø 24 cm, 900 Watt)
- 1 Metallständer schwarz
- 1 Rahmen aus Walnussholz geölt
- 1 Edelstahlrahmen

#### 4 pcs. set:

- 1 induction hotplate with controller (Ø 24 cm, 900 Watt)
- 1 metal stand black
- 1 frame in oiled walnut wood
- 1 stainless steel frame

#### set de 4:

- 1 placa de inducción con regulador (Ø 24 cm, 900 vatios)
- 1 soporte de metal negro
- 1 caja de madera de nogal aceitada
- 1 marco de acero inoxidable

#### set de 4:

- 1 plaque d'induction avec température réglable (Ø 24 cm, 900 watts)
- 1 support métallique noir
- 1 caisson en bois noyer huilé
- 1 cadre en acier inox

	cm	↑ cm
12270	35,4 x 32,5	19



passendes Chafing Dish Set 12330  
suitable chafing dish set 12330

#### Ersatzteile / replacement parts / piezas de repuesto / pièces de rechange

	cm	↑ cm	
12271	35,4 x 32,5	8,5	Holzrahmen / wooden frame
12272	29,5 x 26,5	1	Edelstahlrahmen / stainless steel frame
12295	Ø 24	-	900 Watt Induktionskochplatte / induction plate
15506	35,4 x 32,5	17,6	Buffetständer schwarz / buffet stand black





jede Schale /  
each bowl  
ca. 2,5 ltr.

**Buffetleiter „BIG“**

buffet ladder  
dispensador en escalera  
présentoir buffet en escalier



12-teiliges Set: 4 Glasschalen Ø 23 cm 2,5 Liter, 4 klappbare Schutzdeckel mit Beschriftungsfenster, 1 Leiter, 1 Doppelring, 2 Einzelringe, einfach und individuell zusammensetzbar

12 pcs. set: 4 glass bowls Ø 23 cm 2.5 litres, 4 hinged covers with card for inscription, 1 ladder, 1 double ring, 2 single rings, easy to fix and individual to use

set de 12: 4 boles vidrio Ø 23 cm 2,5 l, 4 tapas abatibles con ventana para etiqueta, 1 soporte escalera, 1 aro doble, 2 aros sencillos, fácil de montar, posible usar individualmente

set de 12: 4 bols verre Ø 23 cm 2,5 l, 4 couvercles à charnière et fenêtre p/ étiquette, 1 support escalier, 1 cercle double, 2 cercles simples, montage facile, utilisable individuellement

	cm	↑ cm	
11598	39 x 31	66	



jede Schale /  
each bowl  
ca. 2,5 ltr.

**Buffetleiter „BIG“**

buffet ladder  
dispensador en escalera  
Présentoir buffet en escalier



11-teiliges Set: 6 Glasschalen Ø 23 cm 2,5 Liter, 1 Leiter, 2 Doppelringe, 2 Einzelringe, einfach und individuell zusammensetzbar

11 pcs. set: 6 glass bowls Ø 23 cm 2.5 litres, 1 ladder, 2 double rings, 2 single rings, easy and individual to use

set de 11: 6 boles vidrio Ø 23 cm 2,5 l, 1 soporte escalera, 2 aros dobles, 2 aros sencillos, fácil montar, se puede usar individualmente

set de 11: 6 bols verre Ø 23 cm 2,5 l, 1 support escalier, 2 cercles double, 2 cercles simples, montage facile, utilisable individuellement

	cm	↑ cm	
11599	39 x 31	66	

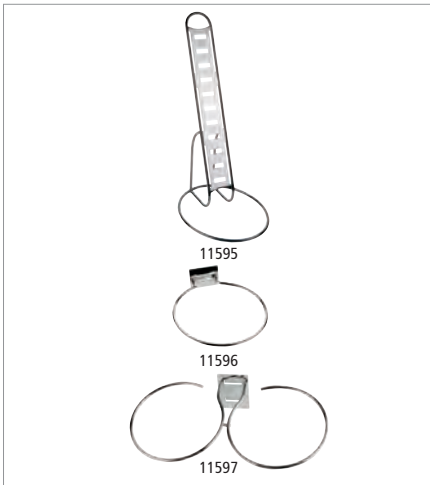

Einzelteile / spare parts / piezas sueltas / pièces détachées

Leitergestell / frame / marco solo en escalera / échelle support

	cm	↑ cm	
11595	39 x 31	66	

Einzelring / single ring / aro sencillo / cercle simple

	Ø cm	
11596	23,5	

Doppelring / double ring / aro doble / cercle double

	cm	
11597	48 x 23,5	



2,5 ltr.

**Schale**

bowl  
cuenco  
bol



	Ø cm	↑ cm	ltr.
11875	23	10,5	2,5



**Schutzdeckel mit Löffelaussparung**

cover  
tapa  
couvercle



	Ø cm	
11878	23,5	

## BUFFET DISPLAY



jede Schale /  
each bowl  
ca. 0,5 ltr.

### Buffetleiter „LITTLE“

buffet ladder  
dispensador en escalera  
présentoir buffet en escalier



12-teiliges Set: 4 Glasschalen Ø 14 cm 0,5 Liter, 4 klappbare Schutzdeckel mit Beschriftungsfenster, 1 Leiter, 1 Doppelring, 2 Einzelringe, einfach und individuell zusammensetzbar

12 pcs. set: 4 glass bowls Ø 14 cm 0.5 litres, 4 hinged covers with card for inscription, 1 ladder, 1 double ring, 2 single rings, easy and individual to use

set de 12: 4 boles vidrio Ø 14 cm 0,5 l, 4 tapas abatibles con ventana para etiqueta, 1 soporte escalera, 1 aro doble, 2 aros sencillos, fácil montaje, se puede usar individualmente

set de 12: 4 bols verre Ø 14 cm 0,5 l, 4 couvercles à charnière et fenêtre p/ étiquette, 1 support escalier, 1 cercle double, 2 cercles simples, montage facile, utilisable individuellement

	cm	↑ cm
11498	30 x 30	48



jede Schale /  
each bowl  
ca. 0,5 ltr.

### Buffetleiter „LITTLE“

buffet ladder  
dispensador en escalera  
Présentoir buffet en escalier



11-teiliges Set: 6 Glasschalen Ø 14 cm 0,5 Liter, 1 Leiter, 2 Doppelringe, 2 Einzelringe, einfach und individuell zusammensetzbar

11 pcs. set: 6 glass bowls Ø 14 cm 0.5 litres, 1 ladder, 2 double rings, 2 single rings, easy and individual to use

set de 11: 6 boles vidrio Ø 14 cm 0,5 l, 1 soporte escalera, 2 aros dobles, 2 aros sencillos, fácil montaje, se puede usar individualmente

set de 11: 6 bols verre Ø 14 cm 0,5 l, 1 support escalier, 1 cercle double, 2 cercles simples, montage facile, utilisable individuellement

	cm	↑ cm
11499	30 x 30	48

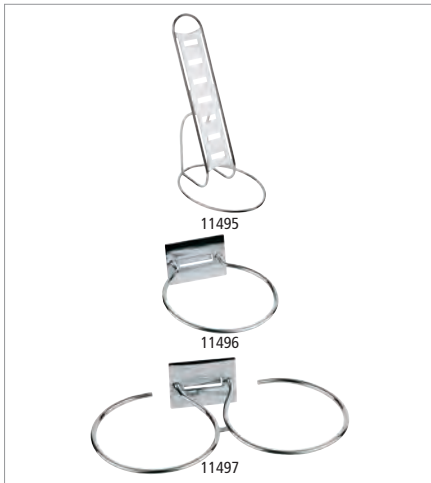

Einzelteile / spare parts / piezas sueltas / pièces détachées

Leitergestell / frame / marco solo en escalera / échelle support

	Ø cm	↑ cm
11495	30	48

Einzelring / single ring / aro sencillo / cercle simple

	Ø cm
11496	14

Doppelring / double ring / aro sencillo / cercle double

	cm	cm
11497	29,5 x 14,5	48



0,5 ltr.

### Schale

bowl  
cuenco  
bol



	Ø cm	↑ cm	ltr.	pcs.
11865	14	6,5	0,5	6



### Schutzdeckel mit Löffelaussparung

cover  
tapa  
couvercle



	Ø cm
11868	14,5



**Buffetgestell „SUNDAY“**

buffet stand  
expositor bufé  
présentoir buffet



**7-teiliges Set: 3 Glasschalen Ø 23 cm (2,5 Liter), 3 klappbare Schutzdeckel, 1 Gestell**

7 pcs. set: 3 glass bowls Ø 23 cm (2,5 litres), 3 hinged covers, 1 stand

set de 7: 3 boles vidrio Ø 23 cm (2,5 l), 3 tapas con bisagra, 1 soporte

set de 7: 3 bols verre Ø 23 cm (2,5 l), 3 couvercles à charnière, 1 support

	cm	↑ cm
11795	61 x 24	35



**Buffetständer „BIG“**

buffet stand  
expositor de buffet  
présentoir buffet



**7-teiliges Set: 3 Glasschalen Ø 23 cm 2,5 Liter, 3 klappbare Schutzdeckel, 1 Ständer**

7 pcs. set: 3 glass bowls Ø 23 cm 2.5 litres, 3 hinged covers, 1 stand

set de 7: 3 boles vidrio Ø 23 cm, 2,5 l, 3 tapas con bisagra, 1 soporte

set de 7: 3 bols verre Ø 23 cm 2,5 l, 3 couvercles à charnière, 1 support

	cm	↑ cm
11892	50 x 50	18



**Buffetständer „LITTLE“**

buffet stand  
expositor de buffet  
présentoir buffet



**7-teiliges Set: 3 Glasschalen Ø 14 cm 0,5 Liter, 3 klappbare Schutzdeckel, 1 Ständer**

7 pcs. set: 3 glass bowls Ø 14 cm 0,5 l, 3 hinged covers, 1 stand

set de 7: 3 boles vidrio Ø 14 cm, 0,5 l, 3 tapas con bisagra, 1 soporte

set de 7: 3 bols verre Ø 14 cm 0,5 l, 3 couvercles à charnière, 1 support

	cm	↑ cm
11893	30 x 30	14

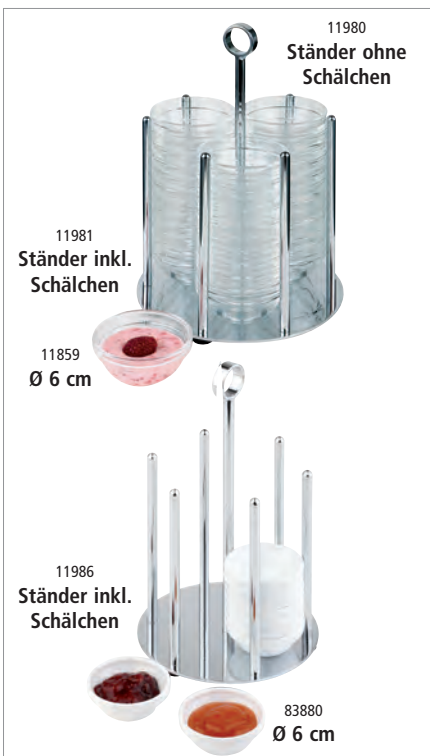

**Schälchenspender „MINI“**

bowl holder  
rack dispensador para bols  
porte-bols



geeignet für Schalen Ø 6 cm, bestückbar mit bis zu 36 Schalen

for bowls Ø 6 cm, suitable for 36 bowls

para bols de Ø 6 cm, apto para 36 bols

pour bols de Ø 6 cm, maxi 36 bols

	Ø cm	↑ cm	
11981	14	25,5	Ständer inkl. 36 Glasschalen, Ø 6 cm frame with 36 bowls, Ø 6 cm
11986	14	25,5	Ständer inkl. 36 Melaminschalen, Ø 6 cm frame with 36 melamine bowls, Ø 6 cm

**Schälchenspender „MINI“ / bowl holder / rack dispensador para bols / porte-bols**

	Ø cm	↑ cm	
11980	14	25,5	Ständer ohne Schalen / frame without bowls soporte sin bols / support sans bols

## BUFFET DISPLAY



passende Gläser / matching glasses  
82310, 82312, 82314

### Serviergestell „WECK“

serving stand  
expositor  
présentoir

ohne Gläser  
without glasses  
sin vasos  
sans verrines



	Ø cm	↑ cm	
33247	22	33	6 x Ø 6 cm



passende Gläser / matching glasses  
82310, 82312, 82314

### Serviergestell „WECK“

serving stand  
expositor  
présentoir

ohne Gläser  
without glasses  
sin vasos  
sans verrines



	Ø cm	↑ cm	
33246	22	59	12 x Ø 6 cm



### Weck-Gläser mit Deckel, 12er Set

Weck-glasses with lid, 12 pcs.  
Weck tarros de vidrio con tapa, set de 12  
Weck verrines avec couvercle, set de 12



12 Gläser + 12 Deckel  
12 glasses + 12 covers  
12 vasos + 12 tapas  
12 verrines + 12 couvercles

	Ø cm	↑ cm	ltr.	pcs
82310	6	5,5	0,08	12
82312	6	7,0	0,14	12
82314	6	8,0	0,16	12



# BUFFET LADDER GN



## Buffetleiter „LITTLE GN 1/3“

buffet ladder  
dispensador en escalera  
présentoir buffet en escalier



4-teilig: 1 Leiter-Gestell, 3 GN 1/3 Rahmen  
4 pcs.: 1 ladder, 3 single rings GN 1/3  
4 pz: 1 soporte escalera, 3 aros sencillos GN 1/3  
4 pc: 1 support escalier, 3 cercles simples GN 1/3

	cm	↑ cm	fits to
11526	31,5 x 32	48	baskets / pans GN 1/3



## Buffetleiter „LITTLE GN 1/2“

buffet ladder  
dispensador en escalera  
présentoir buffet en escalier



4-teilig: 1 Leiter-Gestell, 3 GN 1/2 Rahmen  
4 pcs.: 1 ladder, 3 single rings GN 1/2  
4 pz: 1 soporte escalera, 3 aros sencillos GN 1/2  
4 pc: 1 support escalier, 3 cercles simples GN 1/2

	cm	↑ cm	fits to
11527	31,5 x 41,5	48	baskets / pans GN 1/2

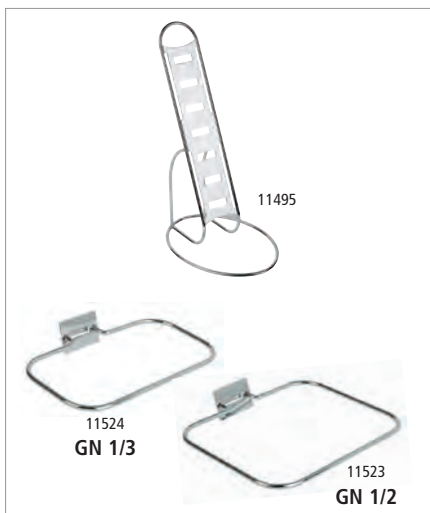

Einzelteile / spare parts / piezas sueltas / pièces détachées

Leitergestell / frame / marco solo en escalera / échelle support

11495

Einzelring GN 1/3 / single ring GN 1/3 / aro sencillo GN 1/3 / cercle simple GN 1/3

11524

Einzelring GN 1/2 / single ring GN 1/2 / aro sencillo GN 1/2 / cercle simple GN 1/2

11523

# BUFFET DISPLAY



2x 84304  
**GN 1/4**  
1x 83757  
**GN 1/2**  
1x 83757  
**GN 1/2**  
1x 83757  
**GN 1/2**

**Buffetleiter „BIG GN 1/2“**  
buffet ladder  
dispensador en escalera  
présentoir buffet en escalier



5-teilig: 1 Leiter-Gestell, 4 GN 1/2 Rahmen  
5 pcs.: 1 ladder, 4 single rings GN 1/2  
5 pz: 1 soporte escalera, 4 aros sencillos GN 1/2  
5 pc: 1 support escalier, 4 cercles simples GN 1/2

	cm	↑ cm	fits to
11528	31,5 x 56	66	baskets / pans GN 1/2



3x 83753  
**GN 1/3**  
2x 83757  
**GN 1/2**  
1x 83759  
**GN 1/1**

**Buffetleiter „BIG GN 1/1“**  
buffet ladder  
dispensador en escalera  
présentoir buffet en escalier



4-teilig: 1 Leiter-Gestell, 3 GN 1/1 Rahmen  
4 pcs.: 1 ladder, 3 single rings GN 1/1  
4 pz: 1 soporte escalera, 3 aros sencillos GN 1/1  
4 pc: 1 support escalier, 3 cercles simples GN 1/1

	cm	↑ cm	fits to
11529	52 x 59	66	baskets / pans GN 1/1

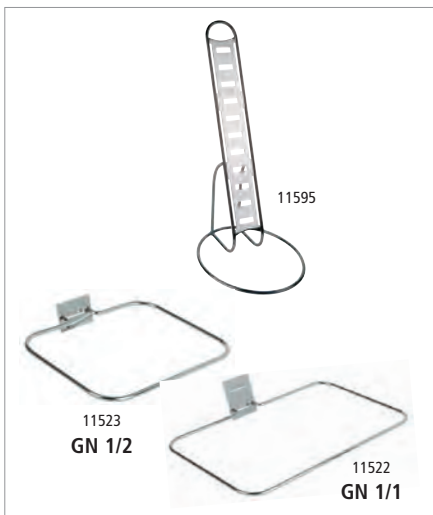

Einzelteile / spare parts / piezas sueltas / pièces détachées

Leitergestell / frame / marco solo en escalera / échelle support

11595

Einzelring GN 1/2 / single ring GN 1/2 / aro sencillo GN 1/2 / cercle simple GN 1/2

11523

Einzelring GN 1/1 / single ring GN 1/1 / aro sencillo GN 1/1 / cercle simple GN 1/1

11522



**Serviergestell „S-PURE“**

serving stand  
soporte buffet  
support buffet



für 3 Tablett quadratisch 83407 oder 83418

for 3 trays square 83407 or 83418

para 3 bandejas cuadradas 83407 o 83418

pour 3 plats carrés 83407 ou 83418

	cm	↑ cm
33226	29 x 17	41



**Serviergestell „M-PURE“**

serving stand  
soporte buffet  
support buffet



für 3 Tablett quadratisch 83406 oder 83407

for 3 trays square 83406 or 83407

para 3 bandejas cuadradas 83406 o 83407

pour 3 plats carrés 83406 o 83407

	cm	↑ cm
33227	33 x 21	44



**Serviergestell „L-PURE“**

serving stand  
soporte buffet  
support buffet



für 3 Tablett rechteckig 83417

for 3 trays rectangular 83417

para 3 bandejas rectangulares 83417

pour 3 plats rectangulaires 83417

	cm	↑ cm
33228	37 x 21	44



**GN Serviergestell „XL-PURE“**

GN serving stand  
GN soporte buffet  
GN support buffet



passend für Tablett GN 1/1, GN 1/2, GN 1/3, GN 2/4

suitable for tray GN 1/1, GN 1/2, GN 1/3, GN 2/4

aptas para bandejas GN 1/1, GN 1/2, GN 1/3, GN 2/4

convient pour les plats GN 1/1, GN 1/2, GN 1/3, GN 2/4

	cm	↑ cm
33222	63 x 27	44,5

## BUFFET DISPLAY



### Buffetgestell „FLOAT SMALL“

buffet stand  
soporte buffet  
support buffet



Metall verchromt, für 3 Schalen Nr. 83916, 83917  
metal chrome plated, for 3 bowls no. 83916, 83917  
metal cromado, para 3 cuencos N° 83916, 83917  
métal chromé, pour 3 coupelles 83916, 83917

	cm	↑ cm
33241	55,5 x 19	15,5

Schale „FLOAT“ / bowl / cuenco / bol

	cm	↑ cm	Farbe / Colour
83916	19 x 19	9,5	White
83917	19 x 19	9,5	Black



### High Tea Rack

High Tea Rack  
rack de te alto  
étagère à thé avec anse supérieure



Holz dunkelbraun, Edelstahlgriff, 4 große Fächer 15 x 10 x 10 cm,  
3 kleine Fächer 9,5 x 9,5 x 10 cm

rubber wood in dark brown, stainless handle, 4 big compartments 15 x 10 x 10 cm, 3 small compartments 9,5 x 9,5 x 10 cm

madera marrón oscura, mango de acero inoxidable, 4 compartimentos grandes 15 x 10 x 10 cm, 3 compartimentos pequeños 9,5 x 9,5 x 10 cm

bois marron foncé, poignée inox, 4 compartiment grand 15 x 10 x 10 cm, 3 compartiment petit 9,5 x 9,5 x 10 cm

	cm	↑ cm
33210	34 x 10	38



### Serviergestell, 2-stufig

serving stand, 2-tier  
soporte platos, 2 alturas  
présentoir, 2 hauteurs



3 tlg. Set: 1 Gestell aus Akazienholz, 2 Schieferplatten, zusammenklappbar

3 pcs.: 1 stand acacia wood, 2 slate tray, foldable

set de 3: 1 soporte madera de acacia, 2 bandeja de pizarra, fácil de plegar

set de 3: 1 présentoir au pour tous les seaux à FRAMES



zusammenklappbar  
foldable

	cm	↑ cm
00958	36,5	34 x 26,5



### Brezel- oder Wurstständer

pretzel-/ sausage stand  
soporte para embutidos  
support à bretzel ou à saucissons



Verkaufsständer Buchen-Holz versiegelt, bestens geeignet für die Präsentation von Brezeln,  
Würstchen, etc., Fuß Ø 22 cm

beech wood, ideal to present pretzels, sausages, etc.

	Ø cm	↑ cm
79553	28	50

Hygieneschutz für Brezelständer / hygienic cover / cubierta higiénica antialiento / pare-haleine

	cm	↑ cm
11557	20 x 20 x 20	50
11558	15 x 20 x 15	50





**2-stufige Etagère**

2-tier tray  
soporte 2 alturas  
étagère 2 niveaux



1 Gestell aus Metall schwarz, mit Antirutschfüßchen,  
2 herausnehmbare Bretter aus geöltem Akazienholz (34,5 x 20,5 x 1,5 cm) / (34,5 x 13 x 1,5 cm)  
8 Beschriftungsschilder (8 x 4 cm)

1 frame made of black metal with non-slip feet,  
2 removable trays made of accacia wood (34,5 x 20,5 x 1,5 cm) / (34,5 x 13 x 1,5 cm)  
8 labelling plates (8 x 4 cm)

1 soporte metálico, negro con pies antideslizantes,  
2 extraíble bandejas extraíbles devmadera de acacia (34,5 x 20,5 x 1,5 cm) / (34,5 x 13 x 1,5 cm)  
8 etiquetas (8 x 4 cm)

1 support métallique noir avec pieds antidérapants,  
2 amovible planches amovibles en bois d' acacia (34,5 x 20,5 x 1,5 cm) / (34,5 x 13 x 1,5 cm)  
8 étiquettes (8 x 4 cm)

	cm	↑ cm
30339	35,5 x 21	40

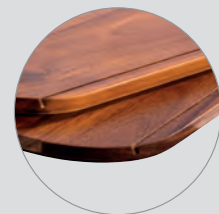
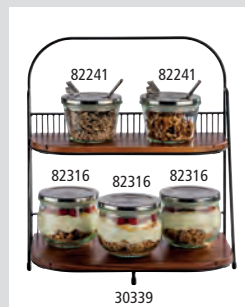

Präsentationsmöglichkeiten mit Antirutsch-Füßchen  
presentation examples with non-slip feet

geöltes Akazienholz  
oiled acacia wood



**2-stufige Etagère „IRON“**

2-tier tray  
bandeja con dos alturas  
étagère carré 2 hauteurs



1 Gestell aus schwarzem Metall  
2 Akazienholzplatten: Ø 23 cm, H: 1,5 cm / Ø 30 cm, H: 2,5 cm  
2 Beschriftungsschilder 15 x 10,5 cm

1 black metal frame  
2 acacia wood panels: Ø 23 cm, H: 1,5 cm / Ø 30 cm, H: 2,5 cm  
2 inscription labels 15 x 10.5 cm

1 soporte metálico negro  
2 tableros de madera de acacia: Ø 23 cm, H: 1,5 cm / Ø 30 cm, H: 2,5 cm  
2 etiqueta de inscripciones 15 x 10,5 cm

1 support métallique noir  
2 panneaux en bois d'acacia: Ø 23 cm, H: 1,5 cm / Ø 30 cm, H: 2,5 cm  
2 étiquette d'inscriptions 15 x 10,5 cm

	cm	↑ cm
30334	47 x 30	44

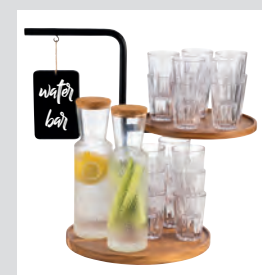
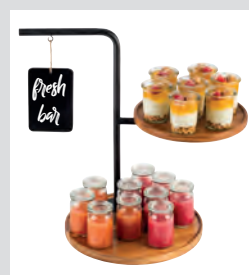

Präsentationsmöglichkeiten  
presentation examples



1 x Gestell / 1 x frame



2 x Korb / 2 x basket

5 tlg.  
5 pcs.



2 x Tablett / 2 x tray



Korb / basket 30337



Tablett / tray 30338

2-stufige Etagère „ALL-ROUNDER“, 5er Set

2-tier tray, 5 pcs.

soporte 2 alturas, set de 5

étagère 2 niveaux, set de 5



5 teiliges Set:

- 1 Gestell aus Metall schwarz, mit Antirutschfüßchen,
- 2 Körbe aus Metall schwarz je 29 x 16 cm, H: 7 cm,
- 2 herausnehmbare Bretter aus geöltem Akazienholz je 28,5 x 15,5 cm, H: 1,5 cm

5 pcs.:

- 1 frame made of black metal with non-slip feet,
- 2 removable baskets of black metal each 29 x 16 cm, H: 7 cm,
- 2 boards of oiled acacia wood each 28,5 x 15,5 cm, H: 1,5 cm

set de 5:

- 1 soporte metálico, negro con pies antideslizantes,
- 2 cestas metálicas negras, cada una de 29 x 16 cm, H: 7 cm,
- 2 tablas de madera de acacia aceitada 28,5 x 15,5 cm, H: 1,5 cm

set de 5:

- 1 support métallique noir avec pieds antidérapants,
- 2 paniers métalliques noirs, chacune 29 x 16 cm, H: 7 cm,
- 2 planches d'acacia huilé, chacune 28,5 x 15,5 cm, H: 1,5 cm

	cm	↑ cm
30336	31 x 17	37,5

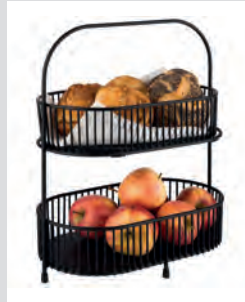

multifunktional,  
ideal als

- Frühstück-Etagère
- Vorspeisen-Etagère
- Kuchen-Etagère
- Brot-Etagère
- Gebäck-Etagère
- Früchte-Etagère

Präsentationsmöglichkeiten  
presentation examples

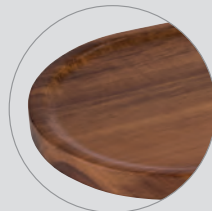

geöltes Akazienholz  
oiled acacia wood

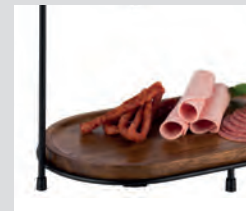

mit Antirutsch-Füßchen  
with non-slip feet

Korb / basket / cesta / corbeille

	cm	↑ cm	Farbe / Colour
30337	29 x 16	7	■

Servierbrett / serving board / tabla de servir / planche de service

	cm	↑ cm	Farbe / Colour
30338	28,5 x 15,5	3,5	■



Serviergestell  
29 x 19,5 cm | H 43 cm  
no. 33220 35,00 €



Serviergestell „INDUSTRIAL“

servicing stand  
soporte platos  
présentoir à assiettes



für Teller max. Ø 27 cm, innerer Ring Ø 18 cm, Lieferung ohne Teller  
for plates max. Ø 27 cm, circle inside Ø 18 cm, delivery without dishes  
para platos máx. Ø 27 cm, aro interior Ø 18 cm, se entrega sin platos  
pour assiettes Ø 27 cm maxi., anneau intérieur Ø 18 cm, livré sans assiettes

	cm	↑ cm	passend für Tellerabdeckhauben / suitable for plate cover	
33208	29 x 19,5	30	2 Teller Ø 27 cm innerer Ring Ø 18 cm	11051, 11052
33209	29 x 19,5	43	3 Teller Ø 27 cm innerer Ring Ø 18 cm	11051, 11052

2-stufige Etagère

2-tier étagère  
cesta doble 2 alturas  
étagère 2 paniers



Griff aus Holz, Körbe aus Metall schwarz,  
oberer Korb (Ø 22 cm, H: 6 cm), unterer Korb (Ø 26 cm, H: 8 cm)  
wooden handle, baskets made of metal black,  
upper basket (Ø 22 cm, H: 6 cm), lower basket (Ø 26 cm, H: 8 cm)  
mango de madera, soporte metálico negro,  
cesta superior (Ø 22 cm, H: 6 cm), cesta inferior (Ø 26 cm, H: 8 cm)  
manche en bois, paniers en métal noir,  
panier supérieur (Ø 22 cm, H: 6 cm), panier inférieur (Ø 26 cm, H: 8 cm)



	Ø cm	↑ cm
30335	26	48



Präsentationsmöglichkeiten  
presentation examples

## ETAGERE

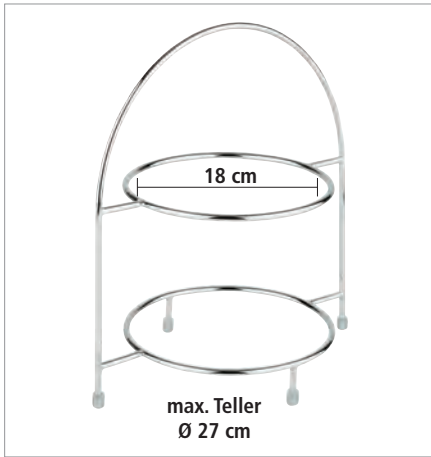

### Serviergestell

serving stand  
soporte platos  
présentoir à assiettes



für 2 Teller max. Ø 27 cm, innerer Ring Ø 18 cm  
for 2 plates max. Ø 27 cm, circle inside Ø 18 cm  
para 2 platos Ø 27 cm, interior aro Ø 18 cm  
pour 2 assiettes maxi Ø 27 cm, cercle Ø int. 18 cm

	cm	↑ cm	Farbe / Colour
33219	29 x 19,5	30	

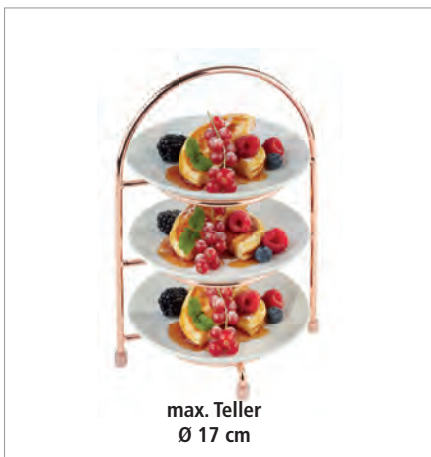

### Serviergestell

serving stand  
soporte platos  
présentoir à assiettes



für 3 Teller max. Ø 17 cm, innerer Ring Ø 10,5 cm  
for 3 plates max. Ø 17 cm, circle inside Ø 10,5 cm  
para 3 platos Ø 17 cm, interior aro Ø 10,5 cm  
pour 3 assiettes maxi Ø 17 cm, cercle Ø int. 10,5 cm

	cm	↑ cm	Farbe / Colour
33215	18,5 x 15,5	26	chrome
33211	18,5 x 15,5	26	copper



### Serviergestell

serving stand  
soporte platos  
présentoir à assiettes



für 3 Teller max. Ø 27 cm, innerer Ring Ø 18 cm  
for 3 plates max. Ø 27 cm, circle inside Ø 18 cm  
para 3 platos Ø 27 cm, interior aro Ø 18 cm  
pour 3 assiettes maxi Ø 27 cm, cercle Ø int. 18 cm

	cm	↑ cm	Farbe / Colour
33220	29 x 19,5	43	chrome
33212	29 x 19,5	43	copper

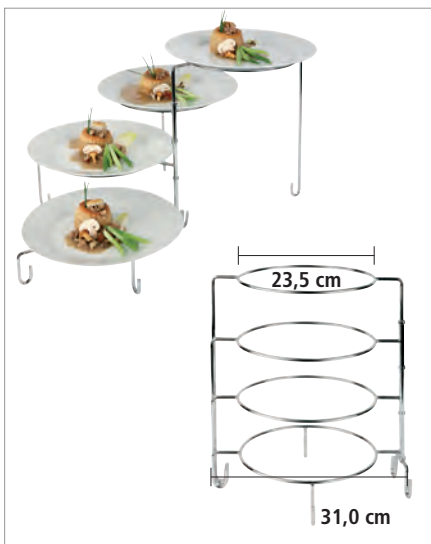

### Serviergestell

serving stand  
soporte platos  
présentoir à assiettes



für 4 Teller (max. Ø 31 cm), platzsparend zusammendrehbar, Lieferung ohne Teller  
for 4 plates (max. Ø 31 cm), can be pushed together for place saving, without dishes  
para 4 platos (max. Ø 31 cm) se puede plegar para ahorrar espacio, se sirve sin platos  
pour 4 assiettes (maxi Ø 31 cm), peut se refermer pour réduire l'encombrement, livré sans assiettes

	Ø cm	↑ cm
33225	34	37



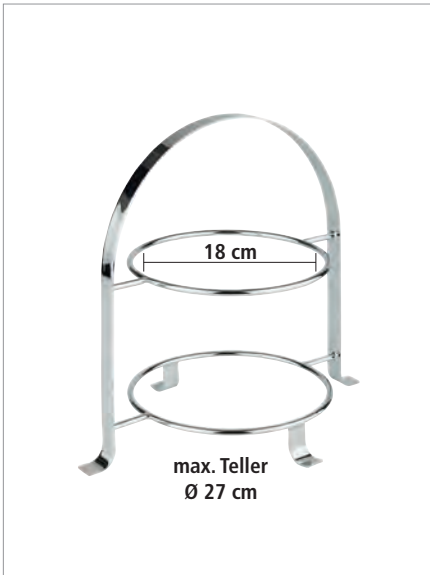

**Serviergestell**

servicing stand  
soporte platos  
présentoir à assiettes



für 2 Teller max. Ø 27 cm, innerer Ring Ø 18 cm, Lieferung ohne Teller  
for 2 plates max. Ø 27 cm, circle inside Ø 18 cm, without dishes  
para 2 platos Ø 27 cm, interior aro Ø 18 cm, se entrega sin platos  
pour 2 assiettes maxi Ø 27 cm, cercle Ø int. 18 cm, livré sans assiettes

	cm	↑ cm
33214	33 x 23,5	30

für 3 Teller max. Ø 27 cm, innerer Ring Ø 18 cm  
for 3 plates max. Ø 27 cm, circle inside Ø 18 cm  
para 3 platos Ø 27 cm, interior aro Ø 18 cm  
pour 3 assiettes maxi Ø 27 cm, cercle Ø int. 18 cm

	cm	↑ cm
33217	33 x 24	43



**Serviergestell**

servicing stand  
soporte platos  
présentoir à assiettes



für 3 Teller max. Ø 17 cm, innerer Ring Ø 10,5 cm  
for 3 plates max. Ø 17 cm, circle inside Ø 10,5 cm  
para 3 platos Ø 17 cm, interior aro Ø 10,5 cm  
pour 3 assiettes maxi Ø 17 cm, cercle Ø int. 10,5 cm

	cm	↑ cm
33216	22,5 x 16,5	25,5



**2-stufige Etagère**

2-tier tray  
bandeja dos alturas  
étagère carré 2 hauteurs



Naturschiefer  
natural slate tray  
bandeja de pizarra natural  
plateau ardoise naturelle

	Ø cm	↑ cm	✦ mm
00989	25 / 20	24	6 - 9



**3-stufige Etagère**

3-tier tray  
bandeja con tres alturas  
étagère carré 3 hauteurs



Naturschieferplatte, Akazienholz  
natural slate tray, wood akazie  
bandeja de pizarra natural, madera de acacia  
plateau ardoise naturelle, bois d'acacia

	Ø cm	↑ cm	✦ mm
00960	30 / 25 / 20	34	6 - 9

## ETAGERE



### Etagère etagère frutero corbeille à fruits

ergonomischer Griff, stehend auf schwarzen Antirutsch-Füßen  
ergonomic handle, anti-slip-feet  
asa ergonómica, pies antideslizantes color negro  
anse ergonomique, pieds antidérapants noirs



	cm	↑ cm
30325	30 x 30	35,5



### Etagère „FINESSE“ etagère frutero étagère

vergoldeter Messing-Kugelgriff, einfache Montage  
gold plated knob, easy to assemble  
botón dorado, fácil de montar  
bouton doré, montage facile



	Ø cm	↑ cm	
33248	48 / 38 / 32	50	3-stufig / 3-tier 3 alturas / 3 niveaux
33238	38 / 32	30	2-stufig / 2-tier 2 alturas / 2 niveaux



### Etagère „CASUAL“ etagère expositor de bombones o bocaditos présentoir à mignardises

inklusive Edelstahl-Schild, beschriftbar  
including sign  
placa incluida, sin inscripción  
étiquette incluse, sans inscription



	Ø cm	↑ cm	
34248	31 - 41 - 51	55	3-stufig / 3-tier 3 niveles / 3 étages



### Serviergestell serving stand expositor présentoir

3-stufig für quadratische Teller / Platten in 3 verschiedenen Größen:  
z.B. 83407 + 83406 + 83405, Lieferung ohne Teller/Platten

3-tier for square dishes / plates in 3 different sizes: e.g. 83407 + 83406 + 83405,  
delivery without dishes / plates

3 alturas para platos cuadrados fuentes en 3 diferentes medidas p.e. 83407 + 83406 + 83405,  
se entrega sin platos/ fuentes

3 niveaux pour assiettes ou plats carrés de différentes dimensions, ex. 83407 + 83406 + 83405,  
livré sans assiettes



	cm	↑ cm
33231	37,5 x 37,5	50

**Teebox**

tea-box  
caja para té  
boîte à thé et infusions



**Holzbox mit Sichtfenster, mit Aufschrift „Tee“, 4 Kammern können mit je 30 kuvertierten Teebeuteln bestückt werden**

wooden box with clear transparent window, with inscription „Tee“, 4 chambers for approx. 30 tea bags each

caja de madera clara con ventana transparente, con inscripción „Tee“, 4 compartimentos, para aproximadamente 30 bolsas de té

en bois clair avec fenêtre, marquée „TEE“, 4 compartiments, pour environ 30 sachets

	cm	↑ cm	Farbe / Colour
11575	33,5 x 20	9	
11574	33,5 x 20	9	

	cm	↑ cm	Farbe / Colour
11576	33,5 x 20	9	ohne Aufschrift / without inscription sin inscpción / sans inscription

**Teebox**

tea-box  
caja para té  
boîte à thé et infusions



**Holzbox mit Sichtfenster, mit Aufschrift „Tee“, 12 Kammern können mit je 12 kuvertierten Teebeuteln bestückt werden**

wooden box with clear transparent window, with inscription „Tee“, 12 chambers for approx. 144 tea bags each

caja de madera clara con ventana transparente, con inscripción „Tee“, 12 compartimentos, para aproximadamente 144 bolsas de té

en bois clair avec fenêtre, marquée „TEE“, 12 compartiments, pour environ 144 sachets

	cm	↑ cm	Farbe / Colour
11775	31 x 28	9	
11776	31 x 28	9	

**Teebox / Multibox**

tea caddy  
caja para té  
boîte à thé et infusions



**3 Fächer für kuvertierte Teebeutel, 1 Fach für Zucker, Kekse, etc., Deckel aufklappbar**

4 chambers

4 compartimentos

4 compartiments

	cm	↑ cm
11563	22 x 17	9

**Sortierbox „MULTI“**

shape sorter  
caja surtida  
boîte de tri



**inklusive 3 herausnehmbare Trennwände, 4 Kammern**

including 3 removable divider, 4 chambers

con 3 divisores extraíbles, 4 compartimentos

avec 3 parois de séparation amovibles, 4 compartiments

	cm	↑ cm	ltr.	Farbe / Colour
84531	31,5 x 17,5	7	2,1	
84532	31,5 x 17,5	7	2,1	

# BUFFET DISPLAY



83615  
Tablett

00954  
Box

00953  
Schneidebrett



## Tablett „BROTSTATION“

tray  
bandeja  
plateau

**Antirutsch-Füßchen**

non-slip feet  
pies antideslizantes  
pieds antiglisse



	cm	↑ cm
83615	59,5 x 35,5	3,5



00953  
Schneidebrett

83615  
Tablett

## Brotschneidebrett „BROTSTATION“

cutting board  
tabla de corte  
planche à découper

**Buchen-Holz**

beech  
haya  
hêtre



	cm	↑ cm
00953	52 x 34	2

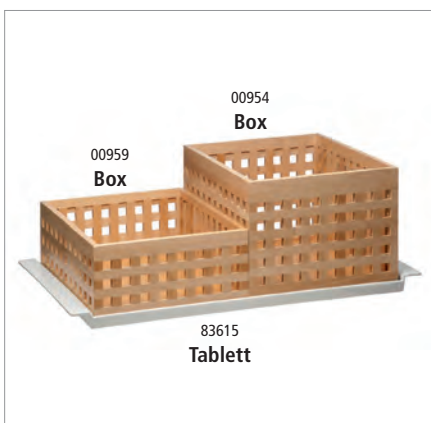

00954  
Box

00959  
Box

83615  
Tablett

## Box „BROTSTATION“

box  
caja de pan para el buffet  
boîte à pain pour le buffet

**Buchen-Holz**

beech  
haya  
hêtre



	cm	↑ cm
00959	34 x 26	12,5
00954	34 x 26	20,0





**Brotschneidebrett „PROFI“**

cutting board  
tabla para cortar  
planche à découper



	cm	↑ cm
00806	58 x 37,5	4



**Brotschneidebrett „LETTER“**

cutting board  
tabla para cortar  
planche à découper



	cm	↑ cm
00886	48 x 34	3,5



**Brotschneidebrett „AKAZIA“**

cutting board  
tabla para cortar  
planche à découper



	cm	↑ cm	GN
00883	47,5 x 32,0	2	
00884	53,0 x 32,5	2	1/1
00885	60,0 x 40,0	2	



praktisches Krümfach  
practical crump shelf



**Brotschneidebrett „RUBBERWOOD“**

cutting board  
tabla para cortar  
planche à découper



	cm	↑ cm	GN
00955	47,5 x 32,0	2	
00956	53,0 x 32,5	2	1/1
00957	60,0 x 40,0	2	



**Brotschneidebrett, 2-teilig**

cutting board, 2 pcs.  
tabla para cortar, set de 2  
planche à découper, set de 2



2-tlg. Set: GN 1/1 Behälter, 20 mm tief, dient als Krümfach  
2 pcs.: GN 1/1 pan 20 mm, bread crump shelf  
set de 2: tabla de corte + bandeja inox GN 1/1 alt 20 mm (sirve para recoger las migas)  
set de 2: planche à découper bois + plateau inox GN 1/1 Ht 20 mm (sert de ramassemies)

	cm	GN
00951	53 x 32,5	1/1

einzelnes Brett / separate board / tabla por separado / planche seule

	cm	GN
00952	53 x 32,5	1/1

# BUFFET GUARD

**3 Höhen einstellbar**  
3 heights adjustable



**schwenkbar**  
swivelling

Servierbeispiel  
presentation example



## Hygieneschutz „BUFFET GUARD“

sneeze guard  
protector anti aliento  
pare-haleine



- transparente, höhenverstellbare Acrylplatte 80 x 53 cm
- Neigungswinkel stufenlos einstellbar
- transparent, height-adjustable acrylic plate 80 x 53 cm
- tilt angle continuously adjustable
- placa acrílica transparente y de altura ajustable 80 x 53 cm
- el ángulo de inclinación es infinitamente variable
- plaque en acrylique transparente 80 x 53 cm et réglable en hauteur
- angle d'inclinaison variable à l'infini

	cm	↑ cm	✱ mm	Fuß / base
98120	93 x 53	50,5	5	Metall schwarz / metal black



Antirutsch-Füßchen  
non-slip feet



Der Neigungswinkel der Acrylplatte ist flexibel einstellbar  
the angle of inclination of the acrylic plate is flexibly adjustable



Höheneinstellung der Acrylplatte in 3 Höhen (20 cm - 30 cm - 40 cm)  
height adjustment of the acrylic plate in 3 steps. (20 cm - 30 cm - 40 cm)



Schalen / bowls 25 x 25 cm  
6 x 83918  
Anwendungsbeispiel  
application example



Lieferung erfolgt demontiert  
delivery takes place disassembled



mit Seitenschutz  
.....▶

Foto: Bäckerei Vielhaber Stockum



**Thekendisplay**  
showcase  
vitrina de mostrador  
vitrine de comptoir



mit Antirutsch-Füßchen, Seitenwände herausnehmbar  
with non-slip feet, removable side panels  
con pies antideslizantes, paneles laterales desmontables  
avec pieds antidérapants, panneaux latéraux amovibles

	cm	↑ cm	fits to
98129	56,0 x 20	21,0	
98130	56,0 x 33	21,0	1 x GN 1/1, 2 x GN 1/2
98131	82,5 x 33	22,5	
98132	102,5 x 33	25,5	3 x GN 1/2



Servierbeispiele  
presentation example





# SPRAY



**Berührungslose Handdesinfektion!**  
touchless hand disinfection!

**Disinfect your hands**

**STOP**

**Informations-  
tafel als  
Wendeschild**  
Information board  
as a turning sign

98250

**Wandversion**  
wall version

**Tischversion**  
table version

98255

98260

**Nicht im Lieferumfang:  
Batterien und Desinfektionsmittel**  
Not included: batteries and disinfectant

## Desinfektionsständer „SPRAY“

disinfection stand  
estación de desinfección  
stand de désinfection



Desinfektionsständer für das kontaktlose Desinfizieren der Hände  
inkl. Informationstafel / Fuß aus schwarzem Metall - standsicher (10 kg)

disinfection stand for contactless disinfection of hands incl. information board /  
heavy stand are made of black metal - very stable (10 kg)

estación de desinfección para la desinfección de las manos sin contacto con letrero de  
información / pie de metal negro - estable (10 kg)

stand de désinfection pour la désinfection des mains sans contact y compris panneau  
d'information / socle en métal noir - stable (10 kg)

	Ø cm	↑ cm	ltr.
98250	32	163	1,0



## Desinfektionsspender „Tischständer“

2 tlg. Set:

- 1 Stk. Desinfektionsspender (no. 98255)
- 1 Stk. Tischständer aus Edelstahl mattiert

## Desinfektionsspender „SPRAY“

disinfectant dispenser  
dispensador de desinfectante  
distributeur de désinfectant



Desinfektionsspender für das kontaktlose Desinfizieren der Hände für die Wandmontage,  
Inhalt ca. 1 Liter, für 6 Stk. Batterien Typ AA (LR6 / 1,5v)

disinfectant dispenser for contactless disinfection of hands for wall mounting  
content approx. 1 liter, for 6 batteries type AA (LR6 / 1,5v)

dispensador de desinfectante para la desinfección sin contacto de las manos, para el montaje en  
la pared, capacidad aproximada de 1 litro, para 6 pilas tipo AA (LR6 / 1,5v)

distributeur de désinfectant pour la désinfection sans contact des mains, pour montage mural,  
capacité d'environ 1 litre, pour 6 piles de type AA (LR6 / 1,5v)

	cm	↑ cm	ltr.
98255	13,5 x 12,5	26	1,0
98260	13,5 x 16,0	47	1,0





**Hygieneschutzwand**

sneeze guard  
protector higiénico  
pare-haleine



**Hygieneschutzwand mit Öffnung**

sneeze guard with opening  
protector higiénico con apertura  
pare-haleine avec ouverture

	cm	↑ cm	Öffnung cm / opening cm	✂ mm
98002	75 x 18	48	25 x 12	3



**Hygieneschutzwand**

sneeze guard  
protector higiénico  
pare-haleine



**Hygieneschutzwand ohne Öffnung**

sneeze guard without opening  
protector higiénico sin apertura  
pare-haleine sans ouverture

	cm	↑ cm	✂ mm
98003	75 x 18	48	3



**Hygieneschutzwand**

sneeze guard  
protector higiénico  
pare-haleine



**Hygieneschutzwand mit Öffnung**

sneeze guard with opening  
protector higiénico con apertura  
pare-haleine avec ouverture

	cm	↑ cm	Öffnung cm / opening cm	✂ mm	Fuß / base
98040	75 x 16,5	57	26 x 13	5	silber matt/ silver matt
98041	75 x 16,5	57	26 x 13	5	schwarz matt/ black matt



**Fuß silber matt**  
base silver matt



**möbelschonende Unterseite**  
non-scratching undersurface



**mit jeweils zwei Schrauben**  
leicht montierbar  
easy mountable with two screws

# DRAWER SET



00910  
3-teiliges Set  
3 pcs. set

50807  
2 x Korb, schwarz



15503  
GN Buffetständer,  
Metall verchromt

15453  
GN 2/3 Tablett

00914  
Schublade mit  
Griff verchromt



00910  
3-teiliges Set  
3 pcs. set



00911  
mit Antirutsch Füßchen  
with non-slip feet



00912

## Schubladen Set, 3-teilig

drawer set, 3 pcs.  
cajonera, set de 3  
set tiroir, set de 3



### 3-teiliges Set:

- 1 Ständer aus Metall schwarz
- 1 Schublade mit Griff schwarz
- 1 Schneidebrett aus geöltem Walnussholz

### 3 pcs. set:

- 1 stand made of metal black
- 1 drawer with handle black
- 1 oiled walnut wood cutting board

### set de 3:

- 1 soporte de metal negra
- 1 cajón con asa negra
- 1 tabla de cortar de madera de nogal engrasada

### set de 3:

- 1 support métallique noire
- 1 tiroir avec poignée noire
- 1 planche à découper en bois de noyer huilé

	cm	↑ cm
00910	35,4 x 32,5	20



15506

00912



00911

## Anwendungsbeispiele application examples

### Einzelteile / parts / piezas / pièces

	cm	↑ cm	
00911	35,4 x 32,5	3,5	Schneidebrett / cutting board
00912	34,0 x 32,0	17,5	Schublade, Griff schwarz / drawer, handle black
00914	34,0 x 32,0	17,5	Schublade, Griff chrom / drawer, handle chrome
15503	35,4 x 32,5	17,6	GN Buffetständer chrom / GN buffet stand chrome
15506	35,4 x 32,5	17,6	GN Buffetständer schwarz / GN buffet stand black



**Vitrine / Thekenaufsatz**

showcase  
vitrina de mostrador  
vitrine de comptoir

rutschfest, aus einem Teil gefertigt  
antislip, monoblock produced  
plástico transparente, fabricado en 1 pieza  
transparente, plastique monoblock (injecté)



	cm	↑ cm
11888	63,5 x 25	25



**Snackpresenter**

snackpresenter  
dispensador de bocadillos  
présentoir à sandwiches

mit Safrille und Griffmulde, passend für Vitrine 11888  
with recessed grip, suitable for showcase 11888  
asa moldeada, apto para la vitrina 11888  
anse moulée, apte pour vitrine 11888



	cm	↑ cm	
11887	29 x 19	6,5	3 Mulden / 3 compartments 3 compartimentos / 3 compartments
11889	60 x 19	7,5	6 Mulden / 6 compartments 6 compartimentos / 6 compartments

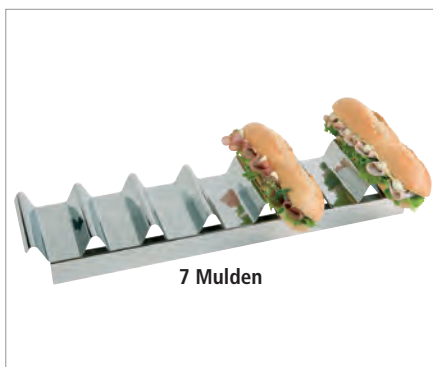

**Snackpresenter**

snackpresenter  
dispensador de bocadillos  
présentoir à sandwiches

hochglanzpoliert, mit Griffmulde, für 7 Baguettes  
mirror polished finish, with recessed grip, for 7 baguettes  
inox pulido brillante, ideal para hasta 7 bocadillos  
inox poli brillant, parfait jusque maxi 7 sandwiches



	cm	↑ cm
11891	47,5 x 10,5	6

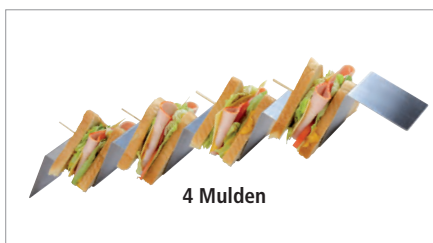

**Snackpresenter**

snackpresenter  
dispensador de bocadillos  
présentoir à sandwiches



	cm	↑ cm
11969	56 x 8	5,5



## BUFFET GUARD · SHOWCASE



**Hygieneschutz**  
hygienic cover  
cubierta higiénica antialiento  
pare-haleine



	cm	↑ cm
11556	82 x 42	45



**Brötchenspender**  
roll dispenser  
dispensador de panecillos  
distributeur de petits pains



hygienisch und einfach zu reinigen, mit Krümelschale  
hygienic and easy to clean, with crumb tray  
higiénico y fácil de limpiar, con bandeja para migas  
hygiénique et facile à laver, avec plat ramasse-miettes

	cm	↑ cm	
11572	32,5 x 27,5	42	für ca. 45 - 50 Brötchen / for approx. 45 - 50 rolls para 45-50 panecillos / pour 45-50 petits pains
11573	32,5 x 27,5	56	für ca. 65 - 70 Brötchen / for approx. 65 - 70 rolls para 65-70 panecillos / pour 65-70 petits pains



**Buffetgestell**  
buffet stand  
soporte para buffet  
présentoir buffet



3-stufig, geeignet für runde und rechteckige Körbe, platzsparend zusammenklappbar  
3-tier, usable for round and rectangular baskets, can be pushed together for place saving  
3 alturas, apto para cestas redondas y rectangulares, se puede plegar para ahorrar espacio  
3 hauteurs, pour corbeilles rondes ou rectang, la structure s'ouvre ou se ferme pour réduire l'encombrement

	cm	↑ cm
33232	59 x 30,5	59

Tisch- und Buffetkorb, rund „ECONOMIC“ / buffet basket, round / cesta de bufé redonda / corbeille de buffet ronde

	Ø cm	↑ cm	Farbe / Colour
40144	39,0	10,0	



**Buffetgestell, 3-teilig**  
buffet stand, 3 pcs.  
expositor de buffet, set de 3  
présentoir buffet, set de 3



3-teilig:  
1. Fach 40 x 40 cm x H 33 cm;  
2. Fach 40 x 37 cm x H 20 cm;  
3. Fach 40 x 34 cm x H 9 cm

3 pcs.:  
1. 40 x 40 cm x H 33 cm;  
2. 40 x 37 cm x H 20 cm;  
3. 40 x 34 cm x H 9 cm

	cm	↑ cm	Farbe / Colour	
11607	40 x 40	33		Wenge





Neigungswinkel stufenlos einstellbar  
inclination angle continuously adjustable

für 3 versch. Haubengrößen  
for 3 different cover sizes

06519 Ø 21 cm  
06520 Ø 30 cm  
06521 Ø 36 cm



Haubenthalterung „FLEXIBLE“

cover holder  
soporte de la cubierta  
support de la cloche



Bei dieser Haubenthalterung wird die Haube am Griff in die Vorrichtung gesteckt.  
Für APS-Hauben geeignet!

With this cover holder, the cover is inserted into the device by the handle.  
Suitable for APS covers!

Con este soporte de campana, la campana se cuelga simplemente por el asa.  
¡Para campanas de APS!

Avec ce support, la cloche s'accroche simplement par la poignée.  
Pour cloches APS!

	cm	↑ cm
33288	35,5 x 30	39



Anwendungsbeispiele  
application examples



Haube | cover  
Ø 16 cm

Tablett | tray  
Ø 18,5 cm

24 cm



Tablett mit Haube

tray with cover  
bandeja con campana  
plateau avec cloche



2 teiliges Set:

- 1 Tablett aus geöltem Buchenholz (Ø 18,5 cm, H: 2,5 cm)
- 1 Glas-Haube (Ø 16 cm, H: 22,5 cm)

2 pcs.:

- 1 tray of oiled beech wood (Ø 18,5 cm, H: 2,5 cm)
- 1 glass cover (Ø 16 cm, H: 22,5 cm)

set de 2:

- 1 bandeja de madera de haya (Ø 18,5 cm, H: 2,5 cm)
- 1 campana de cristal (Ø 16 cm, H: 22,5 cm)

set de 2:

- 1 plateau de bois de hêtre (Ø 18,5 cm, H : 2,5 cm)
- 1 couvercle en verre (Ø 16 cm, H : 22,5 cm)

	Ø cm	↑ cm
00830	18,5	24



Präsentationsmöglichkeit  
presentation example

# MULTI RACK



**Multi Rack**  
multi rack  
dispensador en escalera  
support multiple



**2-stufig, 3-teilig: 1 Gestell matt poliert + 2 Schütten aus transparent gefroretetem Kunststoff, je ca. 1 Liter**

2-tier, 3 pcs.: 1 frame satin polished finish + 2 bowls frosted plastic, approx. 1 liter  
2 alturas - set de 3: 1 soporte inox mate satinado + 2 bols plástico glaseado, aprox. 1 litro  
2 niveaux - set de 3: 1 support satiné + 2 bols plastique mat, approx. 1 litre

	cm	↑ cm
11442	19 x 24	28



**Multi Rack**  
multi rack  
dispensador en escalera  
support multiple



**3-stufig, 4-teilig: 1 Gestell matt poliert + 3 Schütten aus transparent gefroretetem Kunststoff, je ca. 1 Liter**

3-tier, 4 pcs.: 1 frame satin polished finish, + 3 bowls frosted plastic, approx. 1 liter  
3 alturas, set de 4: 1 estructura inox satinado, + 3 bols de plástico glaseado, aprox. 1 litro  
3 niveaux - set de 4: 1 structure inox poli satin, + 3 bols plastique mat, approx. 1 litre

	cm	↑ cm
11444	19 x 24	41



**Multi Rack**  
multi rack  
dispensador en escalera  
support multiple



**3-stufig, 4-teilig: 1 Gestell matt poliert + 1 Schütte aus transparent gefroretetem Kunststoff, ca. 1 Liter + 2 Rutschen aus transparent gefroretetem Kunststoff**

3-tier, 4 pcs.: 1 frame satin polished finish + 1 bowl frosted plastic, approx. 1 liter + 2 slides frosted plastic  
3 alturas, set de 4: 1 soporte inox satinado + 1 bol de plástico glaseado, aprox. 1 litro + 2 bols con „tobogán“ en plástico glaseado  
3 niveaux - set de 4: 1 structure inox poli satin + 1 bol plastique mat approx. 1 litre + 2 bols avec „toboggan“

	cm	↑ cm
11449	19 x 24	41



**Multi Rack**  
multi rack  
dispensador en escalera  
support multiple



**4-stufig, 5-teilig: 1 Gestell matt poliert + 4 Schütten aus transparent gefroretetem Kunststoff, je ca. 1 Liter**

4-tier, 5 pcs.: 1 frame satin polished finish + 4 bowls frosted plastic, approx. 1 liter  
4 alturas, set de 5: 1 estructura inox satinado + 4 bols de plástico glaseado, aprox. 1 litro  
4 niveaux - set de 5: 1 structure inox poli satin, 4 bols plastique mat, approx. 1 litre

	cm	↑ cm
11446	19 x 31	53



**Multi Rack**  
multi rack  
dispensador en escalera  
support multiple



4-stufig, 5-teilig: 1 Gestell matt poliert + 3 Schütten aus transparent gefrostedem Kunststoff, je ca. 1 Liter + 1 Rutsche aus transparent gefrostedem Kunststoff

4-tier, 5 pcs.: 1 frame satin polished finish + 3 bowls frosted plastic, approx. 1 liter + 1 slide frosted plastic

4 alturas, set de 5 piezas: 1 estructura inox satinado + 3 bols de plástico glaseado, aprox. 1 litro + 1 bol con „tobogán“ de plástico efecto glaseado

4 niveaux - set de 5 éléments: 1 structure inox poli satin + 3 bols plastique mat approx. 1 litre + 1 bol avec „toboggan“

	cm	↑ cm	
11451	19 x 31	53	



Schütte

**Ergänzung für alle Multi-Racks**  
supplement for all multi racks  
suplemento para todos los dispensadores  
compléments pour support Multi-Rack



11455	Schütte / canister / bol / bol		
-------	--------------------------------	--	--



Rutsche

**Ergänzung für alle Multi-Racks**  
supplement for all multi racks  
suplemento para todos los dispensadores  
compléments pour support Multi-Rack



11456	Rutsche / slide / tobogan / toboggan		
-------	--------------------------------------	--	--



11466

11467

**Besteckständer „TRIPLE TOWER“**  
cutlery basket  
cesta para cubiertos  
égouttoir á couverts



4-teiliges Set: 1 Gestell + 3 Köcher

4 pcs.: 1 frame + 3 baskets

set de 4: 1 estructura + 3 cubiertos

set de 4: 1 structure + 3 corbeilles

	cm	↑ cm	Farbe / Colour
11466	18 x 26	43	White
11467	18 x 26	43	Black



variable Nutzungsmöglichkeiten  
variable usage possibilities

# SERVICE TOWER



## Service Tower

service tower  
service tower  
tour de service



Präsentations- und Spendersystem, bei minimalen Platzbedarf, optimale Wertschöpfung, zum Beispiel im Bereich der Besteckausgabe, Kaffeestationen, Speiseausgaben, Verkaufstheken, etc., Rückwand aus dunklem Holz oder Acryl gefrostet

Presentation and dispenser system, the products find their best creation of value at minimal need of space, for example in the range of coffeestations, food service, counters etc., backplane made of dark wood or acrylic frosted

sistema de presentación y dispensador, con el mínimo espacio conseguirá una excelente presentación de sus productos, por ejemplo en la zona del café, comidas, etc., trasera de madera oscura o de acrílico opaco mate

système de présentation et distribution, très élégant dans un espace minimum, idéal pour la zone café, coin repas, etc., paroi en bois foncé ou en acrylique mat

	cm	↑ cm	Farbe / Colour	
11431	26 x 18	43	■	2x Schütte, tief + 1x Schütte, flach 2 deep ones + 1 flat one 2 rampas hondas + 1 plana / 2 rampas profundes + 1 plates
11432	26 x 18	43	■	3x Schütte, tief / 3 bowls, deep ones 3 rampas hondas / 3 rampas profundes
11422	26 x 18	57,5	■	4x Schütte, tief / 4 bowls, deep ones 4 rampas hondas / 4 rampas profundes

	cm	↑ cm	Farbe / Colour	
11433	26 x 18	43	■	2x Schütte, tief + 1x Schütte, flach / 2 deep ones + 1 flat one / 2 rampas hondas + 1 plana / 2 rampas profundes + 1 plate
11434	26 x 18	43	■	3x Schütte, tief / 3 bowls, deep ones 3 rampas hondas / 3 rampas profundes
11424	26 x 18	57,5	■	4x Schütte, tief / 4 bowls, deep ones 4 rampas hondas / 4 rampas profundes



## Basisfuss / base / pie de la base / pied de la base

11435

## Rückwand Holz / backplane made of wood / trasera de madera / arrière bois

	cm	
11436	44,5 x 24	für 3 Schütten
11426	60,0 x 24	für 4 Schütten

## Rückwand Acryl / backplane made of acrylic / trasera acrílica / arrière acrylique

	cm	
11437	44,5 x 24	für 3 Schütten
11427	60,0 x 24	für 4 Schütten

## Schütte, tief / bowl, deep / rampa, honda / rampe profonde

	cm	↑ cm
11438	22 x 14	7 / 5

## Schütte, flach / bowl / rampa plana / rampe plate

	cm	↑ cm
11439	22 x 13	3 / 1



# BUFFET STAND



33262

33260

33261



33262

## Buffetständer „STAR“

buffet stand  
soporte para buffet  
présentoire buffet



**Metall, mit schwarzer Antirutschbeschichtung**  
metal, with black anti-slide coating  
metal, con revestimiento antideslizante negro  
métal, avec revêtement antidérapant noir

	↑ cm
33260	8
33261	12
33262	18



33269

## Buffetständer „MULTI ROUND“

buffet stand  
soporte para buffet  
présentoir buffet



**Metall, mit schwarzer Antirutschbeschichtung**  
metal, with black anti-slide coating  
metal, con revestimiento antideslizante negro  
métal, avec revêtement antidérapant noir

	Ø cm	↑ cm
33269	15,5 / 18	8
33270	15,5 / 18	10
33271	15,5 / 18	18

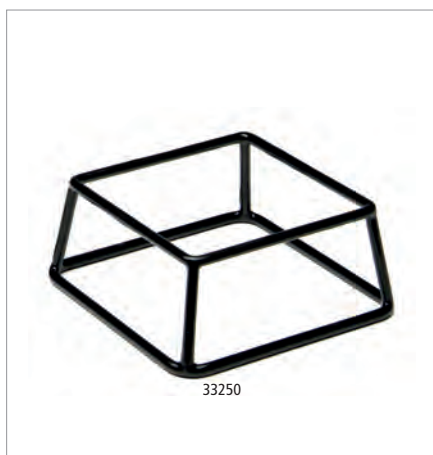

33250

## Buffetständer „MULTI“

buffet stand  
soporte para buffet  
présentoir buffet



**Metall, mit schwarzer Antirutschbeschichtung**  
metal, with black anti-slide coating  
metal, con revestimiento antideslizante negro  
métal, avec revêtement antidérapant noir

	cm	↑ cm
33249	18 x 18	5
33250	18 x 18	8
33251	18 x 18	10
33252	18 x 18	18

# BUFFET STAND



Präsentationsmöglichkeiten /  
presentation examples



variable Nutzungsmöglichkeiten /  
variable usage possibilities

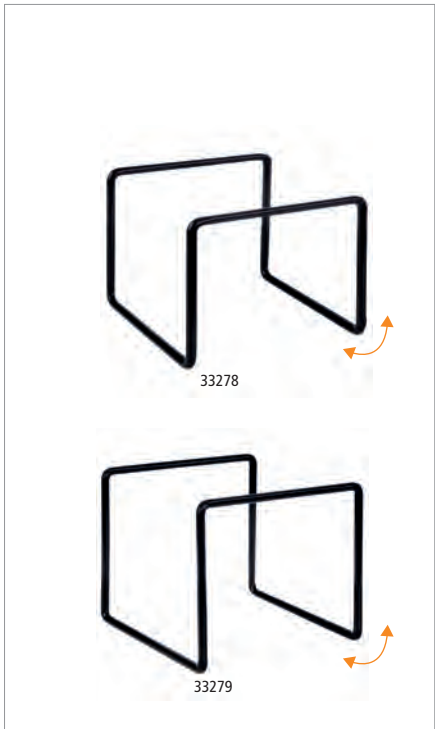

## Buffetständer

buffet stand  
soporte para buffet  
présentoir buffet



### Buffetständer aus Metall mit Antirutschbeschichtung

buffet stand made of metal with non-slip coating  
soporte para buffet de metal con revestimiento antideslizante  
présentoir buffet en métal avec revêtement antidérapant

	cm	↑ cm
33278	11,5 x 11,5	9,0
33279	16,5 x 16,5	14,5

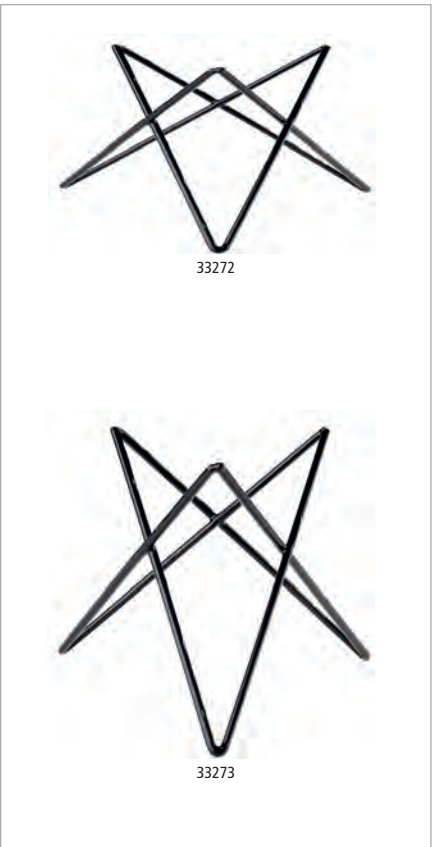

## Buffetständer „PRISMA“

buffet stand  
soporte para buffet  
présentoir buffet



### Metall, mit schwarzer Antirutschbeschichtung

metal, with black anti-slide coating  
metal, con revestimiento antideslizante negro  
métal, avec revêtement antidérapant noir

	Ø cm	↑ cm
33272	20	10,5
33273	20	20,0



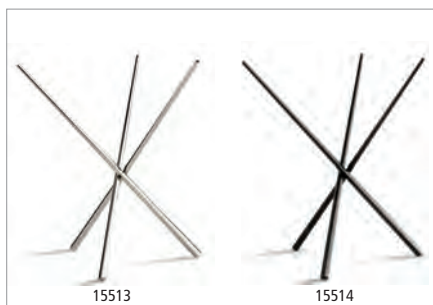

**Buffetständer „ASIA PLUS“**

buffet stand  
soporte para buffet  
présentoir buffet



	∅ cm	↑ cm	Farbe / Colour
15513	20,5 / 16,5	20	Light Wood
15514	20,5 / 16,5	20	Dark Wood



**Buffetständer „KING“**

buffet stand  
soporte para buffet  
présentoir buffet



kein Verrutschen, Arme und Boden sind mit Antirutschflächen ausgestattet, schwere standsichere Qualität, Fuß dient als Löffelablage  
the arms and base are equipped with non-slip surfaces, stable quality, base serves as spoon holder  
anti-deslizante: revestimiento antideslizante en las puntas de los brazos y en la base, estable y alta calidad, la base sirve como reposacuchara  
antiglisse: revêtement antidérapant sur les extrémités des 3 pieds et sur la base, robuste, stable et bonne qualité, la base sert de support pour les couverts

	∅ cm	↑ cm
03622	15	14
03623	15	21



**Buffetständer „WOOD“**

buffet stand  
soporte para buffet  
présentoir buffet



Akazienholz, liegend oder stehend, variable Nutzungsmöglichkeiten  
acacia wood, usable by lying or standing, there are many possibilities to use  
madera de acacia, se puede usar tumbado o de pie, hay diferentes opciones de utilizar  
bois d'accacia, il y a différentes possibilités d'usage

	cm	↑ cm	Farbe / Colour
33280	20 x 20	17,5	Light Wood
33281	20 x 20	17,5	Dark Wood



liegend oder stehend, variable Nutzungsmöglichkeiten  
vertically or horizontally, there are variable usage possibilities



**Buffetständer**

buffet stand  
expositor de buffet  
présentoir buffet



Akazienholz  
acacia wood  
madera de acacia  
bois d'accacia

	∅ cm	↑ cm
33255	15	10
33256	25	15

# PROFI LINE



## GN Edelstahl-Tablett „PROFI LINE“

GN tray  
GN bandeja  
GN plat empilable système catering



	cm	↑ cm	GN	
11100	53,0 x 32,5	1,5	1/1	mit glattem Rand / without decor-edge sin borde decorado / bords lisses
12100	32,5 x 26,5	1,5	1/2	mit glattem Rand / without decor-edge sin borde decorado / bords lisses
11000	53,0 x 32,5	1,5	1/1	mit Dekor-Rand / with decor-edge con borde decorado / bords avec relief
12000	32,5 x 26,5	1,5	1/2	mit Dekor-Rand / with decor-edge con borde decorado / bords avec relief
11110	53,0 x 32,5	1,0	1/1	glatter schmaler Rand / smooth narrow edge / borde estrecho liso / bord étroit lisse



## Fleisch- und Gemüseplatte „PROFI LINE“

tray  
fuente de servicio  
plat de service

Dekorrand hochglanzpoliert  
decor edge mirror polished finish  
borde decorado pulido efecto espejo  
contour relief avec effet miroir



	Ø cm	↑ cm
11032	32	2,5
11038	38	2,5
11048	48	2,5





**GN Edelstahl-Behälter „PROFI LINE“**

GN pan  
GN cubeta  
GN bac



	cm	↑ cm	GN	ltr.
11020	53,0 x 32,5	2,0	1/1	1,7
11040	53,0 x 32,5	4,0	1/1	3,4
11065	53,0 x 32,5	6,5	1/1	7,0
12065	32,5 x 26,5	6,5	1/2	3,3



Distanzstücke erhöhen die Nutzhöhe auf 4 cm

**GN 1/1 System-Tablett „PROFI LINE“**

GN 1/1 tray  
GN 1/1 bandeja  
GN 1/1 plateau



Dekorrand hochglanzpoliert, massive Griffe verchromt, inkl. fest verschraubten Distanzstücken, Nutzhöhe 4 cm  
decor edge mirror polished finish, chrome plated handles, incl. mounted 4 cm distance pillars

borde decorado pulido brillante, asas cromadas, incl. distanciadores atornillados, con profundidad efectiva de 4 cm

bord avec reliefs poli miroir, poignées chromées, incl. distance bien fixée avec hauteur utile de 4 cm

	cm	GN
11300	53 x 32,5	1/1



Distanzstücke erhöhen die Nutzhöhe auf 4 cm

**GN 1/1 System-Tablett „PROFI LINE“**

GN 1/1 tray  
GN 1/1 bandeja  
GN 1/1 plateau



Rand hochglanzpoliert, massive Bügelgriffe vergoldet, inkl. fest verschraubten Distanzstücken, Nutzhöhe 4 cm

mirror polished finish edge, gold plated handles, stackable approx. 4 cm

borde pulido brillante, asas doradas, incl. distanciadores atornillados, con profundidad efectiva de 4 cm

bord poli miroir, poignées dorées, incl. distance bien fixée avec hauteur utile de 4 cm

	cm	GN
11290	53 x 32,5	1/1



11150  
mit verchromten Griffen

11155  
mit vergoldeten Griffen

**GN 1/1 System-Tablett „BUFFET-STAR“**

GN 1/1 tray  
GN 1/1 bandeja  
GN 1/1 plateau



Rand hochglanzpoliert, inkl. fest verschraubten Griffen inkl. Distanzstücken, Nutzhöhe 4 cm  
mirror polished finish edge, incl. screwed handles incl. distance pillars, 4 cm distance

borde pulido brillante, incl. asas atornillables, incl. distanciadores con profundidad efectiva de 4 cm

bord poli miroir, incl. poignées à visser, incl. distance avec hauteur utile de 4 cm

	cm	GN	
11150	53 x 32,5	1/1	mit verchromten Griffen / with chrome plated handles / con asas cromadas / avec poignées chromées
11155	53 x 32,5	1/1	mit vergoldeten Griffen / with gold plated handles / con asas doradas / avec poignées dorées

## TRAY · BOARD



### System-Tablett „BUFFET-STAR“

system tray  
bandeja del sistema  
plat empilable système catering



Rand hochglanzpoliert, inkl. fest verschraubten Griffen inkl. Distanzstücken, Nutzhöhe 4 cm  
mirror polished finish edge, incl. screwed handles incl. distance pillars, 4 cm distance  
borde pulido efecto espejo, incluye asas atornillables, distanciadores a 4 cm  
contour effet miroir, poignées à visser, distance approx. 4 cm

	Ø cm	
11160	48	mit verchromten Griffen / with chrome handles
11165	48	mit vergoldeten Griffen / gold plated handles

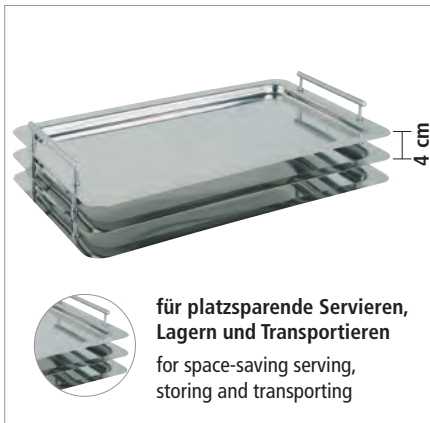

### GN 1/1 System-Tablett „CLASSIC“

GN tray  
GN bandeja  
GN plat empilable système catering



Rand hochglanzpoliert, mit fest verschraubten Griffen inkl. Distanzstücken, Nutzhöhe 4 cm  
mirror polished finish edge, incl. screwed handles incl. distance pillars, 4 cm distance  
borde pulido efecto espejo, incluye asas atornillables, distanciadores a 4 cm  
contour effet miroir, poignées à visser, distance approx. 4 cm

	cm	GN
11295	53 x 32,5	1/1



### Tablett „SWING“

tray  
bandeja  
plateau



Rand matt poliert, innen hochglanzpoliert  
satin polished finish edge, inside mirror polished finish  
borde pulido efecto satinado, interior pulido efecto espejo  
contour effet mat, intérieur poli miroir

	cm	↑ cm	GN
01415	28,5 x 20,0	1	
01416	32,5 x 32,5	1	
01420	53,0 x 32,5	1	1/1



### Tablett „SUNDAY“

tray  
bandeja  
plateau



hochglanzpoliert  
mirror polished finish  
acabado espejo pulido  
effet brillant

	cm	↑ cm	GN
11210	32,5 x 26,5	2	1/2
11220	53,0 x 32,5	2	1/1



11195  
2-tlg. Set Tablett + Haube

stapel- und  
fixierbar

**GN 1/1 Buffet-Set „CATERER“**

GN 1/1 buffet set  
GN 1/1 set de bufé  
GN 1/1 set catering: plateau + cloche



2-teilig: Tablett + Haube, Tablett fixiert sich auf der Haube - kein Rutschen möglich  
2 pcs. set: tray + cover, tray fixes itself on the cover and can not slip off  
set de 2: bandeja + tapa, la bandeja encaja encima de la tapa para que no se deslice  
set de 2: plateau GN 1/1 réf. + cloche spéciale empilement stable

	cm	↑ cm	GN
11195	53 x 32,5	10,5	1/1



11302  
GN 1/1, 2-tlg. Set Tablett + Haube

**GN 1/1 Buffet-Set „HOCHSTAPLER“**

GN 1/1 buffet set  
GN 1/1 set de bufé  
GN 1/1 kit catering plateau + cloche



2-teilig: Tablett + Haube, Tablett fixiert sich auf der Haube - kein Rutschen möglich  
2 pcs. set: tray + cover, tray fixes itself on the cover and can not slip off  
set de 2: bandeja + tapa, la bandeja encaja encima de la tapa para que no se deslice  
set de 2: plateau GN 1/1 réf. + cloche spéciale empilement stable

	cm	↑ cm	GN
11302	53 x 32,5	10,5	1/1



11305  
Haube / cover

11300  
Tablett / tray

Haube für stapelbare Tablett:  
11300, 11290 oder 11295

**GN 1/1 Haube „HOCHSTAPLER“**

GN 1/1 cover  
GN 1/1 campana  
GN 1/1 cloche



glasklarer Kunststoff, Tablett fixiert sich auf der Haube - kein Rutschen möglich, nahezu bruchfest  
clear plastic, tray fixes itself on the cover and can not slip off, nearly unbreakable  
plástico transparente, la bandeja se fija a la tapa para que no se deslice, muy resistente a la rotura  
en plastique transparen, le plat se fixe sur le dessous de la cloche pour ne pas glisser, très résistant à la casse

	cm	↑ cm	fits to	GN
11305	53 x 32,5	9	11300, 11290, 11295	1/1



**GN Abdeckhaube**

GN cover  
GN cubierta  
GN cloche



	cm	↑ cm	✱ mm	GN
11041	32,5 x 26,5	9,5	3	1/2
11042	53,0 x 32,5	9,5	3	1/1
11043	32,5 x 17,6	10,5	3	1/3
11044	53,0 x 16,2	10,5	3	2/4

## TRAY · BOARD



### Tablett „SCHÖNER ESSEN“

tray  
bandeja  
plateau



	cm	GN
00383	35,0 x 24,0	
00382	42,0 x 31,0	
00381	50,0 x 36,0	
00384	63,5 x 44,5	
00385	60,0 x 40,0	
00388	53,0 x 32,5	1/1

	cm	
03824	42,0 x 31,0	leichte Ausführung 0,5 mm / extra light model 0,5 mm modelo extraligero 0,5 mm / qualité légère, ép. 0,5 mm



### Tablett „SCHÖNER ESSEN“

tray  
bandeja  
plateau



mit Dekorrand, Griffe Zinkdruckguss verchromt, genietet  
with decor edge, handles zinc alloy chrome plated, riveted  
borde decorado, asas fundición con zinc  
bord décor, poignées en fonte zinguée

	cm
00082	52 x 31,0
00081	60 x 36,0
00084	75 x 44,5



### Tablett „SCHÖNER ESSEN“

tray  
bandeja  
plateau



	cm	
00087	38 x 23	rechteckig, abgerundet / rectangular, rounded edge rectangular / rectangulaire



### Edelstahl-Schale

bowl  
bandeja  
corbeille



ingerollter Rand  
rolled edge  
borde redondeado  
bord roulé

	cm	↑ cm
40110	26,5 x 18,5	4,0
40115	31,0 x 21,0	4,5





00075

**Tablett „SCHÖNER ESSEN“**

tray  
bandeja  
plateau



	Ø cm
00075	31
00085	35



**Tablett mit Haube „SCHÖNER ESSEN“**

tray with cover  
bandeja con cubierta  
plateau avec cloche



	cm	↑ cm
38202	42 x 31	8

Haube / cover / campana / cloche

	cm	↑ cm
08201	36,5 x 26,0	7,5



**Tablett**

tray  
bandeja  
plateau



mit gebördeltem, polierten Rand  
rolled and mirror polished edge  
borde redondeado acabado efecto espejo  
bord rond, effet miroir

	Ø cm	↑ cm
01336	35	3



01336

74207

**Buffetständer**

buffet stand  
soporte buffet  
support buffet



	Ø cm	↑ cm	fits to
74207	20 - 25	19	01336



Ø 19 cm - Ø 28 cm - Ø 40 cm

60270

**Servierpfanne**

pan  
fuente para la mesa  
plat pour la table



mit vergoldeten Edelstahl-Griffen, 1 mm dick  
with gold plated handles, 1 mm thickness  
grosor 1 mm., asas doradas  
épaisseur 1 mm, poignées dorées

	cm	↑ cm	ltr.
61190	19	3,5	0,7
61280	28	4,0	2,0
61400	40	5,0	4,5
60270	26,5 x 19,5	3	0,8
60310	31,0 x 21,5	3	1,2

## TRAY · BOARD



### Tablett „FINESSE“

tray  
bandeja  
plateau



	cm
01314	30 x 24
01313	35 x 24
01317	39 x 26
01312	42 x 31
01318	48 x 30
01311	50 x 38
01310	58 x 42
01309	68 x 48



### Tablett „FINESSE“

tray  
bandeja  
plateau



	Ø cm
01332	32,0
01335	35,0
01338	38,0
01348	48,0
01349	48,5
01358	58,0



### Tablett „FINESSE“

tray  
bandeja  
plateau



	cm
01322	42 x 30
01323	50 x 36
01324	60 x 41
01325	70 x 46



### Tablett „FINESSE“

tray  
bandeja  
plateau



verchromte Messing-Griffe  
chrome plated brass handles  
asas plateadas de latón  
poignées en laiton chromées

	Ø cm
01738	38
01748	48



**Tablett „FINESSE“**

tray  
bandeja  
plateau

verchromte Messing-Griffe  
chrome plated brass handles  
asas de latón cromadas  
poignées en laiton chromées



	cm	
01712	44 x 31	
01711	52 x 38	
01710	60 x 42	
01709	70 x 48	



**Tablett mit Haube „FINESSE“**

tray with cover  
bandeja con campana  
plateau avec cloche



	cm	
13122	42 x 31	8,5



**Tablett mit Haube „FINESSE“**

tray with cover  
bandeja con campana  
plateau avec cloche



	Ø cm	↑ cm
13622	22	9,5



**Tablett mit Haube „FINESSE“**

tray with cover  
bandeja con cubierta  
plateau avec cloche



	Ø cm	↑ cm	Ø cm Hauben / cover
13382	38	12	30
13385	38	13	33



**Edelstahltablett**

tray  
bandeja  
plateau



	cm	
09010	43,5 x 32,5	1,5

**Rolltophaube „FOCUS“ / rolltop cover / campana abatible / cloche basculante**

	cm	
09013	44 x 33,5	17



**Tablett mit Haube, 2-teilig**

tray with cover, 2 pcs.  
bandeja con cubierta, set de 2  
plateau avec cloche, set de 2

**Tablett aus Edelstahl, hochglanzpoliert**  
stainless steel tray, mirror polished finish  
bandeja de acero inoxidable, acabado brillante  
plateau en acier inoxydable, brillant



	Ø cm	↑ cm
00827	27	12,5

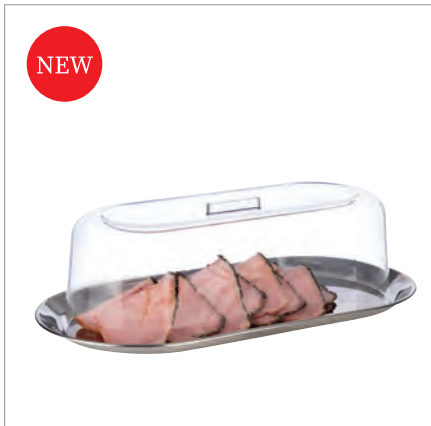

**Tablett mit Haube, 2-teilig**

tray with cover, 2 pcs.  
bandeja con cubierta, set de 2  
plateau avec cloche, set de 2

**Tablett aus Edelstahl, hochglanzpoliert**  
stainless steel tray, mirror polished finish  
bandeja de acero inoxidable, acabado brillante  
plateau en acier inoxydable, brillant



	cm	↑ cm
00828	30 x 15,5	10,5



**Serviertöpfchen**

small serving pot  
olla pequeña de servir  
marmite petite de servir

**gehämmerte Oberfläche**  
hammered surface  
superficie martillada  
surface martelée



	Ø cm	↑ cm	ltr.	Griff / handle cm
40186	9,5	5,5	0,30	2,5
40187	13,5	5,0	0,55	3,0
40188	15,5	5,0	0,75	3,0



**Kaviarkühler**

caviar cooler  
enfriador de caviar  
rafraîchisseur de caviar

**4-teilig: 1 Edelstahlschale, 1 Halter, 1 Glashalm, 1 Edelstahldeckel**

4 pcs.: 1 stainless steel bowl, 1 holder, 1 glass bowl Ø 10 cm, 1 stainless steel cover

set de 4: 1 bol de acero inoxidable, 1 soporte, 1 bol de vidrio Ø 10 cm, 1 tapa de acero inoxidable

set de 4: 1 bol en acier inox, 1 support, 1 bol en verre Ø 10 cm, couvercle en acierinox



	Ø cm	↑ cm
01699	18	12





Tablett „ELEGANCE“

tray  
bandeja  
plateau



	cm
02310	41 x 26
02311	48 x 30
02312	60 x 37



Tablett mit Haube „ELEGANCE“

tray with cover  
bandeja con cubierta  
plateau avec cloche



	cm	↑ cm
23642	35 x 19	10



Serviertablett mit Haube

tray  
bandeja  
plateau



	cm	↑ cm
00064	33 x 17	10
00067	25 x 19	7

Haube für 00064 / cover for 00064 / campana para 00064 / cloche pour 00064

06401

Haube für 00067 / cover for 00067 / campana para 00067 / cloche pour 00067

06701

## TRAY · BOARD



### Tortenplatte mit Haube

cake plate with cover  
bandeja tarta con campana  
plat à tarte avec cloche



	Ø cm	↑ cm	
00065	30	11	mit 1 Haube / with 1 cover
00652	30	7 + 11	mit 2 Hauben / with 2 cover



### Tortenplatte „BAROCK“

cake plate  
bandeja tartas  
plat à gâteau



**2-teilig: Tortenplatte mit Barock-Rand + Haube (extra stabil)**  
2 pcs.: cake plate with decor edge „Barok“ + cover (extra robust)  
set de 2: porta tartas, borde decor „Barok“ + campana (extra fuerte)  
set de 2: plateau bord décor „Barok“ + cloche ultra-résistante

	Ø cm	↑ cm
06503	32	10

#### Frischhalte-Haube / cover / campana / cloche

	Ø cm	↑ cm
06510	30	11,5



### Käseglocken-Set „BRAZIL“

rolltop set  
set rolltop  
set cloche á fromage



**3-teilig: Tablett + Holzschneidebrett + Rolltophaube glasklar, rutschfeste Haubenfixierung**  
3 pcs. set: tray + wooden board + rolltop cover, cover non-slip fixed  
set de 3: bandeja + tablero de madera + campana abatible, fijación antideslizante  
set de 3: plateau + planche à découper + cloche abattante, fixation antiglisse

	Ø cm	↑ cm
09085	45	24



### Rolltop-Set

rolltop set  
set rolltop  
set cloche à fromage



**2-teilig: Tablett + Rolltophaube glasklar, rutschfeste Haubenfixierung, klappbar**  
2 pcs.: tray + rolltop cover, cover non-slip fixed, mountable  
set de 2: bandeja + campana abatible fijación antideslizante, montable  
set de 2: plateau + cloche abattante, fixation antiglisse, montable

	Ø cm	↑ cm
09080	38	24
09099	50	28



### Rolltop-Set

rolltop set  
set rolltop  
set rolltop



2-teilig: Schneidbrett marmoriert + Rolltophaube glasklar,  
rutschfeste Haubenfixierung, klappbar

2 pcs.: plastic board + rolltop cover, cover non-slip fixed, mountable  
set de 2: tablero de plástico + tapa abatible, tapa antideslizante, montable  
set de 2: planche à découper + cloche abattante, fixation antiglisse, montable

	Ø cm	↑ cm
09081	38	24



### Rolltop-Set, 3-teilig

rolltop set, 3 pcs.  
rolltop, set de 3  
rolltop, set de 3



1 Edelstahltablett Ø 38 cm + 1 Naturschieferplatte Ø 33 cm + 1 Rolltophaube Ø 38 cm

1 stainless tray Ø 38 cm + 1 natural slate tray Ø 33 cm + 1 rolltop cover Ø 38 cm  
1 bandeja de acero inoxidable Ø 38 cm + 1 bandeja de pizarra natural Ø 33 cm + 1 tapa abatible Ø 38 cm  
1 plat inox 38 cm + 1 plat ardoise naturelle 33 cm + 1 cloche 38 cm

	Ø cm	↑ cm
01000	38	24



### Buffet-Set

buffet set  
set de bufé  
présentoir pour le buffet



2-teilig: Platte + Rolltophaube, schneidfeste und porenfreie Oberfläche, rutschfeste Haubenfixierung, Platte mit rutschfesten Füßen

2 pcs.: glass board + rolltop cover, scratch-resistant surface, cover non-slip fixed, non-slip feet  
set de 2 piezas: bandeja vidrio redonda + campana abatible, fijación antideslizante, pies antideslizantes

set de 2 pièces: plateau verre rond + cloche abattante, fixation antiglisse et pieds antidérapants

	Ø cm	↑ cm
00978	38	23

Rolltop-Haube mit Löchern / rolltop cover / campana abatible / cloche basculante

	Ø cm	↑ cm
18394	38	20

Glasplatte / glass plate / bandeja de vidrio / plateau verre

	Ø cm	↑ cm
00972	38	3



### Tablett mit Haube

tray with cover  
bandeja con campana  
plateau avec cloche

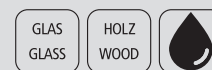

2 teiliges Set:

- 1 Tablett aus geöltem Buchenholz (Ø 18,5 cm, H: 2,5 cm)
- 1 Glas-Haube (Ø 16 cm, H: 22,5 cm)

2 pcs.:

- 1 tray of oiled beech wood (Ø 18,5 cm, H: 2,5 cm)
- 1 glass cover (Ø 16 cm, H: 22,5 cm)

	Ø cm	↑ cm
00830	18,5	24



NEW

**Tablett mit Haube, 2 teilig**

tray with cover, 2 pcs.  
bandeja con cubierta, set de 2  
plateau avec cloche, set de 2



**Tablett aus Bambus, ölimprägniert und feuchtigkeitsabweisend**  
bamboo tray, oil-impregnated and moisture-repellent  
bandeja de bambú, impregnada de aceite y repelente a la humedad  
plateau en bambou, imprégné d'huile et résistant à l'humidité

cm                      ↑ cm  
00820                  24 x 18,5                  8



NEW

**Kastenkuchen-Größe**  
box-cake size

**Tablett mit Haube, 2 teilig**

tray with cover, 2 pcs.  
bandeja con cubierta, set de 2  
plateau avec cloche, set de 2



**Tablett aus Bambus, ölimprägniert und feuchtigkeitsabweisend**  
bamboo tray, oil-impregnated and moisture-repellent  
bandeja de bambú, impregnada de aceite y repelente a la humedad  
plateau en bambou, imprégné d'huile et résistant à l'humidité

cm                      ↑ cm  
00821                  32 x 16,5                  11



NEW

**Tablett mit Haube, 2 teilig**

tray with cover, 2 pcs.  
bandeja con cubierta, set de 2  
plateau avec cloche, set de 2



**Tablett aus Bambus, ölimprägniert und feuchtigkeitsabweisend**  
bamboo tray, oil-impregnated and moisture-repellent  
bandeja de bambú, impregnada de aceite y repelente a la humedad  
plateau en bambou, imprégné d'huile et résistant à l'humidité

Ø cm                      ↑ cm  
00822                  20,5                  10



NEW

**Tablett mit Haube, 2-teilig**

tray with cover, 2 pcs.  
bandeja con cubierta, set de 2  
plateau avec cloche, set de 2



**Tablett aus Holz, ölimprägniert und feuchtigkeitsabweisend, Gugelhupf Größe**  
wooden tray, oil-impregnated and moisture-repellent, Gugelhupf size  
bandeja de madera, impregnada de aceite y repelente a la humedad, tamaño Gugelhupf  
plateau en bois, imprégné d'huile et résistant à l'humidité, taille Gugelhupf

Ø cm                      ↑ cm  
00825                  25                  13,5



NEW

**Tablett mit Haube, 2-teilig**

tray with cover, 2 pcs.  
bandeja con cubierta, set de 2  
plateau avec cloche, set de 2



**Tablett aus Holz, ölimprägniert und feuchtigkeitsabweisend**  
wooden tray, oil-impregnated and moisture-repellent  
bandeja de madera, impregnada de aceite y repelente a la humedad  
plateau en bois, imprégné d'huile et résistant à l'humidité

cm                      ↑ cm  
00826                  28 x 14                  11,5





- 00393 oder / or 00396  
**96 x**
- 00391 oder / or 00398  
**96 x**
- 00392 oder / or 00399  
**96 x**
- 00394 oder / or 00395  
**96 x**

**Warenträger**

display  
expositor  
présentoir

für Partyplatten

- platzsparende flexible Präsentation durch geringe Abmessungen
- als Zweitplatzierung für Ihre zusätzlichen Umsätze
- in weiß lieferbar

for partytrays- space saving presentation- small size- available in white

para bandejas Party, ocupa poco espacio, disponible en blanco

pour plateaux Party, occupe très peu d'espace, disponible en blanc

	cm	↑ cm
00397	55 x 65	190



**Partyplatte „CLASSIC“**

partytray  
bandeja party  
plateau party



**Rand eingerollt**

rolled edge  
con filos en relieve  
bord rond

	cm	VE / unit	GN	
00396	Ø 35	48	-	round
00398	46,0 x 34,0	48	-	oval
00399	41,0 x 31,0	48	-	
00389	35,4 x 32,5	48	2/3	
00395	53,0 x 32,5	36	1/1	



**Partyplatte „CLASSIC“**

partytray  
bandeja party  
plateau party



**Rand eingerollt**

rolled edge  
con filos en relieve  
bord rond

	cm	VE / unit	GN	
00393	Ø 35	48	-	round
00391	46 x 34	48	-	oval

	cm	VE / unit	GN	
00392	41 x 31	48	-	
00394	53 x 32,5	36	1/1	

## TRAY · BOARD



### Tablett

tray  
bandeja  
plateau



**Tablett aus Edelstahl, hochglanzpoliert, stabiler Rand eingerollt**  
stainless steel tray, mirror polished finish, stable edge rolled in  
bandeja de acero inoxidable, pulido efecto espejo, borde estable enrollado  
plateau en acier inoxydable, effet brillant, bord stable enrollé

	Ø cm	↑ cm
30148	27	1,5



### Tablett

tray  
bandeja  
plateau



**Tablett aus Edelstahl, hochglanzpoliert, stabiler Rand eingerollt**  
stainless steel tray, mirror polished finish, stable edge rolled in  
bandeja de acero inoxidable, pulido efecto espejo, borde estable enrollado  
plateau en acier inoxydable, effet brillant, bord stable enrollé

	cm	↑ cm
30149	30 x 15,5	1,5



**Präsentationsmöglichkeit**  
presentation example



### Serviertablett „KAFFEEHAUS“

tray  
bandeja  
plateau



**matt poliert, oval, Rand eingerollt**  
satin polished finish, oval, rolled edge  
pulido acabado efecto satinado, oval, borde redondeado  
effet satin, ovale, bord rond

	cm	↑ cm	
30111	20,0 x 14,5	0,5	für Zucker und Sahne / for sugar and cream
30112	26,5 x 19,5	0,5	für eine Tasse / for one cup
30113	29,0 x 22,0	0,5	für zwei Tassen / for two cups
30123	23,0 x 17,5	0,5	Eisdielen-Größe / icecream pralor size



### Serviertablett „KAFFEEHAUS“

tray  
bandeja  
plateau



**hochglanzpoliert, oval, Rand eingerollt**  
mirror polished finish, oval, rolled edge  
pulido efecto espejo, ovalado, borde redondeado  
effet brillant, ovale, bord rond

	cm	↑ cm	
30115	20,0 x 14,5	0,5	für Zucker und Sahne / for sugar and cream para azúcar y crema / pour le sucre et la crème
30116	26,5 x 19,5	0,5	für eine Tasse / for one cup para una taza / pour une tasse
30117	29,0 x 22,0	0,5	für zwei Tassen / for two cups para dos tazas / pour deux tasses



Serviertablett „KAFFEEHAUS“

tray  
bandeja  
plateau



**matt poliert, Rand ingerollt**  
satin polished finish, rolled edge  
acabado pulido satinado, borde redondeado  
effet satin mat, bord rond

	cm	↑ cm
30118	21,5 x 13	1,5
30119	23,0 x 23	1,5
30120	20,0 x 11	1,5
30121	29,0 x 20	1,5



30119



**mattiert**  
satin polished finish

Serviertablett „KAFFEEHAUS“

tray  
bandeja  
plateau



	cm	↑ cm	
30126	25,5 x 19,5	2	mattiert / satin polished finish acabado efecto satinado / fini mat effet satin



84253

Serviertablett „KAFFEEHAUS“

tray  
bandeja  
plateau



	cm	↑ cm	Farbe / Colour
84251	26,0 x 20,0	1,5	■
84253	28,5 x 21,5	1,5	■



hot price

Serviertablett „KAFFEEHAUS“

tray  
bandeja  
plateau



**Innenfläche ziseliert, Rand ingerollt**  
rolled edge  
borde redondeado, superficie decor relieve  
bord rond, surface entièrement ciselée

	cm	pcs.
30114	30 x 22	48

## TRAY • BOARD



### Tablett „VINTAGE“

tray  
bandeja  
plateau

#### Antik-Edelstahl-Look

stainless steel antique look  
acero estilo antiguo  
acier style antique



	cm	↑ cm
30130	26,0 x 13,5	1,5
30131	34,0 x 18,0	1,5
30132	38,0 x 26,5	1,5
30133	25,5 x 16,0	3,0

#### passende Schälchen / fitting bowls / cuencos adecuados / bols appropriés

	Ø cm	↑ cm	litr.
40655	7,5	5,5	0,17
40656	7,5	10,0	0,35



S. 273  
page 273



Servierbeispiel  
presentation example

### Tablett „TREND“

baking sheet  
bandeja  
plateau

#### ein Backblech wird zum Serviertablett

a baking sheet which becomes a serving tray  
una bandeja de hornear que se convierte en una bandeja de servir  
un moule qui devient un plateau de service



	cm	↑ cm
13380	32 x 21,5	2





GN Tablett „FRAMES“

GN tray  
GN bandeja  
GN plateau



	cm	↑ cm	GN
82355	53,0 x 32,5	2	1/1
82356	32,5 x 26,5	2	1/2
82357	32,5 x 17,6	2	1/3



GN Tablett

GN tray  
GN bandeja  
GN plateau



	cm	↑ cm	GN
82201	53,0 x 32,5	2,5	1/1
82202	32,5 x 26,5	2,5	1/2
82203	32,5 x 17,6	2,5	1/3
82204	53,0 x 16,2	2,5	2/4
82205	35,4 x 32,5	2,5	2/3



GN Tablett „FRAMES“

GN tray  
GN bandeja  
GN plateau



	cm	↑ cm	GN
84046	53,0 x 32,5	2	1/1
84047	32,5 x 26,5	2	1/2
84048	32,5 x 17,6	2	1/3



**GN Naturschieferplatten**

GN natural slate tray  
GN bandeja de pizarra natural  
GN plat ardoise naturelle



hervorragende Kältespeicherung durch Naturschiefer, die Kanten der Platten sind gebrochen und nicht gesägt  
excellent coldness store, food safe, waterproof  
excelente conservador del frío, para reforzar la estética natural, los bordes ofrecen un canto irregular  
excellent maintien du froid, les bords sont volontairement cassés pour renforcer l'esthétique naturelle

	cm	✧ mm	GN
00990	53,0 x 32,5	6 - 9	1/1
00991	32,5 x 26,5	6 - 9	1/2
00992	32,5 x 17,6	6 - 9	1/3
00993	26,5 x 16,2	6 - 9	1/4
00973	53,0 x 16,2	6 - 9	2/4



**Naturschieferplatte**  
natural slate tray  
bandeja de pizarra natural  
plat ardoise naturelle



	cm	✧ mm
00996	45 x 30	6 - 9



**Naturschieferplatte**  
natural slate tray  
bandeja de pizarra natural  
plat ardoise naturelle



	cm	✧ mm
00994	25 x 25	6 - 9
00995	30 x 30	6 - 9

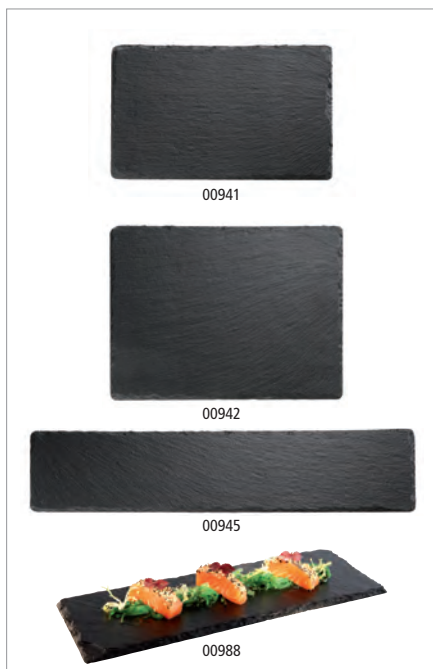

**Naturschieferplatte**  
 natural slate  
 bandeja de pizarra natural  
 plateau ardoise naturelle



	cm	* mm
00941	24,0 x 15,0	6 - 9
00942	26,5 x 20,5	6 - 9
00945	47,0 x 10,0	6 - 9
00988	30,0 x 12,0	6 - 9

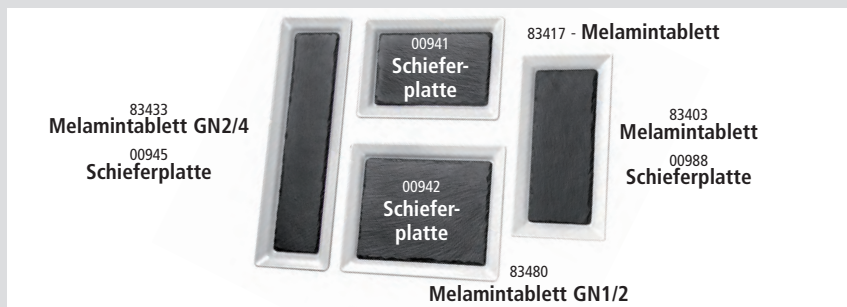

**GN 1/1 Naturschieferplatte „HOCHSTAPLER“**  
 GN 1/1 natural slate tray  
 GN 1/1 bandeja de pizarra natural  
 GN 1/1 plat ardoise naturelle



	cm	↑ cm	* mm
00966	53 x 32,5	6	6 - 9



Griffe verchromt, 4 cm Nutzhöhe  
 chrome plate handles, 4 cm distance



**Naturschieferplatte**  
 natural slate tray  
 bandeja pizarra natural  
 plat ardoise naturelle



mit Absatz Ø 6 cm  
 with hole Ø 6 cm  
 con agujero Ø 6 cm  
 avec trou Ø 6,0 cm

	cm	* mm
00986	25 x 12	6 - 9

passende Gläser:  
 82310, 82312, 82314, 82316



**Naturschieferplatte**  
 natural slate tray  
 bandeja pizarra natural  
 plat ardoise naturelle



mit 3 Absätzen, Ø 6 cm  
 with 3 holes, Ø 6 cm  
 con 3 agujeros, Ø 6 cm  
 avec 3 trous, Ø 6 cm

	cm	* mm
00987	28 x 10	6 - 9

passende Gläser:  
 82310, 82312, 82314, 82316



## TRAY · BOARD



### Naturschieferplatte „STARTER“

natural slate tray  
bandeja de pizarra natural  
plat ardoise naturelle carré



	cm	✱ mm
00937	20 x 10	6 - 9



### Naturschieferplatte / Untersetzer

natural slate tray  
bandeja de pizarra natural  
plateau ardoise naturelle



mit 2 Absätzen Ø 6 cm  
with 2 holes Ø 6 cm  
con 2 agujeros Ø 6 cm  
avec 2 trous Ø 6 cm

	cm	✱ mm
00971	15 x 8	6 - 9



### Naturschieferplatte

natural slate tray  
bandeja de pizarra natural  
plat ardoise naturelle



	Ø cm	✱ mm
00968	22	6 - 9
00969	28	6 - 9
00998	33	6 - 9
00999	38	6 - 9



### Tortenplatte / Servierplatte

drehbar  
cake stand  
soporte para pastel  
présentoir à gâteaux



	Ø cm	↑ cm	✱ mm
00975	32	2,5	6 - 9

drehbar / rotating



### Rolltop-Set, 3-teilig

rolltop set, 3 pcs.  
rolltop, set de 3  
rolltop, set de 3



1 Edelstahltablett Ø 38 cm + 1 Naturschieferplatte Ø 33 cm + 1 Rolltophaube Ø 38 cm

1 stainless tray Ø 38 cm + 1 natural slate tray Ø 33 cm + 1 rolltop cover Ø 38 cm

1 bandeja de acero inoxidable Ø 38 cm + 1 bandeja de pizarra natural Ø 33 cm + 1 tapa abatible Ø 38 cm

1 plat inox 38 cm + 1 plat ardoise naturelle 33 cm + 1 cloche 38 cm

	Ø cm	↑ cm
01000	38	24





### 3-stufige Etagère

3-tier tray  
bandeja con tres alturas  
étagère carré 3 hauteurs

Naturschiefer, Akazienholz  
natural slate tray, wood akazie  
bandeja de pizarra natural, madera de acacia  
plateau ardoise naturelle, bois d'acacia



	∅ cm	↑ cm	* mm
00960	30 / 25 / 20	34	6 - 9



### 2-stufige Etagère

2-tier tray  
bandeja dos alturas  
étagère carré 2 hauteurs

Naturschiefer  
natural slate tray  
bandeja de pizarra natural  
plateau ardoise naturelle



	∅ cm	↑ cm	* mm
00989	25 / 20	24	6 - 9



### Naturschieferplatte, 2-teilig

natural slate tray, 2 pcs.  
bandeja de pizarra natural y campana  
plateau ardoise naturelle et cloche en verre  
mit Glashaube  
with glass cover  
con tapa de cristal  
avec cloche en verre



	∅ cm	↑ cm	* mm
00984	10,5	8	6 - 9



### Naturschieferplatten, 4er Set

natural slate tray, 4 pcs.  
bandeja pizarra natural, set de 4  
plat ardoise naturelles, set de 4



	cm	* mm	pcs.
00997	10 x 10	6 - 9	4



## TRAY · BOARD



### Buffetbrett „PROFI“ board tabla para el buffet planche découper buffet



aus geöltem Eichenholz, Safrinne, mit Antirutsch-Füßchen

made of oiled oak, with juice groove and non slip-feet

de madera de roble aceitada, con ranura para líquidos y pies antideslizantes

en bois chêne huilé, avec rigole et pieds antidérapants

	cm	↑ cm	fits to
00806	58 x 37,5	4,5	11026, 11027, 11028, 11008, 11010, 11016



### GN 1/1 Servierbrett „GENUSSPALETTE“ GN 1/1 serving board GN 1/1 tabla de servir GN 1/1 planche de service



Genusspalette im Kleinformat, Birke

mini serving palett, birch

tabla de servir, formato pequeño, abedul

planche de service, petit format, bouleau

	cm	↑ cm	GN
00879	53 x 32,5	3	1/1



### Servierbrett „GENUSSPALETTE“ serving board tabla de servir planche de service



Genusspalette im Kleinformat, Birke

mini serving palett, birch

tabla de servir, formato pequeño, abedul

planche de service, petit format, bouleau

	cm	↑ cm
00880	20 x 12	3
00881	30 x 20	3
00882	40 x 15	3

Wachspapier „SNACKHOLDER“ / greaseproof paper squares  
papel alimenticio para cucurucho / papier alimentaire pour cornet

	cm	pcs.	
40670	42 x 25	500	Motiv: Zeitung
40671	42 x 25	500	blanco
40672	42 x 25	500	Motiv: rote Karos / red
40673	42 x 25	500	Motiv: blaue Karos / blue
40674	30 x 20	500	Motiv: Fast Food / black
40677	25 x 20	1000	Motiv: Zeitung
40678	31 x 31	1000	Motiv: Zeitung
40679	34 x 28	1000	Motiv: Zeitung

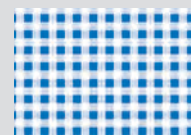
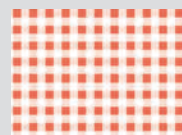



mit Absatz Ø 5 cm  
with hole Ø 5 cm

**Servierbrett, 2-teilig**

serving board, 2 pcs.  
tabla de servir, set de 2  
planche de service, set de 2

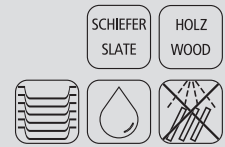

2-teilig:

1 Holzbrett aus Akazienholz + 1 Naturschieferplatte

1 wood board made of acacia wood + 1 natural slate tray

1 tabla de madera de acacia + 1 pizarra natural

1 planche en bois d'acacia + 1 ardoise naturelle

	cm	↑ cm
00814	28 x 17,5	2



00897

00898

40635

00899

**Servierbrett**

serving board  
tabla de servir  
planche de service



Servierbrett aus geöltem Akazienholz

serving board made of oiled acacia wood

tabla de servir de madera de acacia aceitada

planche en bois avec plateau en bois d'acacia huilé

	cm	↑ cm
00897	30 x 15	2
00898	30 x 18	2
00899	35 x 25	2



00810

00811

00812

00813

**Servierbrett, 2-teilig**

serving board, 2 pcs.  
tabla de servir, set de 2  
planche de service, set de 2



2-teilig:

Ein rustikales Servierbrett aus Akazienholz,  
ausgestattet mit einer Naturschieferplatte

wood board oiled acacia with a slate tray

tabla de madera de acacia con una bandeja de pizarra natural

planche en bois d'acacia avec un plateau en ardoise naturelle

	cm	↑ cm	Griff / handle cm
00810	26 x 18	2	8
00811	33 x 20	2	8
00812	40 x 15	2	5
00813	43 x 12	2	12

Präsentationsmöglichkeit  
presentation example



00813

mit Hängeloch Ø 2 cm / with a handle-hole Ø 2 cm



**Servierbrett „SHARING“**

serving board  
tabla de servir  
planche de service



Servierbrett aus geöltem Akazienholz  
serving board made of oiled acacia wood  
tabla de servir de madera de acacia aceitada  
planche en bois d'acacia huilé

	cm	↑ cm	Griff / handle cm
00887	51,5 x 18	1,5	8,5



**Servierbrett „AKAZIE-SCHIEFER“**

serving board  
tabla de servir  
planche de service



raffiniertes, rustikales Servierbrett  
aus Akazienholz, ausgestattet mit einem Naturschieferstreifen  
zur Kennzeichnung

wood with slate, markable  
madera con pizarra, se puede marcar  
bois avec ardoise, on peut mettre une inscription

	cm	↑ cm	Griff / handle cm
00867	30,5 x 13	1,5	10
00868	36,5 x 15	1,5	12
00869	42,0 x 18	1,5	14



**Servierbrett „OLIVE“**

serving board  
tabla de servir en madera de olivo  
planche de service en bois d'olivier



Servierbrett im Naturschnitt, aus Olivenholz. Jedes Brett wird handgefertigt und geölt mit 19 mm Aufhäng Bohrung. Alle Produkte unterscheiden sich naturbedingt in Form, Maserung und Größe!

Olive Wood is known for its versatility and striking appearance with each piece having its own unique features.

El olivo es conocido por su versatilidad y aspecto espectacular y único en cada pieza. Por su fabricación a mano de forma artesanal, todas las piezas varían en tamaño, forma y acabado, lo que hace de cada una un ejemplar único.

Le bois d'olivier est reconnu pour sa versatilité et son esthétique spectaculaire. De par leur fabrication artisanale à la main, toutes les pièces varient quant à leur taille, forme et finition, de telle sorte que chacune est un exemplaire unique.

	cm	↑ cm	Griff / handle cm
00870	25 x 17,0	1,5	
00871	30 x 20,5	2,0	
00872	35 x 24,0	2,0	
00873	40 x 15,0	1,5	11
00874	44 x 20,0	2,0	12
00875	19 x 12,5	1,5	6
00876	25 x 16,0	1,5	8
00877	31 x 20,0	1,5	9



NEW



00818



06510



06512

### Servier- und Tortenplatte

cake stand  
porta pasteles  
présentoir à gâteaux

**Eichenholz geölt, mit Safrille**

oak wood oiled, with juice groove  
madera de roble aceitada, con ranura para líquidos  
bois de chêne huilé, avec rainure à jus



	Ø cm	↑ cm
00818	32	2,0



06520

Präsentationsmöglichkeit  
presentation example



passende Hauben / cover / campana / cloche

	Ø cm	↑ cm
06510	30	11,5
06512	30	11,5
06520	30	22



00905



00906

### Servierbrett „OLIVE“

serving board  
tabla de servir  
planche de service

**aus geöltem Olivenholz**

oiled olive wood  
de madera de olivo aceitada  
en bois d'olivier huilé



	cm	↑ cm
00905	25,5 x 16,5	1,5
00906	35,0 x 20,5	1,5

Ø 9,5 cm



40601

### Servierbrett „OAK“

serving board  
tabla de servir  
planche de service

**aus geöltem Eichenholz, Safrille, ø 9,5 cm Aussparung**

made of oiled oak, with juice groove, with hole ø 9.5 cm  
de madera de roble aceitada, con ranura para líquidos, con agujero ø 9,5 cm  
en bois chêne huilé, avec rainure à jus, avec trou ø 9,5 cm



	cm	↑ cm
00808	37 x 25	2



mit Safrille  
with juice groove

NEW



01016



01017

Wachspapier  
40677



01016



40671

40670

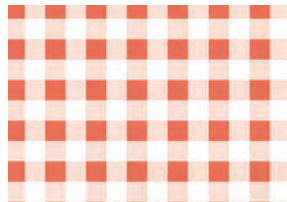

40672

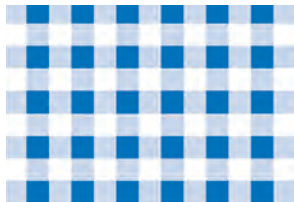

40673



40674



40678

Table Caddy „OLIVE“

table barrel  
caddy de mesa  
caddy de table



aus geöltem Olivenholz  
oiled olive wood  
de madera de olivo aceitada  
en bois d'olivier huilé

	cm	↑ cm
01016	22 x 15	6
01017	25 x 18	6



Allzweckstreuer, 12 er Set / shaker, 12 pcs. / dosificador, set de 12 / salières/poivrières set de 12

	cm	↑ cm	ltr.
40504	4 x 4	10	0,07

passende Brottasche / suitable bread basket / panera a juego / corbeilla assortie

	cm	↑ cm	Farbe / Colour
30356	12 x 11,5	11,5	■

passende Mühlen / suitable mills/ molinos de ajuste / moulins assortis

	ø cm	↑ cm
40555	6	15,5
40556	6	15,5

Wachspapier „SNACKHOLDER“

greaseproof paper squares  
papel alimenticio para cucurucho  
papier alimentaire pour cornet



	cm	pcs.	
40670	42 x 25	500	Motiv: Zeitung
40671	42 x 25	500	blanco
40672	42 x 25	500	Motiv: rote Karos / red
40673	42 x 25	500	Motiv: blaue Karos / blue
40674	30 x 20	500	Motiv: Fast Food / black
40677	25 x 20	1000	Motiv: Zeitung
40678	31 x 31	1000	Motiv: Zeitung
40679	34 x 28	1000	Motiv: Zeitung



40674

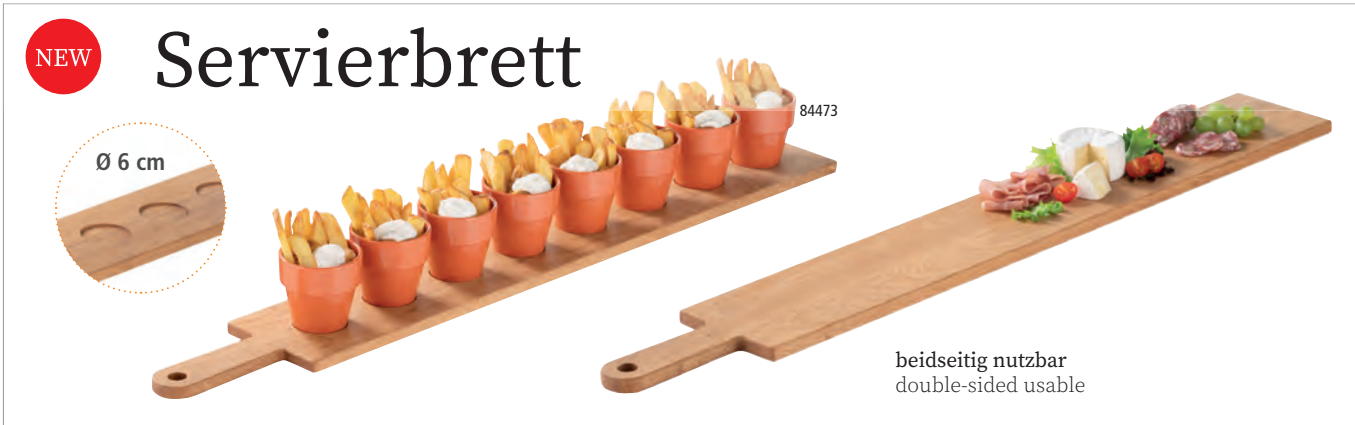

beidseitig nutzbar  
double-sided usable

**Servierbrett**

servicing board  
tabla de servir  
planche de service



aus geöltem Eichenholz, mit 8 Vertiefungen Ø 6 cm  
made of oiled oak wood, with 8 notches Ø 6 cm  
de madera de roble aceitada con 8 ranuras Ø 6 cm  
en bois de chêne huilé avec 8 encoches Ø 6 cm

	cm	↑ cm
00809	100 x 14	1,5



Präsentationsmöglichkeit  
presentation example

40636  
Henkelbecher  
beaker

mit Hängeloch Ø 2 cm / with a handle-hole Ø 2 cm



mit Hängeloch Ø 1,5 cm  
with a handle-hole Ø 1,5 cm

Präsentationsmöglichkeit  
presentation example

**Servierbrett**

servicing board  
tabla de servir  
planche de service



aus geöltem Buchenholz mit Daumenmulde auf einer Seite  
made of oiled beech wood with thumb recess on one side  
de madera de haya aceitada con hueco para el pulgar en un lado  
en bois de hêtre huilé avec encoche pour le pouce sur un côté

	cm	↑ cm
00817	60 x 19,5	2

## TRAY · BOARD



### Schale „OLIVE“

bowl  
cuenco  
bol



aus geöltem Olivenholz  
oiled olive wood  
de madera de olivo aceitada  
en bois d'olivier huilé

	cm	↑ cm	ltr.
01013	7,5 x 7,5	2,5	0,05
01014	17,5 x 8,5	2,5	0,15
01015	26,5 x 11,5	5,0	0,60



### Schale „OLIVE“

bowl  
cuenco  
bol



aus geöltem Olivenholz  
oiled olive wood  
de madera de olivo aceitada  
en bois d'olivier huilé

	Ø cm	↑ cm	ltr.
01010	10,0	4,0	0,15
01011	12,5	4,5	0,25
01012	15,0	6,0	0,50



3 Größen ineinander  
3 sizes in each other



### Schale „OLIVE“

bowl  
cuenco  
bol



aus geöltem Olivenholz  
oiled olive wood  
de madera de olivo aceitada  
en bois d'olivier huilé

	cm	↑ cm	ltr.
00843	12,0 x 7,5	2,5	0,05
00844	16,5 x 9,5	2,5	0,10





**Schale „OLIVE“**

bowl  
cuenco  
bol



aus geöltem Olivenholz  
oiled olive wood  
de madera de olivo aceitada  
en bois d'olivier huilé

	cm	↑ cm	ltr.
00907	13 x 8	6,5	0,2
00908	16 x 9	7,0	0,3



Servierbeispiel - Lieferung ohne Gläser  
delivery without glasses

**Holzbox „TABLE“**

woodbox  
caja madera  
base bois



Akazienholz, 3 Fächer (6,5 x 6,5 cm) / acacia wood, 3 compartments (6,5 x 6,5 cm)  
madera de acacia, 3 compartimentos (6,5 x 6,5 cm) / bois d'acacia, 3 compartiments (6,5 x 6,5 cm)

	cm	↑ cm	inner size cm
11727	23,5 x 8,5	4,5	6,5 x 6,5 je Fach / each compartment



Servierbeispiel - Lieferung ohne Gläser  
delivery without glasses

**Servierbrett „NARROW I“**

serving board  
tabla de servir  
planche de service



Akazienholz, mit 3 Vertiefungen Ø 4 cm / acacia wood, with 3 notches Ø 4 cm  
madera de acacia, con 3 ranuras Ø 4 cm / bois d'acacia, avec 3 encoches Ø 4 cm

	cm	↑ cm
00864	22 x 8	1,5

passende Schälchen / fitting bowls / cuencos adecuados / bols apropiés

	Ø cm	↑ cm	ltr.	
82312	6	5,5	0,08	glass / 12 pcs
40685	6	3,0	0,05	stainless steel



Servierbeispiel - Lieferung ohne Schälchen  
delivery without bowls

**Servierbrett „NARROW II“**

serving board  
tabla de servir  
planche de service



Akazienholz, mit 3 Vertiefungen Ø 6 cm  
acacia wood, with 3 notches Ø 6 cm  
madera de acacia, con 3 ranuras Ø 6 cm  
bois d'acacia, avec 3 encoches Ø 6 cm

	cm	↑ cm
00878	31 x 11	2

passende Schälchen / fitting bowls / cuencos adecuados / bols apropiés

	Ø cm	↑ cm	ltr.	
40686	8	4,5	0,17	stainless steel

# Buffetbrett „PROFI“



## Buffetbrett „PROFI“

board  
tabla para el buffet  
planche découper buffet

aus geöltem Eichenholz, Safrinne, mit Antirutsch-Füßchen

made of oiled oak, with juice groove and non slip-feet

de madera de roble aceitada, con ranura para líquidos y pies antideslizantes

en bois chêne huilé, avec rigole et pieds antidérapants



	Ø cm	↑ cm	fits to
00815	23	4,5	6519
00805	33	4,5	6520, 6510, 6512
00816	39	4,5	6521

## Frischhalte- Haube / cover / campana / cloche



	Ø cm	↑ cm	fits to
06512	30	11,5	00805

## Frischhalte- Haube / cover / campana / cloche



	Ø cm	↑ cm	fits to
06519	21	17	00815
06520	30	22	00805
06521	36	27	00816



## Buffetbrett „PROFI“

board  
tabla para el buffet  
planche découper buffet

aus geöltem Eichenholz, Safrinne, mit Antirutsch-Füßchen

made of oiled oak, with juice groove and non slip-feet

de madera de roble aceitada, con ranura para líquidos y pies antideslizantes

en bois chêne huilé, avec rigole et pieds antidérapants



	cm	↑ cm	fits to
00807	38 x 32,0	4,5	11021, 11022, 12008, 12010
00806	58 x 37,5	4,5	11026, 11027, 11028, 11008, 11010, 11016



00866

Brettstärke 4,5 cm  
board thickness

### Buffetbrett „XXL“

board  
tabla para el buffet  
planche à découper buffet



**Buchenholz geölt, mit Antirutsch-Füßchen**

beech wood oiled, with non-slip feet  
madera de haya tratada con aceite, con pies antideslizantes  
bois hêtre huilé, avec pieds antidérapants

	Ø cm	↑ cm
00866	50	4,5

### Rolltophaube / rolltop cover / campana rolltop / cloche rolltop

	Ø cm	↑ cm
18380	50	26

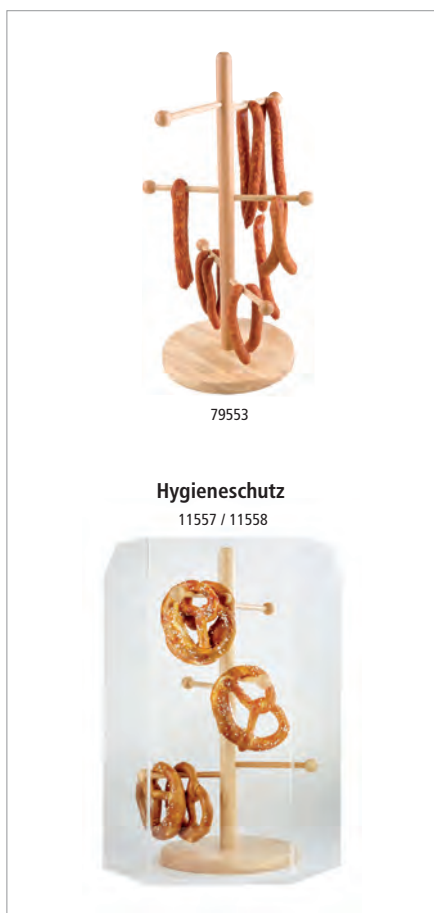

79553

Hygieneschutz  
11557 / 11558

### Brezel- oder Wurstständer

pretzel-/ sausage stand  
soporte para embutidos  
support à bretzel ou à saucissons



**Verkaufsständer Buchen-Holz versiegelt, bestens geeignet für die Präsentation von Brezeln, Würstchen, etc., Fuß Ø 22 cm**

beech wood, ideal to present pretzels, sausages, etc.  
madera de haya, ideal para presentar fiambres, salchichones etc.  
en hêtre, idéal pour bretzels ou saucissons, etc.

	Ø cm	↑ cm
79553	28	50

### Hygieneschutz für Brezelständer / hygienic cover / cubierta higiénica antialiento / pare-haleine

	cm	↑ cm
11557	20 x 20 x 20	50
11558	15 x 20 x 15	50



### Hobel für Käse und Schokolade

cheese / choco curler  
rizador para queso y chocolate  
frisette pour fromage et chocolat



**3-teilig: Platte Buchen-Holz versiegelt Ø 22 cm mit senkrechtem Stift + Hobel 7 cm + Haube Ø 15 x 10 cm, für Käse und Schokolade**

3 pcs.: wooden base Ø 22 cm with vertical bolt + plough 7 cm + cover Ø 15 x 10 cm, for cheese and chocolate

set de 3: base de madera Ø 22 cm, con eje vertical de 7 cm + campana Ø 15 x 10 cm, para „rizar“ queso y chocolate

set de 3: base bois Ø 22 cm, axe vertical ht. 7 cm, cloche Ø 15 x ht 10 cm, pour „friser“ le fromage ou le chocolat.

	Ø cm	↑ cm
50002	22	15

## TRAY · BOARD



### Brotschneidebrett „PROFI“

cutting board  
tabla para cortar  
planche à découper



	cm	↑ cm
00806	58 x 37,5	4



### Brotschneidebrett „LETTER“

cutting board  
tabla para cortar  
planche à découper



	cm	↑ cm
00886	48 x 34	3,5



### Brotschneidebrett „AKAZIA“

cutting board  
tabla para cortar  
planche à découper



	cm	↑ cm	GN
00883	47,5 x 32,0	2	
00884	53,0 x 32,5	2	1/1
00885	60,0 x 40,0	2	



praktisches Krümfach  
practical crump shelf



### Brotschneidebrett „RUBBERWOOD“

cutting board  
tabla para cortar  
planche à découper



	cm	↑ cm	GN
00955	47,5 x 32,0	2	
00956	53,0 x 32,5	2	1/1
00957	60,0 x 40,0	2	



praktisches Krümfach  
practical crump shelf



### Brotschneidebrett, 2-teilig

cutting board, 2 pcs.  
tabla para cortar, set de 2  
planche à découper, set de 2



2-teiliges Set, GN 1/1 Behälter, 20 mm tief, dient als Krümfach

2 pcs.: GN 1/1 pan 20 mm, bread crump shelf

set de 2: tabla de corte + bandeja inox GN 1/1 alt 20 mm (sirve para recoger las migas)

set de 2: planche à découper bois + plateau inox GN 1/1 Ht 20 mm (sert de ramassemiettes)

	cm	GN
00951	53 x 32,5	1/1

einzelnes Brett / separate board / tabla por separado / planche seule

	cm	GN
00952	53 x 32,5	1/1





00510

**Serviertablett „HAPPY HOUR“**

tray  
bandeja  
plateau



**rutschfeste Oberfläche**  
non-slip surface  
superficie anti deslizante  
surface antidérapante

	Ø cm	↑ cm	Farbe / Colour
00510	32	1,5	■
00511	38	1,5	■
00515	43	1,5	■



00548

**Tablett „GASTRO“**

tray  
bandeja  
plateau



**rutschfeste Oberfläche**  
non-slip surface  
superficie anti deslizante  
surface antidérapante

	Ø cm	↑ cm	Farbe / Colour
00547	27,5	2	■
00548	35,5	2	■
00549	40,5	2	■



**Tablett „BISTRO“**

tray  
bandeja  
plateau



**rutschfest, mit 2 Griffmulden und Stapelrand**  
non-slip, two open handles, stackable edge  
anti deslizante, 2 asas  
antidérapant, 2 anses

	Ø cm	↑ cm	Farbe / Colour
84045	35,5	4,5	■



00500

00507

**Bierglasträger „NON SLIP“**

beer rack  
bandeja para cerveza  
porte verre à bière



**rutschfeste Oberfläche**  
non-slip surface  
superficie anti deslizante  
surface antidérapante

	Ø cm	↑ cm	Farbe / Colour
00500	36	3,5	■
00501	36	3,5	■

	cm	↑ cm	Farbe / Colour
00506	28 x 20	1,5	■
00507	28 x 20	1,5	■

## TRAY · BOARD



84620  
oval 22 x 14 cm

84621  
Ø 19 cm

### Teller mit Glashalter „COCKTAIL“

plate with glass holder  
plato sujeta copas  
assiette porte-verre



eignet sich besonders für Stehempfänge, einhändig nutzbar  
particularly suitable for standing receptions, single-handed use  
para uso en recepciones de pie, facil de usar con sólo una mano  
particulièrement pour des receptions debout, utilisable avec une seule main

	cm	↑ cm
84620	22 x 14	1,5



	Ø cm	↑ cm
84621	19	1,5

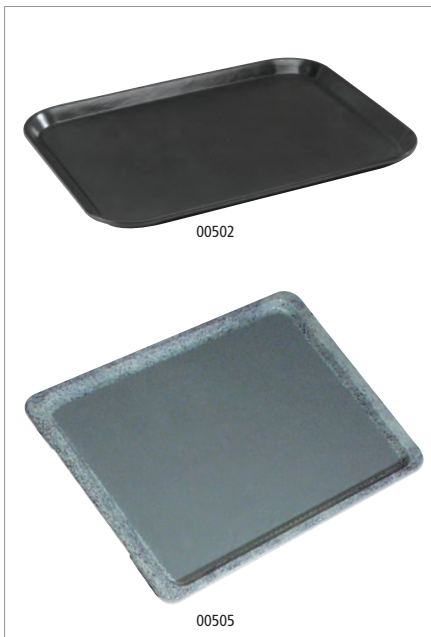

00502

00505

### Serviertablett „NON SLIP“

tray non-slip  
bandeja  
plateau



rutschfeste Oberfläche  
non-slip surface  
superficie antideslizante  
surface antidérapante

	cm	↑ cm	GN	Farbe / Colour
00502	53,0 x 32,5	1,5	1/1	■
00508	46,0 x 36,0	2,0		■
00505	53,0 x 32,5	1,5	1/1	■
00503	53,0 x 37,0	1,5		■



00526

### Tablett

tray  
bandeja  
plateau



rutschfest, Holzdekor-Laminat  
non-slip, coated wood  
antideslizante, decoración madera láminae  
antidérapant, décor bois laminé

	cm	↑ cm
00524	43,5 x 31,5	1,5
00525	52,0 x 39,0	1,5
00526	60,5 x 42,5	1,5



**Fast Food-Tablett**

snack tray  
bandeja autoservicio y snacks  
plateau self-service et snacks



	cm	↑ cm	GN	Farbe / Colour
00530	35 x 27,0	2		
00535	41 x 30,5	2		
00540	45 x 35,5	2		
00552	53 x 32,5	2	1/1	

	cm	↑ cm	GN	Farbe / Colour
00531	35 x 27,0	2		
00536	41 x 30,5	2		
00541	45 x 35,5	2		
00553	53 x 32,5	2	1/1	

	cm	↑ cm	GN	Farbe / Colour
00532	35 x 27,0	2		
00537	41 x 30,5	2		
00542	45 x 35,5	2		
00554	53 x 32,5	2	1/1	

	cm	↑ cm	GN	Farbe / Colour
00533	35 x 27,0	2		
00538	41 x 30,5	2		
00543	45 x 35,5	2		
00555	53 x 32,5	2	1/1	



**Tablett**

tray  
bandeja  
plateau



**rutschfest, Mahagonifurnier**  
non-slip, woodform, mahogany  
antideslizante, revestimento de caoba  
antidérapant, placage en acajou

	Ø cm	↑ cm	
00528	31,0	3,5	hoher Rand
00529	35,5	3,5	hoher Rand



**Tablett**

tray  
bandeja  
plateau



**rutschfest, Holzdekor-Laminat**  
non-slip, coated wood  
antideslizante, limando decoracion madera  
antidérapant, décor bois stratifié

	cm	↑ cm
00521	26 x 20	1
00522	29 x 21	1

## CAKE STAND • COVER

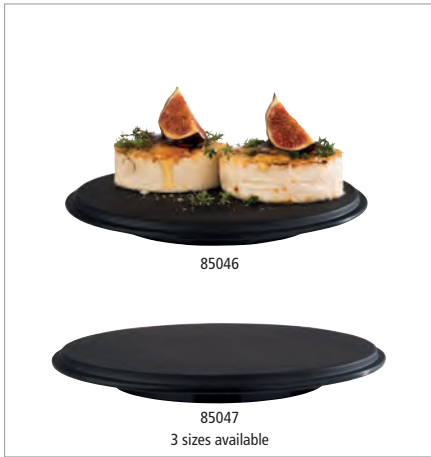

### Torten- / Konditorplatte „SLATE“

cake stand  
soporte para pastel  
présentoir à gâteaux



Rand fixiert die Haube, mit Antirutsch-Füßchen, Schiefer Look

carved edge fixes the cover, with non-slip feet, slate look  
ranura para fijar bien la campana, con pies antideslizantes, aspecto pizarra  
bord rainuré pour maintenir ferme la cloche, avec pieds antidérapants, aspect ardoise



	Ø cm	↑ cm	fits to cover
85046	21,5	2,5	06519
85047	30,5	3,5	06520, 06512, 6510
85048	37,5	4,0	06521



### Torten- / Konditorplatte „LOOPS“

cake stand  
soporte para pastel  
présentoir à gâteaux



	Ø cm	↑ cm	fits to cover
85033	21,5	2,5	06519
85034	30,5	3,5	06520, 06512, 06510
85035	37,5	4,0	06521

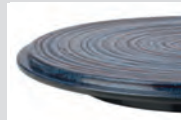

Rand fixiert die Haube, mit Antirutsch-Füßchen  
carved edge fixes the cover, with non-slip feet



### Torten- / Konditorplatte

cake stand  
soporte para pastel  
présentoir à gâteaux



Rand fixiert die Haube, mit Antirutsch-Füßchen

carved edge fixes the cover, with non-slip feet  
ranura para fijar bien la campana, con pies antideslizantes  
bord rainuré pour maintenir ferme la cloche, avec pieds antidérapants



	Ø cm	↑ cm	Farbe / Colour	fits to cover
00468	31	3,5	■	06520
00469	31	3,5	■	06520



### Servier- und Tortenplatte „CASUAL“

cake plate  
porta pasteles  
présentoir à gâteaux



	Ø cm	↑ cm
83890	31	8
83891	31	16



### Servier- und Tortenplatte „CASUAL“

cake plate  
porta pasteles  
présentoir à gâteaux



	cm	↑ cm
83892	31 x 31	8
83893	31 x 31	16





**Servier- und Tortenplatte**

cake stand  
porta pasteles  
présentoir à gâteaux



Eichenholz geölt / oak wood oiled / mader de roble aceitada / bois de chêne huilé

	Ø cm	↑ cm
00818	32	2,0



**Konditorplatte**

cake stand  
soporte para pastel  
présentoir à gâteaux



**matt poliert**  
satin polished finish  
acabado efecto satinado  
poli mat effet satin

	Ø cm	↑ cm
00046	31	3



**Servier- und Tortenplatte „CLASSIC“**

cake stand  
porta pasteles  
présentoir à gâteaux



**Rand fixiert die Haube**  
carved edge fixes the cover  
ranura para fijar bien la campana  
bord rainuré pour maintenir ferme la cloche

	Ø cm	↑ cm
85051	30,5	9
85052	30,5	17

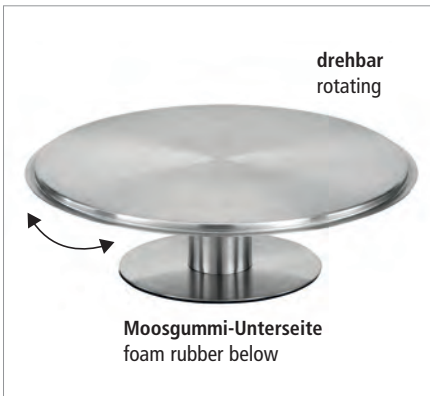

**Servier- / Tortenplatte**

cake stand  
soporte para pastel  
présentoir à gâteaux



**matt poliert, drehbar, möbelschonende Moosgummi-Unterseite**  
satin polished finish, rotating, foam rubber below to save your furniture  
acabado pulido satinado, giratorio, base revestida de goma para no rallar el mobiliario  
poli satiné, plateau tournant, revêtement mousse sous le pied pour ne pas rayer les meubles

	Ø cm	↑ cm
00463	30,5	9

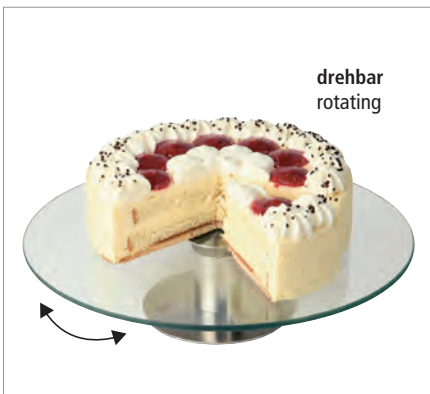

**Servier- / Tortenplatte**

cake stand  
soporte para pastel  
présentoir à gâteaux



**Fuß matt poliert, drehbar, möbelschonende Moosgummi-Unterseite**  
foot satin polished finish, rotating, foam rubber below to save your furniture  
vidrio, pie inox satinado giratorio, base de goma para proteger el mobiliario  
plateau en verre, pied tournant inox poli satin, revêtement mousse sous le pied anti-rayures

	Ø cm	↑ cm
00444	30	7

CAKE STAND • COVER



Servier- und Tortenplatte „ACACIA MINI“

cake stand  
porta pasteles  
présentoir à gâteaux



Akazienholz geölt  
acacia wood oiled  
madera de acacia aceitada  
bois d'acacia huilé

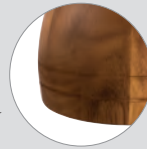

mit Rille  
with groove

	Ø cm	↑ cm
33290	9,5	7
33291	13,0	9

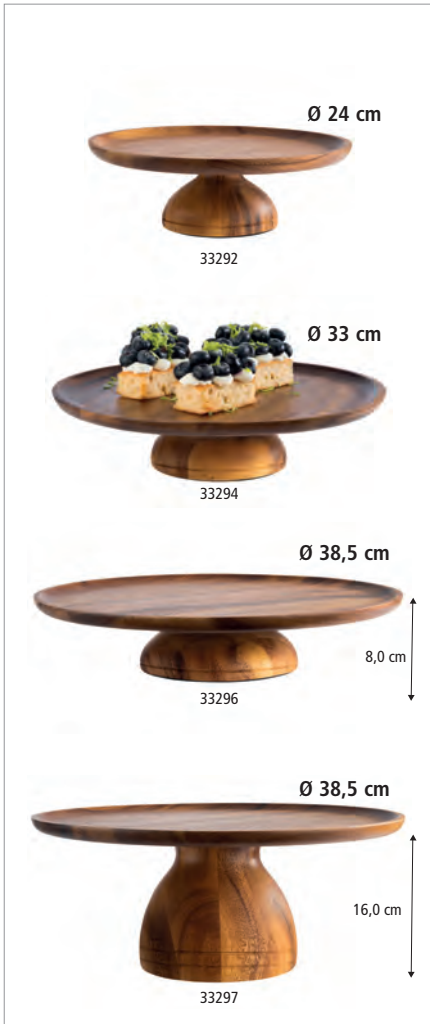

Servier- und Tortenplatte „ACACIA“

cake stand  
porta pasteles  
présentoir à gâteaux



Akazienholz geölt, möbelschonende Unterseite  
acacia wood oiled, with non-scratching undersurface  
madera de acacia aceitada, con base anti rayaduras  
bois d'acacia huilé, avec revêtement antirayures

	Ø cm	↑ cm
33292	24,0	8
33293	24,0	16
33294	33,0	8
33295	33,0	16
33296	38,5	8
33297	38,5	16



mit Rille  
with groove

Frischhalte- Haube / cover / campana / cloche



	Ø cm	↑ cm	fits to
06519	21	17	33292, 33293
06520	30	22	33294, 33295
06521	36	27	33296, 33297

# SUPER DOME



## Frischhalte-Haube „SUPER DOME“

cover  
campana  
cloche



schwere, glasklare Qualität  
stable, crystal clear quality  
muy resistente y transparencia cristalina  
haute résistance et transparence

	Ø cm	↑ cm
06525	30	40

passende Servier- Tortenplatten / suitable cake stands / porta pasteles compatibles /  
présentoirs à gâteaux compatibles

	Ø cm	↑ cm	fits to	Farbe / Colour
85051	30,5	9,0	06525	
85052	30,5	17,0	06525	
00468	31,0	3,5	06525	
85112	32,0	3,5	06525	
33294	33,0	8,0	06525	
33295	33,0	16,0	06525	

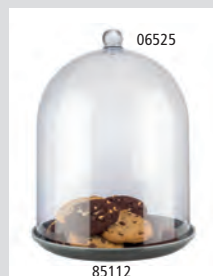

Servierbeispiel  
presentation example

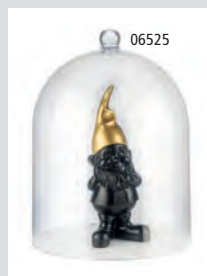

Präsentationsmöglichkeiten  
presentation examples





## CUTLERY BOX



### Besteckbehälter „ACACIA“

cutlery box  
recipiente para cubiertos  
réipient pour couverts

HOLZ  
WOOD

**Akazienholz natur, 4 Fächer (26 x 11,5 cm)**

acacia wood nature, 4 compartments (26 x 11,5 cm)  
madera de acacia natural, 4 compartimentos (26 x 11,5 cm)  
bois d'acacia naturel, 4 compartiments (26 x 11,5 cm)

	cm	↑ cm	Farbe / Colour
11952	51 x 28	13	



### Besteckbehälter „VINTAGE“

cutlery box  
recipiente para cubiertos  
réipient pour couverts

HOLZ  
WOOD

**Akazienholz vintage weiß, 4 Fächer (26 x 11,5 cm)**

acacia wood, vintage white, 4 compartments (26 x 11,5 cm)  
madera de acacia, blanca vintage, 4 compartimentos (26 x 11,5 cm)  
bois d'acacia, blanc vintage, 4 compartiments (26 x 11,5 cm)

	cm	↑ cm	Farbe / Colour
11951	51 x 28	13	



### Besteckbehälter „ACACIA“ mit Deckel

cutlery box with cover  
caja de cubiertos con tapa  
range-couverts avec couvercle

HOLZ  
WOOD

ACRYL  
ACRYLIC



**Akazienholz natur, 4 Fächer (26 x 11,5 cm)**

acacia wood nature, 4 compartments (26 x 11,5 cm)  
madera de acacia natural, 4 compartimentos (26 x 11,5 cm)  
bois d'acacia naturel, 4 compartiments (26 x 11,5 cm)

	cm	↑ cm	Farbe / Colour
11949	51 x 28	14,5	



### Besteckbehälter „VINTAGE“ mit Deckel

cutlery box with cover  
caja de cubiertos con tapa  
range-couverts avec couvercle

HOLZ  
WOOD

ACRYL  
ACRYLIC



**Akazienholz vintage weiß, 4 Fächer (26 x 11,5 cm)**

acacia wood, vintage white, 4 compartments (26 x 11,5 cm)  
madera de acacia, blanca vintage, 4 compartimentos (26 x 11,5 cm)  
bois d'acacia, blanc vintage, 4 compartiments (26 x 11,5 cm)

	cm	↑ cm	Farbe / Colour
11948	51 x 28	14,5	





**GN 1/1 Besteckbehälter**

GN 1/1 dispenser GN  
GN 1/1 dispensador de cubiertos  
GN 1/1 bac à couverts



in Handarbeit geflochten, 4 Mulden, Kunststoff-Geflecht, Drahtgestell, braun-schwarz

wickerwork, 4 compartments, with reinforced chromed wire structure, brown-black

cesta trensada a mano, 4 compartimentos, de plástico, con bastidor cromado reforzado, marrón oscuro

corbeille tressée à main, 4 compartiments, en plastique, cadre acier chromé renforcé, couleur marron foncé

	cm	↑ cm	Farbe / Colour
11966	53 x 32,5	9	



**GN 1/1 Besteckbehälter „BUFFET“**

GN 1/1 cutlery dispenser  
GN 1/1 dispensador de cubiertos  
GN 1/1 bac à couverts

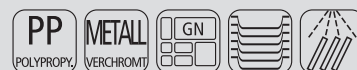

4 Mulden, Kunststoff-Geflecht, Drahtgestell, beige

4 troughs, wickerwork, wire, beige

4 huecos, trabajo de cestería

4 compartiments, plastique tressé, cadre acier chromé renforcé, couleur osier naturel

	cm	↑ cm	Farbe / Colour
11965	53 x 32,5	10	



**GN 1/1 Besteckbehälter**

GN 1/1 cutlery tray / box stand  
GN 1/1 dispensador de cubiertos  
GN 1/1 bac à couverts



	cm	↑ cm	Farbe / Colour
11955	53 x 32,5	10	



**GN 1/1 Besteckkasten**

cutlery box GN 1/1  
GN 1/1 dispensador de cubiertos  
GN 1/1 bac à couverts



	cm	↑ cm	Farbe / Colour
11960	53 x 32,5	10	



**GN 1/1 Besteckbehälter**

GN 1/1 cutlery bin  
GN 1/1 recipiente para cubiertos  
GN 1/1 récipients pour couverts



	cm	↑ cm	Farbe / Colour
11954	53 x 32,5	10	
11955	53 x 32,5	10	

## CUTLERY BOX



11998  
Köcher weiß  
PE white

11999  
Köcher Edelstahl  
stainless steel

### Besteckköcher cutlery basket cesta para cubiertos corbeille à couverts



	Ø cm	↑ cm	
11998	9,7	13,7	Kunststoff weiß / white plastic plástico blanco / plastique blanc
11999	9,7	13,7	matt poliert / satin polished finish acero inoxidable / inox



11994

11997

### Besteckbehälter cutlery basket dispensador de cubiertos présentoir à couverts



**matt poliert**  
satin polished finish  
inox mate (sin cubiertos)  
inox mat

	cm	↑ cm	
11994	26,0 x 30 Ø 10	20	4 Löcher inkl. Köcher (Kunststoff) 4 holes incl. dispensers (plastic) 4 agujeros incl. dispensador plástico 4 places, avec 4 récipients (plastique)
11997	37,5 x 30 Ø 10	20	6 Löcher ohne Köcher 6 holes without dispensers 6 agujeros sin dispensador de plástico 6 places, sans récipients



### Besteckbehälter cutlery basket recipiente para cubiertos récipients pour couverts



**4 Löcher inkl. 4 Edelstahl Köcher**  
4 holes incl. 4 stainless baskets  
4 agujeros, incl. 4 cestas de acero  
4 places, avec 4 corbeilles inox

	cm	↑ cm	Farbe / Colour
93321	27 x 27	15	■



### Besteckbehälter „ACACIA“ cutlery bin recipiente para cubiertos récipients pour couverts



**Akazienholz natur**  
acacia wood nature  
madera de acacia natural  
bois d'acacia naturelle

	cm	↑ cm	Logo
11939	14 x 14	15	fork / knife / spoon

## VINTAGE

**Table Caddy „VINTAGE“**

table caddy  
caddy de mesa  
caddy de table



unterteilt in 5 Fächer  
divided into 5 compartments  
dividido en 5 compartimentos  
divisé en 5 compartiments

	cm	↑ cm
11608	22 x 15,5	11,5

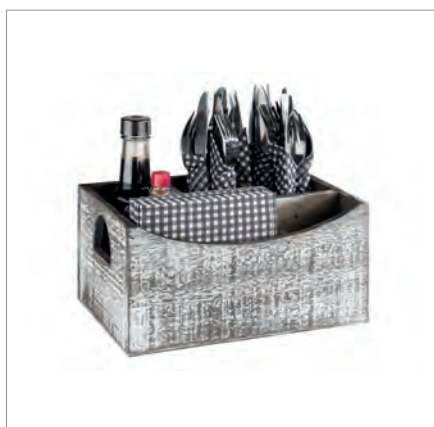
**Table Caddy „VINTAGE“**

table caddy  
caddy de mesa  
caddy de table



unterteilt in 7 Fächer  
divided into 7 compartments  
dividido en 7 compartimentos  
divisé en 7 compartiments

	cm	↑ cm
11609	25,5 x 15,5	11,5

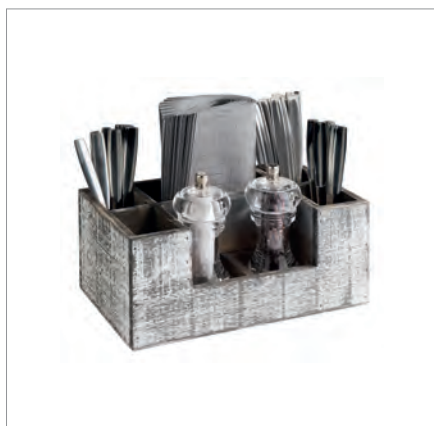
**Table Caddy „VINTAGE“**

table caddy  
caddy de mesa  
caddy de table



unterteilt in 4 Fächer, mit Tragegriff  
divided into 4 compartments, with handle  
dividido en 4 compartimentos, con asa  
divisé en 4 compartiments, avec poignée

	cm	↑ cm
11610	22 x 15,5	22



## CUTLERY BOX



### Table Caddy „VINTAGE“

table caddy  
caddy de mesa  
caddy de table



herausnehmbare Aufteilung, 6 Fächer (7,5 x 7,5 cm)  
separation removable, 6 compartments (7,5 x 7,5 cm)  
separadores amovibles, 6 compartimentos (7,5 x 7,5 cm)  
séparateurs amovibles, 6 compartiments (7,5 x 7,5 cm)

	cm	↑ cm	Farbe / Colour
11638	27 x 17	10	

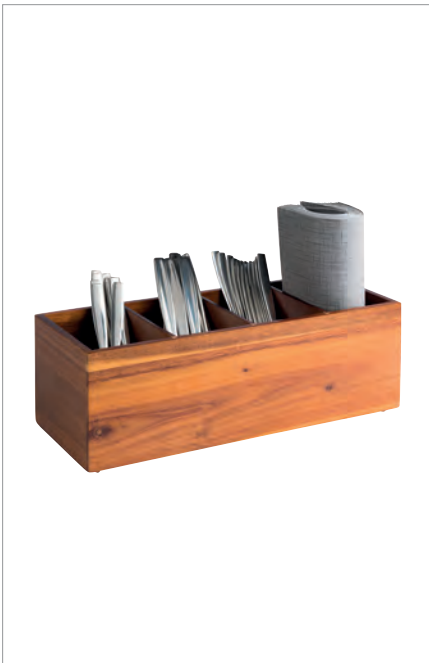

### Holzbox „WOODY“

woodbox  
caja madera  
base bois



Akazienholz, 4-Fächer  
acacia wood, 4 compartements  
madera de acacia, 4 compartimentos  
bois d'acacia, 4 compartiments

	cm	↑ cm	inner size cm
11649	36 x 14	12,5	12,5 x 8



### Besteckbehälter „TIN“

cutlery bin  
recipiente  
récipient



Behälter aus Metall mit Tragegriff aus Holz  
container made of metal with wooden handle  
contenedor de metal con asa de madera  
conteneur métallique avec poignée en bois

	cm	↑ cm
00014	24,5 x 12	18,5





inkl. Beschwerer



**Serviettenhalter „HERO“**

napkin holder  
servilletero  
porte-serviettes



für ca. 65 Cocktailservietten, inkl. Beschwerer

for approx. 65 cocktail napkins, incl. weight  
para aprox. 65 servilletas cocktail, incl. barra de contrapeso  
pour environ 65 serviettes cocktail, incl. barre de contrepoids

	cm	↑ cm	
11767	14,5 x 14,5	10	für 65 Servietten / for 65 napkins para 65 servilletas / pour 65 serviettes



inkl. Beschwerer



**Serviettenhalter „HERO“**

napkin holder  
servilletero  
porte-serviettes



für ca. 95 Servietten 1/4 Falz, inkl. Beschwerer

for approx. 95 cocktail napkins, incl. weight  
para aprox. 95 servilletas cocktail, incl. barra de contrapeso  
pour environ 95 serviettes cocktail, incl. barre de contrepoids

	cm	↑ cm	
11768	18,5 x 18,5	14	für 95 Servietten / for 95 napkins para 95 servilletas / pour 95 serviettes



inkl. Beschwerer



**Serviettenhalter „URBAN“**

napkin holder  
servilletero  
porte-serviettes



für ca. 50 Servietten, inkl. Beschwerer

for approx. 50 napkins, incl. weight  
para aprox. 50 servilletas, incl. barra de contrapeso  
pour environ 50 serviettes, incl. barre de contrepoids

	cm	↑ cm	
11770	19 x 19	7,5	für 50 Servietten / for 50 napkins para 50 servilletas / pour 50 serviettes



inkl. Beschwerer



**Serviettenhalter „URBAN“**

napkin holder  
servilletero  
porte-serviettes



für ca. 120 Servietten 1/4 Falz, inkl. Beschwerer

for approx. 120 cocktail napkins, incl. weight  
para aprox. 120 servilletas de plegado ¼, incl. barra de contrapeso  
pour environ 120 serviettes pliage ¼, incl. barrie de contrepoids

	cm	↑ cm	
11771	19 x 19	18	für 120 Servietten / for 120 napkins para 120 servilletas / pour 120 serviettes

## NAPKINHOLDER



### Serviettenhalter „WIRE“

napkin holder  
servilletero  
porte-serviettes



**für Servietten 1/4 Falz, inkl. Beschwerer**

for napkins 1/4 fold, incl. weight  
para servilletas plegado 1/4, incl. barra de contrapeso  
pour serviettes pliage 1/4, incl. barre de contrepoids

	cm	↑ cm	
11763	19 x 19	6,5	für 50 Servietten / for 50 napkins para 50 servilletas / pour 50 serviettes



### Serviettenhalter „WIRE“

napkin holder  
servilletero  
porte-serviettes



**für Servietten 1/4 Falz, inkl. Beschwerer**

for napkins 1/4 fold, incl. weight  
para servilletas plegado 1/4, incl. barra de contrapeso  
pour serviettes pliage 1/4, incl. barre de contrepoids

	cm	↑ cm	
11765	19 x 19	19,0	für 150 Servietten / for 150 napkins para 150 servilletas / pour 150 serviettes

11765



### Serviettenhalter „BAR“

napkin holder  
servilletero  
porte-serviettes



**für ca. 50 Cocktailservietten, inkl. Beschwerer**

for approx. 50 cocktail napkins, incl. weight  
para aprox. 50 servilletas cocktail, incl. barra de contrapeso  
pour environ 50 serviettes cocktail, incl. barre de contrepoids

	cm	↑ cm	
11762	14 x 14	6,5	für 50 Servietten / for 50 napkins para 50 servilletas / pour 50 serviettes



### Serviettenhalter

napkin holder  
servilletero  
porte-serviettes



**matt poliert**

satin polished finish  
acabado satinado  
mat satiné

	cm	↑ cm	
11730	17 x 17	5	



**Serviettenhalter „ELEMENT“**

napkin holder  
servilletero  
porte-serviettes



aus Beton, für ca. 50 Servietten, mit möbelschonender Unterseite  
concrete, for approx. 50 napkins, with furniture-friendly underside  
hormigón, para aprox. 50 servilletas, con base anti rayaduras  
béton, pour environ 50 serviettes, avec revêtement antirayures

	cm	↑ cm	
11781	16 x 7,5	10	für 50 Servietten / for 50 napkins para 50 servilletas / pour 50 serviettes



**Serviettenhalter**

napkin holder  
servilletero  
porte-serviettes



hochglanzpoliert, für Servietten mit 1/8 Falz, Füße mit rutsch- und kratzfester Gummierung  
mirror polished finish, for napkins with 1/8 fold, rubber feet  
pulido brillante, para servilletas plegado 1/8, con revestimiento de goma  
poli miroir, pour serviettes pliage 1/8, avec revêtement en caoutchouc

	cm	↑ cm	
11720	10 x 11,5	18,5	



**Serviettenhalter**

napkin holder  
servilletero  
porte-serviettes



möbelschonende Unterseite, für ca. 30 Servietten, matt poliert  
furniture-friendly underside, for approx. 30 napkins, satin polished finish  
con base anti rayaduras, para aprox. 30 servilletas, pulido mate  
avec revêtement antirayures, pour environ 30 serviettes, poli mat

	cm	↑ cm	
11780	15 x 4,5	12,5	für 30 Servietten / for 30 napkins para 30 servilletas / pour 30 serviettes



**Serviettenhalter**

napkin holder  
servilletero  
porte-serviettes



möbelschonende Unterseite, für ca. 20 Servietten, matt poliert  
furniture-friendly underside, for approx. 20 napkins, satin polished finish  
con base anti rayaduras, para aprox. 20 servilletas, pulido mate  
avec revêtement antirayures, pour environ 20 serviettes, poli mat

	cm	↑ cm	
11778	17 x 3	7	für 20 Servietten / for 20 napkins para 20 servilletas / pour 20 serviettes









# Buffet & Tableware Melamine



# MOON



Servierset „MOON“, 6-teilig  
 serving set, 6 pcs.  
 set para servir, set de 6  
 set de service, set de 6



6-teiliges Set: 3 Schalen + 3 Löffel  
 6 pcs.: 3 bowls + 3 spoons  
 set de 6: 3 cuencos + 3 cucharas  
 set de 6: 3 bols + 3 cuillères

	Ø cm	↑ cm	ltr.	Farbe / Colour
85080	8	7,5	0,05	
85081	8	7,5	0,05	







Servierset „MOON“, 2-teilig

serving set, 2 pcs.  
set para servir, set de 2  
set de service, set de 2



2-teiliges Set: 1 Schale + 1 klappbarer Deckel

2 pcs.: 1 bowl + 1 hinged cover

set de 2: 1 cuenco + 1 tapa con bisagra

set de 2: 1 bol + 1 couvercle avec charnières

	Ø cm	↑ cm	ltr.	Farbe / Colour
85082	19	17,5	0,8	
85083	19	17,5	0,8	

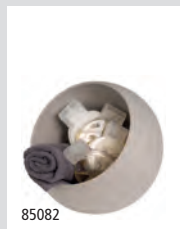

klappbarer Deckel  
hinged cover

Präsentationsmöglichkeit  
presentation example

Klappdeckel „Moon“ mit Silikondichtung / hinged cover with silicone seal / tapa con bisagra con junta de silicona / couvercle avec charnières avec joint en silicone

	Ø cm	↑ cm	fits to
85084	16	1,5	85082, 85083



84938  
Tablett / tray

# EMMA



## Schale „EMMA“ bowl cuenco bol



	Ø cm	↑ cm	ltr.	Farbe / Colour
85100	7,5	3,5	0,06	■
85101	7,5	3,5	0,06	■
85103	7,5	3,5	0,06	■
85104	14	6,5	0,5	■
85105	14	6,5	0,5	■
85107	14	6,5	0,5	■
85108	23	10,5	2,3	■
85109	23	10,5	2,3	■
85111	23	10,5	2,3	■

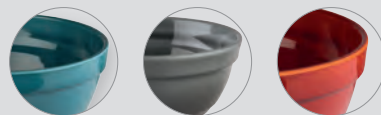

## Teller „EMMA“ plate plato assiette



	Ø cm	↑ cm	Farbe / Colour
85112	32	3,5	■
85113	32	3,5	■
85115	32	3,5	■
85116	40,5	5,5	■
85117	40,5	5,5	■
85119	40,5	5,5	■







## GN Tablett „EMMA“

GN tray  
GN bandeja  
GN plateau



	cm	↑ cm	GN	Farbe / Colour
85120	26,5 x 16,2	3	1/4	■
85121	26,5 x 16,2	3	1/4	■
85123	26,5 x 16,2	3	1/4	■
85124	32,5 x 26,5	3	1/2	■
85125	32,5 x 26,5	3	1/2	■
85127	32,5 x 26,5	3	1/2	■

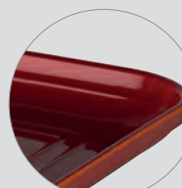
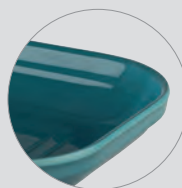
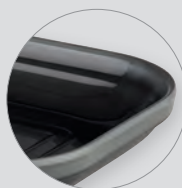

## GN Schale „EMMA“

GN bowl  
GN cuenco  
GN bol



	cm	↑ cm	ltr.	GN	Farbe / Colour
85128	26,5 x 16,2	7,5	1,5	1/4	■
85129	26,5 x 16,2	7,5	1,5	1/4	■
85131	26,5 x 16,2	7,5	1,5	1/4	■
85132	32,5 x 26,5	7,5	3,5	1/2	■
85133	32,5 x 26,5	7,5	3,5	1/2	■
85135	32,5 x 26,5	7,5	3,5	1/2	■

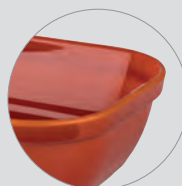
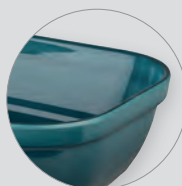

## ❄️ Cooling bowl ❄️



# NERO



85067 GN 1/1

85068 GN 1/2



85067 GN 1/1

85068 GN 1/2

## GN Tablett „NERO“

GN tray  
GN bandeja  
GN plateau



	cm	↑ cm	GN
85067	53,0 x 32,5	2,5	1/1
85068	32,5 x 26,5	2,5	1/2

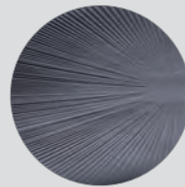
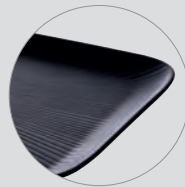

85063 Ø 21 cm

85064 Ø 26 cm

85065 Ø 33 cm

85066 Ø 42 cm

## Teller „NERO“

plate  
plato  
assiette



	Ø cm	↑ cm
85063	21	3
85064	26	3
85065	33	3,5
85066	42	3,5

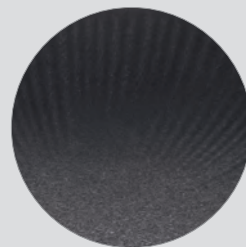



Schale „NERO“

bowl  
cuenco  
bol



	Ø cm	↑ cm	ltr.
85069	16	6,5	0,5
85070	19	8,0	0,9
85061	24	9,0	1,7

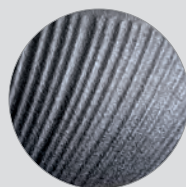
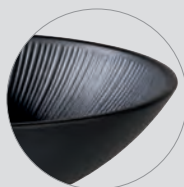

Schale „NERO“

bowl  
cuenco  
bol



	Ø cm	↑ cm	ltr.
85060	22,5	4,5	0,8
85062	30,0	7,0	2,2

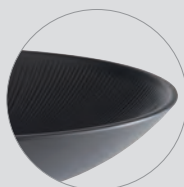

Schale „NERO“

bowl, square  
cuenco, cuadrado  
bol creux carré



	cm	↑ cm	ltr.
85071	19,5 x 19,5	8	1,5
85072	25,0 x 25,0	11	3,5

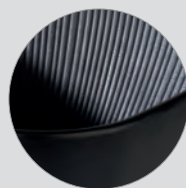
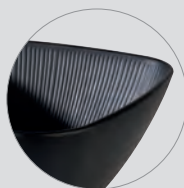





⊕ Kompatibilität / compatibility / combinación / compatibilité

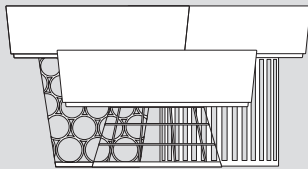

**BASKETS**  
RISERS

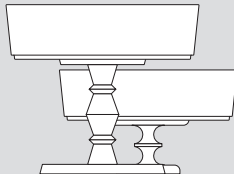

**WOOD**  
RISERS

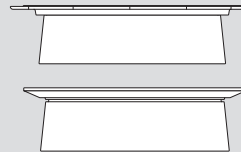

**BAKERY / WOOD**  
PLATES

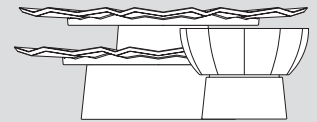

**LOTUS**  
BOWLS / PLATES



15225

15227

**GN Tablett TILES „APS+“**

GN tray  
GN bandeja  
GN plateau



	cm	↑ cm	GN	Farbe / Colour
15225	26,5 x 16,2	1,5	1/4	■
15226	32,5 x 17,5	1,5	1/3	■
15228	32,5 x 26,5	1,5	1/2	■
15227	53,0 x 16,2	1,5	2/4	■

**Passender Deckel 15348**  
matching cover 15348



15116

**GN 1/4 Schale „APS+“**

GN 1/4 bowl  
GN 1/4 cuenco  
GN 1/4 bol



	cm	↑ cm	GN	litr.	Farbe / Colour
15116	26,5 x 16,2	7	1/4	1,5	■
15117	26,5 x 16,2	9	1/4	2,5	■

**Passende Deckel / cover / tapa / couvercle**

	cm	↑ cm	GN
15348	26,5 x 16,2	1,5	1/4





**Schale, quadratisch „APS+“**

bowl, square  
cuenco cuadrado  
bol carré



	cm	↑ cm	ltr.	Farbe / Colour
15110	6,5 x 6,5	6	0,15	
15111	9,0 x 9,0	4	0,15	
15112	13,0 x 13,0	7	0,60	



**Schale, quadratisch „APS+“**

bowl, square  
cuenco cuadrado  
bol carré



	cm	↑ cm	ltr.	Farbe / Colour
15113	20,0 x 20,0	7	1,5	
15114	24,0 x 24,0	9	3,5	
15115	26,5 x 26,5	9	4,0	

**Passende Deckel / cover / tapa / couvercle**

	cm	↑ cm	
15345	20 x 20	1,5	
15346	24 x 24	1,5	
15347	26,5 x 26,5	1,5	



**Schale, rund „APS+“**

bowl, round  
cuenco, redondo  
bol rond



	Ø cm	↑ cm	ltr.	Farbe / Colour
15100	6,5	6	0,15	
15101	9,0	4	0,15	
15102	13,0	7	0,60	



**Schale, rund „APS+“**

bowl, round  
cuenco, redondo  
bol rond



	Ø cm	↑ cm	ltr.	Farbe / Colour
15600	6,5	6	0,15	
15601	6,5	6	0,15	
15603	9,0	4	0,15	
15604	9,0	4	0,15	
15605	9,0	4	0,15	



Schale, rund „ASIA PLUS“

bowl, round  
cuenco, redondo  
bol rond



	Ø cm	↑ cm	ltr.	Farbe / Colour
15105	20,0	7	1,5	—
15106	24,0	9	2,7	—
15108	32,5	9	4,0	—

Passende Deckel / cover / tapa / couvercle



	Ø cm	↑ cm
15340	16	1,5
15341	20	1,5
15342	24	1,5
15343	26,5	1,5
15344	32,5	1,5



GN 1/4 Schale „ASIA PLUS“

GN 1/4 bowl  
GN 1/4 cuenco  
GN 1/4 bol



	cm	↑ cm	GN	ltr.	Farbe / Colour
15219	26,5 x 16,2	7	1/4	1,5	—
15220	26,5 x 16,2	9	1/4	2,5	—
15234	26,5 x 16,2	7	1/4	1,5	—
15235	26,5 x 16,2	9	1/4	2,5	—



Passende Deckel / cover / tapa / couvercle

	cm	↑ cm	GN
15348	26,5 x 16,2	1,5	1/4



Schale „ASIA PLUS“

bowl  
cuenco  
bol



	cm	↑ cm	ltr.	Farbe / Colour
15215	13,0 x 13,0	7	0,6	
15216	20,0 x 20,0	7	1,5	
15217	24,0 x 24,0	9	3,5	
15218	26,5 x 26,5	9	4,0	
15232	20,0 x 20,0	7	1,5	
15233	26,5 x 26,5	9	4,0	

Passende Deckel / cover / tapa / couvercle



	cm	↑ cm		
15345	20 x 20	1,5		
15346	24 x 24	1,5		
15347	26,5 x 26,5	1,5		



Schale „ASIA PLUS“

bowl  
cuenco  
bol



	Ø cm	↑ cm	ltr.	Farbe / Colour
15230	20,0	7	1,5	
15231	32,5	9	4,0	

Passende Deckel / cover / tapa / couvercle



	Ø cm	↑ cm		
15341	20	1,5		
15344	32,5	1,5		



Schale „ASIA PLUS“

bowl  
cuenco  
bol



	Ø cm	↑ cm	ltr.	Farbe / Colour
15200	6,5	6	0,15	
15201	9,0	4	0,15	



Schale „ASIA PLUS“

bowl  
cuenco  
bol



	cm	↑ cm	ltr.	Farbe / Colour
15204	6,5 x 6,5	6	0,15	
15205	9,0 x 9,0	4	0,15	



GN Tablett „ASIA PLUS“

GN tray  
GN bandeja  
GN plateau



	cm	↑ cm	GN	Farbe / Colour
15449	53,0 x 32,5	3	1/1	
15450	32,5 x 26,5	3	1/2	
15451	32,5 x 17,6	3	1/3	
15452	26,5 x 16,2	3	1/4	
15453	35,4 x 32,5	3	2/3	
15454	53,0 x 16,2	3	2/4	
15455	53,0 x 32,5	3	1/1	
15456	32,5 x 26,5	3	1/2	
15457	32,5 x 17,6	3	1/3	
15458	26,5 x 16,2	3	1/4	
15460	53,0 x 16,2	3	2/4	

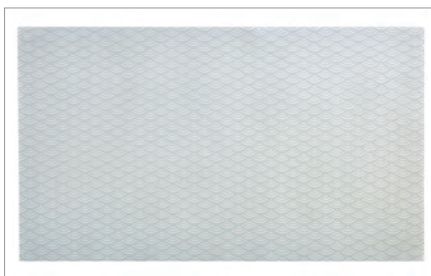

Antirutschmatte „ASIA PLUS“

non slip mat  
esterilla antideslizante  
tapis antidérapant



	cm	fits to
15497	51 x 31,0	15449, 15455
15499	31 x 25,5	15450, 15456

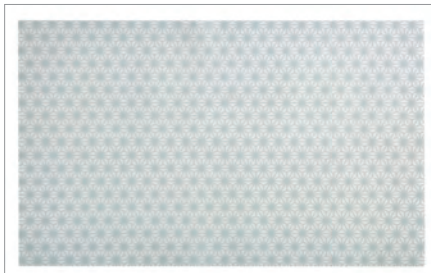

Antirutschmatte „ASIA PLUS“

non slip mat  
esterilla antideslizante  
tapis antidérapant



	cm	fits to
15498	51 x 31,0	15449, 15455
15500	31 x 25,5	15450, 15456

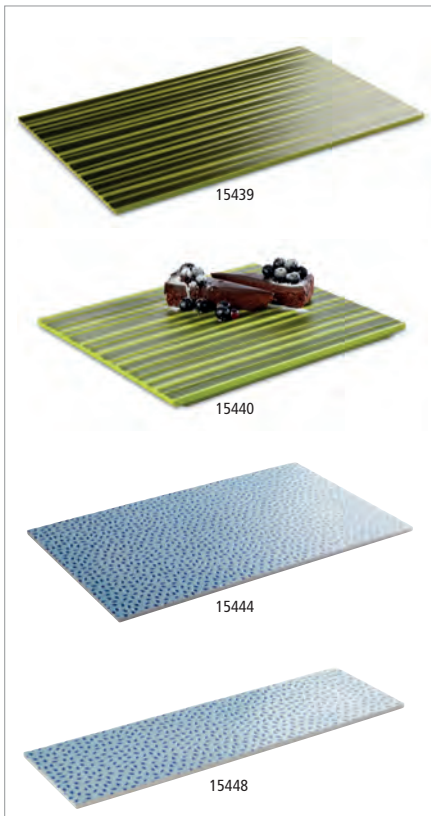

GN Tablett „ASIA PLUS“

GN tray  
GN bandeja  
GN plateau



	cm	↑ cm	GN	Farbe / Colour
15439	53,0 x 32,5	1,5	1/1	
15440	32,5 x 26,5	1,5	1/2	
15443	53,0 x 16,2	1,5	2/4	
15444	53,0 x 32,5	1,5	1/1	
15445	32,5 x 26,5	1,5	1/2	
15448	53,0 x 16,2	1,5	2/4	







ASIA+



Schale „ASIA PLUS“

bowl  
cuenco  
bol



	Ø cm	↑ cm	ltr.	Farbe / Colour
15400	7,5	3,5	0,06	White
15401	9,5	4,5	0,13	White
15402	13,0	5,5	0,35	White
15403	16,0	7,0	0,60	White
15404	20,0	8,0	1,10	White
15405	24,0	9,5	2,20	White
15406	26,5	11,0	3,00	White
15407	32,5	12,5	5,40	White
15408	7,5	3,5	0,06	White/Blue
15409	9,5	4,5	0,13	White/Blue
15410	13,0	5,5	0,35	White/Blue
15411	16,0	7,0	0,60	White/Blue
15412	20,0	8,0	1,10	White/Blue
15413	24,0	9,5	2,20	White/Blue
15414	26,5	11,0	3,00	White/Blue
15415	32,5	12,5	5,40	White/Blue
15416	7,5	3,5	0,06	Black/Red
15417	9,5	4,5	0,13	Black/Red
15418	13,0	5,5	0,35	Black/Red
15419	16,0	7,0	0,60	Black/Red
15420	20,0	8,0	1,10	Black/Red
15421	24,0	9,5	2,20	Black/Red
15422	26,5	11,0	3,00	Black/Red
15423	32,5	12,5	5,40	Black/Red



Deckel mit Löffelaussparung

cover with notched for spoons  
tapa con espacio para la cuchara  
couvre-cle avec encoche pour la louche



	Ø cm	↑ cm	fits to
15340	16,0	1,5	15403, 15411, 15419
15341	20,0	1,5	15404, 15412, 15420
15342	24,0	1,5	15405, 15413, 15421
15343	26,5	1,5	15406, 15414, 15422
15344	32,5	1,5	15407, 15415, 15423



Teller „ASIA PLUS“  
plate  
plato  
assiette



	Ø cm	↑ cm	Farbe / Colour
15424	11,0	2	
15425	16,0	2	
15427	24,0	2	

	Ø cm	↑ cm	Farbe / Colour
15429	11,0	2	
15430	16,0	2	
15432	24,0	2	

	Ø cm	↑ cm	Farbe / Colour
15434	11,0	2	
15435	16,0	2	
15437	24,0	2	









**Bento Box „ASIA PLUS“**

original APS melamin MAX 70°C

	Ø cm	↑ cm	ltr.	Farbe / Colour
15461	7,5	3,0	0,04	White
15462	7,5	6,5	0,13	White



	Ø cm	↑ cm	ltr.	Farbe / Colour
15467	7,5	3,0	0,04	Black/Red
15468	7,5	6,5	0,13	Black/Red



	cm	↑ cm	ltr.	Farbe / Colour
15473	7,5 x 7,5	3,0	0,05	White
15474	7,5 x 7,5	6,5	0,16	White
15479	15,5 x 15,5	3,0	0,19	White



	cm	↑ cm	ltr.	Farbe / Colour
15485	7,5 x 7,5	3,0	0,05	Black/Red
15486	7,5 x 7,5	6,5	0,16	Black/Red
15491	15,5 x 15,5	3,0	0,19	Black/Red



	cm	↑ cm	ltr.	Farbe / Colour
15475	15,5 x 7,5	3,0	0,10	White
15477	15,5 x 9,5	3,0	0,15	White
15483	25,0 x 15,5	3,0	0,30	White



	cm	↑ cm	ltr.	Farbe / Colour
15487	15,5 x 7,5	3,0	0,10	Black/Red
15495	25,0 x 15,5	3,0	0,30	Black/Red



ASIA+





**Buffetständer / -korb „ASIA PLUS“**

buffet stand / basket  
soporte para buffet / cestas  
présentoir buffet / corbeilles



	∅ cm	↑ cm	Farbe / Colour
15507	15	10,5	■
15508	21	10,5	■
15509	21	20	■



**GN Buffetständer „ASIA PLUS“**

GN buffet stand  
GN soporte para buffet  
GN présentoir buffet



	cm	GN	Farbe / Colour
15501	53,0 x 32,5 / 53,0 x 16,2	1/1 / 2/4	■
15502	32,5 x 26,5 / 26,5 x 16,2	1/2 / 1/4	■
15503	32,5 x 17,5 / 35,4 x 32,5	1/3 / 2/3	■
15504	53,0 x 32,5 / 53,0 x 16,2	1/1 / 2/4	■
15505	32,5 x 26,5 / 26,5 x 16,2	1/2 / 1/4	■
15506	32,5 x 17,5 / 35,4 x 32,5	1/3 / 2/3	■

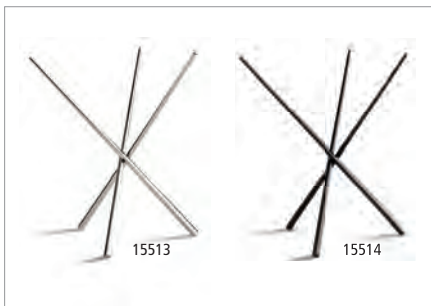

**Buffetständer „ASIA PLUS“**

buffet stand  
soporte para buffet  
présentoir buffet



	∅ cm	↑ cm	Farbe / Colour
15513	20,5 / 16,5	20	stainless steel
15514	20,5 / 16,5	20	■



**Korb / Ständer „ASIA PLUS“**

basket / riser  
cesta / soporte  
corbeille / support



	∅ cm	↑ cm	Farbe / Colour
15320	10,5 / 8	8	■
15324	10,5 / 8	8	■
15322	10,5 / 8	8	■



# HANOI



Die ansteigenden Schalenformen erzeugen eine asiatische Marktopitik und verleihen Ihrem Buffet durch die gewobene Oberflächenstruktur eine natürliche Authentizität.

The rising bowl forms create an Asian market look and give your buffet a natural authenticity through the woven surface structure.

La forma creciente de los cuencos crea un look de un mercado asiático y le dá a su buffet una autenticidad natural gracias a la estructura de la superficie tejida.

La forme croissante de bols crée un aspect visuel d'une marché asiatique et donne à votre buffet une authenticité naturelle à travers la structure de surface tissée.



## Schale / Teller „HANOI“

bowl / plate  
cuenco / plato  
bol / assiette



	Ø cm	↑ cm
84725	25,5	3,0 / 6,5
84726	30,0	3,5 / 7,5
84727	35,5	4,0 / 9,0



# BLUE OCEAN



Da geht die Sonne auf!  
Maritime Aquatöne,  
Farbverläufe und klassisches  
Blau-Weiß erinnert an eine  
griechische Taverne in der  
Ägäis.

The sun is rising!  
Maritime aqua tones,  
gradients and classic blue  
and white reminiscent of  
a Greek tavern in the  
Aegean Sea.

¡Está saliendo el sol! Los tonos marinos, los degradados de color, el clásico azul y blanco recuerdan a una taberna griega en el mar Egeo.

Le soleil se lève! Les tons maritimes, les dégradés de couleurs, le bleu et le blanc classiques, tout rappellent une taverne grecque de la mer Égée.

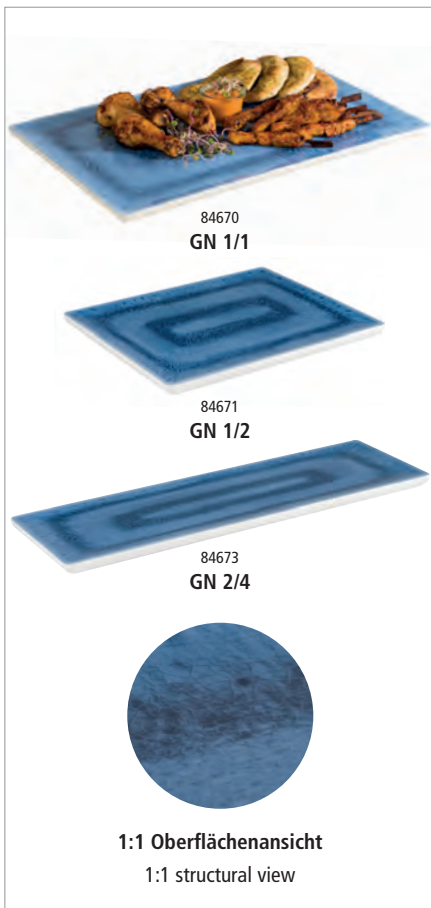

## GN Tablett „BLUE OCEAN“

GN tray  
GN bandeja  
GN plateau



	cm	↑ cm	GN
84670	53,0 x 32,5	2	1/1
84671	32,5 x 26,5	2	1/2
84672	32,5 x 17,6	2	1/3
84673	53,0 x 16,2	2	2/4



mit Antirutschfüßchen  
with non-slip feet







Tablett „BLUE OCEAN“

tray  
bandeja  
plateau



	cm	↑ cm
84676	48 x 35,5	3

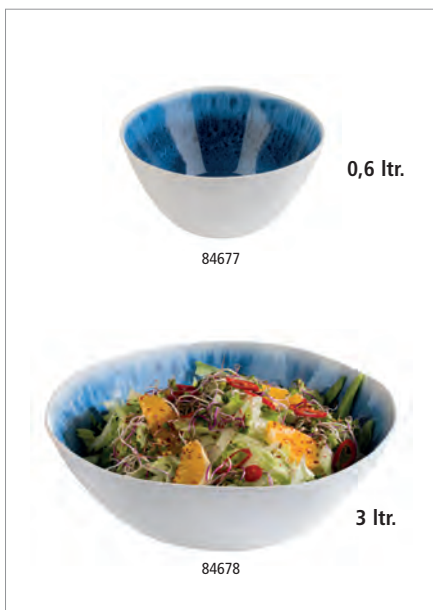

0,6 ltr.

84677

Schale „BLUE OCEAN“

bowl  
cuenco  
bol



	Ø cm	↑ cm	ltr.
84677	15	7,5	0,6

	Ø cm	↑ cm	ltr.
84678	30,5	9	3



84674

84675

Teller „BLUE OCEAN“

plate  
plato  
assiette



	Ø cm	↑ cm
84674	21,5	2
84675	26,5	2



84678



84677



84678



Beim Anblick der mediterranen Melamin Serie ARABESQUE bekommt man direkt Lust auf eine Tapas-Party. Mit seinem spanischen Charme und den wundervoll ausgearbeiteten Details holen Sie sich ein Stück Spanien auf Ihr Buffet.

When looking at the Mediterranean melamine series ARABESQUE, the longing for a tapas party resurfaces. With its Spanish charm and the beautifully crafted details, you get a slice of Spain on your buffet.

Al ver la serie mediterránea de melamina ARABESQUE, se obtiene un dicho antojo por una fiesta de tapas. Con su encanto español y los detalles bellamente elaborados, obtenga una rebanada de España en su buffet.

En regardant la série de mélamine méditerranéenne ARABESQUE, vous obtenez envie de préparer une fête de tapas. Avec son charme espagnol et les détails joliment ouvrés, vous aurez une tranche d'Espagne sur votre buffet.



### GN Tablett „ARABESQUE“

GN tray  
GN bandeja  
GN plateau



	cm	↑ cm	GN
84680	53,0 x 32,5	2	1/1
84681	32,5 x 26,5	2	1/2
84682	32,5 x 17,6	2	1/3
84683	53,0 x 16,2	2	2/4







84687



84688



84689



84690

## Schale „ARABESQUE“

bowl  
cuenco  
bol

	∅ cm	↑ cm	litr.
84687	10,0	6,0	0,2
84688	15,5	8,0	0,8
.....			
	∅ cm	↑ cm	litr.
84689	20,5	5,5	1,1
84690	31,0	9,0	3,0



1:1 Oberflächenansicht

1:1 structural view



## Teller „ARABESQUE“

plate  
plato  
assiette

	cm	↑ cm
84686	38 x 15,5	2



84684



84685

## Teller „ARABESQUE“

plate  
plato  
assiette

	∅ cm	↑ cm
84684	21,5	2
84685	26,5	2



Teller „BAMBOO“  
plate  
plato  
assiette



	cm	↑ cm
84809	24 x 17	3,5



Schale „BAMBOO“  
bowl  
cuenco  
bol



	cm	↑ cm	ltr.
84815	10,5 x 10,0	3,0	0,03
84816	17,5 x 15,5	5,5	0,2



Schale „BAMBOO“  
bowl  
cuenco  
bol



	Ø cm	↑ cm	ltr.
84819	30,5	8,5	2



Schale „BAMBOO“  
bowl  
cuenco  
bol



	cm	↑ cm	ltr.
84817	18,0 x 17,5	5,5	0,3
84818	23,0 x 22,0	7,0	0,7





Tablett „BAMBOO“

tray  
bandeja  
plateau



	cm	↑ cm
84803	10,0 x 10,0	2,0
84804	14,5 x 14,5	2,5
84805	31,0 x 10,5	2,0
84806	21,0 x 13,0	3,0
84807	24,5 x 15,5	3,0
84808	34,5 x 21,5	3,0



GN Tablett „BAMBOO“

tray  
bandeja  
plateau



	cm	↑ cm	GN
84800	53,0 x 32,5	2	1/1
84801	32,5 x 26,5	2	1/2
84802	32,5 x 17,6	2	1/3



Tablett „BAMBOO“

tray  
bandeja  
plateau



	cm	↑ cm
84811	24,5 x 15	3,5
84812	32,5 x 19	4,5



Tablett „BAMBOO“

tray  
bandeja  
plateau



	cm	↑ cm
84813	40 x 25,5	3,0
84814	53 x 34,0	3,5



Tablett „BAMBOO“

tray  
bandeja  
plateau



	cm	↑ cm
84810	34 x 13	3



# LOOPS

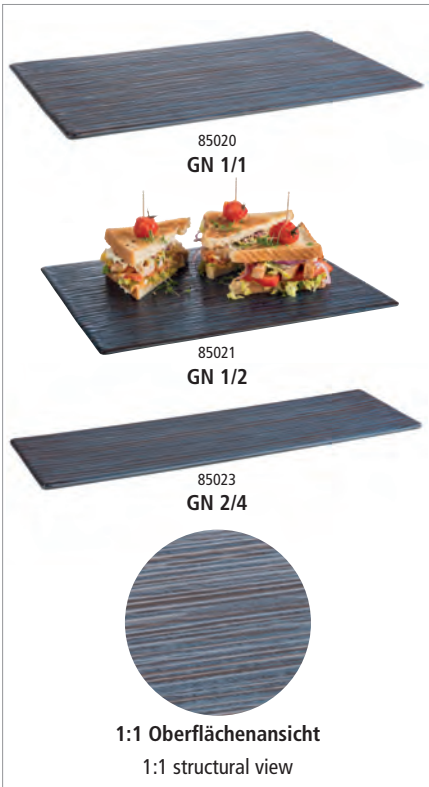

## GN Tablett „LOOPS“

GN tray  
GN bandeja  
GN plateau



	cm	↑ cm	GN
85020	53,0 x 32,5	1,5	1/1
85021	32,5 x 26,5	1,5	1/2
85022	32,5 x 17,6	1,5	1/3
85023	53,0 x 16,2	1,5	2/4



## Tablett/Sushiboard „LOOPS“

tray  
bandeja  
plateau



	cm	↑ cm
85025	23,5 x 13,5	1,5



## Teller „LOOPS“

plate  
plato  
assiette



	Ø cm	↑ cm
85027	22	2
85028	27	2



Schale „LOOPS“

bowl  
cuenco  
bol



	∅ cm	↑ cm	ltr.
85024	34 x 15,5	4	0,6



Schale „LOOPS“

bowl  
cuenco  
bol



	∅ cm	↑ cm	ltr.
85026	18	3	0,25



Schale „LOOPS“

bowl  
cuenco  
bol



	∅ cm	↑ cm	ltr.
85029	20,5	6,5	0,8
85030	31,0	8,0	2,0



Tablett „LOOPS“

tray  
bandeja  
plateau



	∅ cm	↑ cm
85031	32,0	3,5
85032	40,5	5,0



Torten- / Konditorplatte „LOOPS“

cake stand  
soporte para pastel  
présentoir à gâteaux



	∅ cm	↑ cm	fits to
85033	21,5	2,5	06519
85034	30,5	3,5	06520, 06512, 06510
85035	37,5	4,0	06521

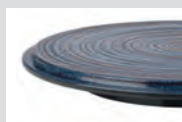



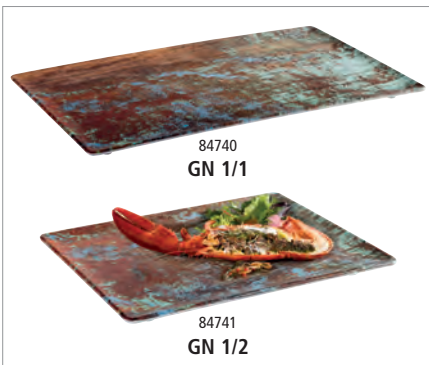

GN Tablett „AQUARIS“

GN tray  
GN bandeja  
GN plateau



	cm	↑ cm	GN	Farbe / Colour
84740	53,0 x 32,5	2	1/1	
84741	32,5 x 26,5	2	1/2	
84742	32,5 x 17,6	2	1/3	
84743	53,0 x 16,2	2	2/4	

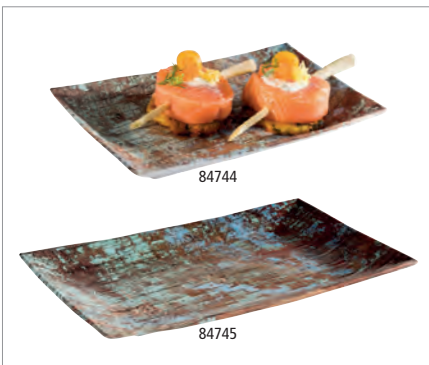

Tablett „AQUARIS“

tray  
bandeja  
plateau



	cm	↑ cm	Farbe / Colour
84744	21,0 x 13	3	
84745	34,5 x 22	3	



Teller „AQUARIS“

plate  
plato  
assiette



	Ø cm	↑ cm	Farbe / Colour
84746	26	3,5	
84747	35	3,0	

	cm	↑ cm	Farbe / Colour
84748	24,0 x 17	3,5	
84749	40,5 x 30	4,0	





Schale „COCONUT“

bowl  
cuenco  
bol



	Ø cm	↑ cm	ltr.
84990	14	6,5	0,5
84991	24	9,5	2,2



1:1 Oberflächenansicht  
1:1 structural view



Schale „ELEMENT LOOK“

bowl  
cuenco  
bol



	Ø cm	↑ cm	ltr.
84835	21,5	5,5 / 9,5	0,7
84836	26,0	7,0 / 12,5	1,45
84837	30,0	8,5 / 14,5	2,3



1,45 ltr.

84836



mit Antirutschfüßchen  
with non-slip feet  
con pies antideslizantes  
avec pieds antidérapants



**GN Tablett „IRON“**

GN tray  
GN bandeja  
GN plateau



	cm	↑ cm	GN
84884	32,5 x 26,5	2	1/2
84885	26,5 x 16,2	2	1/4
84886	53,0 x 16,2	2	2/4



**Schale „IRON“**

GN bowl  
GN cuenco  
GN bol



	cm	↑ cm	GN	ltr.
84880	32,5 x 26,5	8,5	1/2	3,5
84881	26,5 x 16,2	8,5	1/4	1,4
84882	53,0 x 16,2	8,5	2/4	3,2
84883	25,0 x 25,0	10,0	-	2,8





# STONE ART



84511

Teller „STONE ART“  
plate  
plato  
assiette



	Ø cm	↑ cm
84510	19	2
84511	25	2
84512	30	2



84509

Teller „STONE ART“  
plate  
plato  
assiette



	Ø cm	↑ cm	litr.
84509	15,5	2,5	0,15
84514	20,0	4,5	0,60



Teller „STONE ART“  
plate  
plato  
assiette



	Ø cm	↑ cm
84515	24,5	3,5



Teller „STONE ART“  
plate  
plato  
assiette



	cm	↑ cm
84517	33 x 32,5	3

# STONE ART



## Schale „STONE ART“

bowl  
cuenco  
bol



MAX  
70°C



	∅ cm	↑ cm	ltr.
84523	8	3	0,07



## Schale „STONE ART“

bowl  
cuenco  
bol



MAX  
70°C



	∅ cm	↑ cm	ltr.
84524	12	6	0,3



## Schale „STONE ART“

bowl  
cuenco  
bol



MAX  
70°C



	∅ cm	↑ cm	ltr.
84525	15	7,5	0,6



## Schale „STONE ART“

bowl  
cuenco  
bol



MAX  
70°C



	cm	↑ cm	ltr.
84526	23 x 19	6,5	0,6



## Schale „STONE ART“

bowl  
cuenco  
bol



MAX  
70°C



	cm	↑ cm	ltr.
84528	28,5 x 21	7,5	1,2



84529

## Schale „STONE ART“

bowl  
cuenco  
bol



MAX  
70°C



	cm	↑ cm	ltr.
84529	19 x 19	6,0	0,5
84530	24 x 24	6,5	1,1





GN Tablett „STONE ART“

GN tray  
GN bandeja  
GN plateau



	cm	↑ cm	GN
84519	53,0 x 32,5	1,5	1/1
84520	32,5 x 26,5	1,5	1/2
84522	53,0 x 16,2	1,5	2/4
84521	32,5 x 17,6	1,5	1/3



mit Antirutschfüßchen  
with non-slip feet  
con pies antideslizantes  
avec pieds antidérapants



GN Abdeckhaube

GN cover  
GN cubierta  
GN cloche



passend für GN Tablett, glasklarer Kunststoff, nahezu unzerbrechlich  
suitable for GN trays, clear plastic, nearly unbreakable  
apto para bandejas GN, plástico transparente, muy resistente a la rotura  
pour bacs et plateaux GN, plastique transparent, très résistant à la casse

	cm	↑ cm	✱ mm	GN
11043	32,5 x 17,6	10,5	3	1/3
11044	53,0 x 16,2	10,5	3	2/4

	cm	↑ cm	✱ mm	GN
11041	32,5 x 26,5	9,5	3	1/2
11042	53,0 x 32,5	9,5	3	1/1

# AIKO



## Schale „AIKO“

bowl  
cuenco  
bol



### Steinoptik

appearance stoneware  
su aspecto recuerda al gres  
l'aspect de la mélamine rapelle le grès

	cm	↑ cm	ltr.	Farbe / Colour
84327	26,5 x 19,5	6	0,9	■



84331

## Schale „AIKO“

bowl  
cuenco  
bol



### Steinoptik

appearance stoneware  
su aspecto recuerda al gres  
l'aspect de la mélamine rapelle le grès

	Ø cm	↑ cm	ltr.	Farbe / Colour
84329	8,0	4	0,07	■
84331	11,5	6	0,20	■



84334

84337

## Schale „AIKO“

bowl  
cuenco  
bol



### Steinoptik

appearance stoneware  
su aspecto recuerda al gres  
l'aspect de la mélamine rapelle le grès

	Ø cm	↑ cm	ltr.	Farbe / Colour
84334	16,0	7	0,6	■
84336	20,5	8	1,2	■
	Ø cm	↑ cm	ltr.	Farbe / Colour
84335	16,0	7	0,6	■
84337	20,5	8	1,2	■



Betonoberflächen auf dem Buffet für den Kontakt mit Lebensmitteln? ELEMENT macht es möglich. Bestens geeignet im modernen und urbanen Ausstattungsumfeld.

Concrete surfaces on the buffet for food contact? ELEMENT makes it possible. Ideally suited for modern and urban environments.

¿Superficies de hormigón en el buffet y tener contacto con alimentos? ELEMENT lo hace posible. Ideal para ambientes modernos y urbanos.

Des surfaces en béton sur le buffet et destinées au contact alimentaire? ELEMENT le rend possible. Idéal pour les environnements modernes et urbains.



Schale „ELEMENT“

bowl  
cuenco  
bol



	cm	↑ cm	ltr.
84825	∅ 8,0	2,0	0,01
84826	10,5 x 10,0	3,0	0,02
84820	9,0 x 7,0	3,0	0,03
84821	10,5 x 10,5	3,0	0,04
84827	17,5 x 15,5	5,5	0,18



Tablett „ELEMENT“

tray  
bandeja  
plateau



	cm	↑ cm
84822	20 x 9,5	2,5



Tablett „ELEMENT“

tray  
bandeja  
plateau



	cm	↑ cm
84824	31 x 10,5	1,5





**Tablett „ELEMENT“**

tray  
bandeja  
plateau



	cm	↑ cm
84823	22,5 x 15	3



**Schale „ELEMENT“**

bowl  
cuenco  
bol



	Ø cm	↑ cm	ltr.
84828	16	7	0,5
84829	28	12	3,0



**Schale „ELEMENT“**

bowl  
cuenco  
bol



	cm	↑ cm	ltr.
84830	19 x 19	9	1,5
84831	25 x 25	12	3,8



**GN Tablett „ELEMENT“**

GN tray  
GN bandeja  
GN plateau



	cm	↑ cm	GN
84400	53,0 x 32,5	3,5	1/1
84401	32,5 x 26,5	3,5	1/2
84402	32,5 x 17,5	3,5	1/3
84403	26,5 x 16,2	3,5	1/4
84404	53,0 x 16,2	3,5	2/4



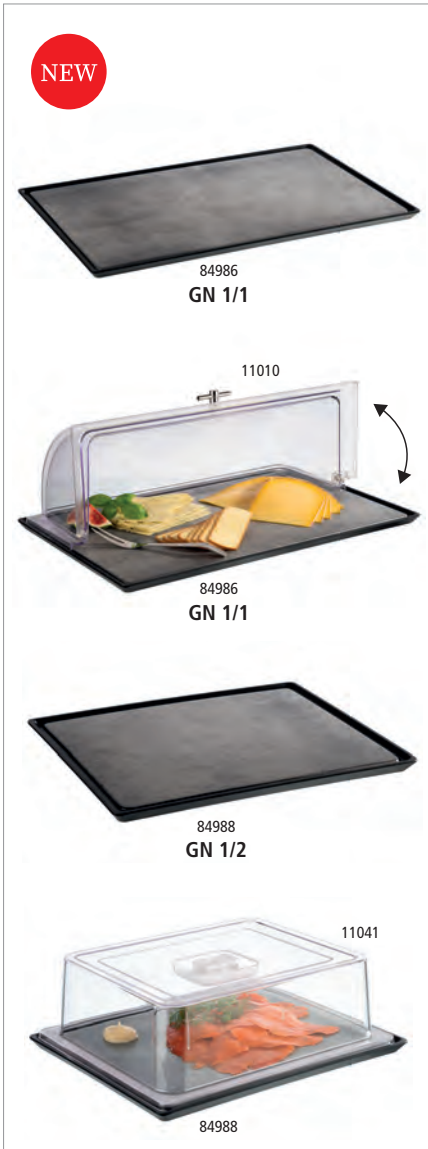

GN Tablett „ELEMENT“

GN tray  
GN bandeja  
GN plateau



	cm	↑ cm	GN
84986	53,0 x 32,5	1,5	1/1
84988	35,5 x 29,0	1,5	1/2

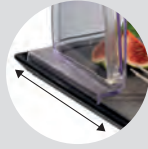

mit Antirutschrinne für Hauben  
with non-slip groove for covers

passende Hauben / suitable for cover / aptas para campana / convient pour cloche

	cm	↑ cm	GN
11010	53,0 x 32,5	19	1/1
11027	53,0 x 32,5	9,5	1/1
11041	32,5 x 26,5	9,5	1/2
11021	33,0 x 28,0	17	1/2

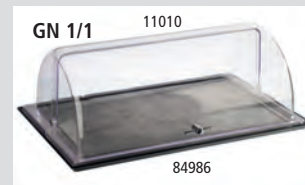

GN Tablett „BUFFET PRO“

GN tray  
GN bandeja  
GN plateau



mit Mulde für Besteckablage  
with tray for cutlery storage  
con espacio reposa cubiertos  
avec espace repose-ustensiles

	cm	↑ cm	GN
85145	53,0 x 32,5	1,5	1/1
85146	32,5 x 26,5	1,5	1/2

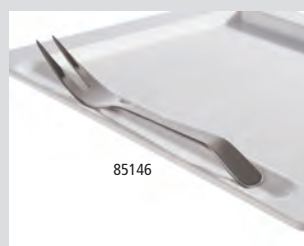

mit Mulde für Vorlagegabel  
with tray for cutlery storage



Präsentationsmöglichkeit  
presentation example

# TIMBER



## Teller „TIMBER“

plate  
plato  
assiette



	Ø cm	↑ cm
84890	15	1,5



## Teller „TIMBER“

plate  
plato  
assiette



	Ø cm	↑ cm
84891	21,5	2,5
84892	27,5	3,0



## Tablett „TIMBER“

tray  
bandeja  
plateau



	Ø cm	↑ cm
84266	35	3
84267	44	3



## Tablett „TIMBER“

tray  
bandeja  
plateau



	cm	↑ cm
84268	44 x 25	1,5



## Tablett „TIMBER“

tray  
bandeja  
plateau



	cm	↑ cm
84269	65 x 26	3



## Tablett „TIMBER“

tray  
bandeja  
plateau

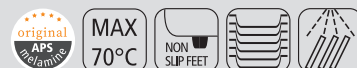

	cm	↑ cm
84256	70 x 26	3



## OAK



## Schale „OAK“

bowl  
cuenco  
bol



	cm	↑ cm
84434	11,5 x 7,0	2,5
84435	25,0 x 6,5	3,5



## GN Tablett „OAK“

GN tray  
GN bandeja  
GN plateau



Eichenoptik  
oak wood effect  
imitación madera de roble  
imitation chêne

	cm	↑ cm	GN
84720	53,0 x 32,5	1	1/1
84721	32,5 x 26,5	1	1/2
84722	32,5 x 17,6	1	1/3
84723	26,5 x 16,2	1	1/4
84724	53,0 x 16,2	1	2/4



## Tablett „OAK“

tray  
bandeja  
plateau



	Ø cm	↑ cm	Griff / handle cm
84177	30	1,5	12



## Tablett „OAK“

tray  
bandeja  
plateau



	cm	↑ cm	GN
84178	40 x 20	1,5	13
84179	48 x 20	1,5	13





# OAK LIGHT



84207  
GN 1/3



84208  
GN 1/4

84208  
GN 1/4

84209  
GN 2/4

84206  
GN 1/2

## GN Tablett „OAK LIGHT“

GN tray  
GN bandeja  
GN plateau



	cm	↑ cm	GN
84205	53,0 x 32,5	1,5	1/1
84206	32,5 x 26,5	1,5	1/2
84207	32,5 x 17,6	1,5	1/3
84208	26,5 x 16,2	1,5	1/4
84209	53,0 x 16,2	1,5	2/4



Holzoptik Eiche hell  
wood look oak light



mit Antirutschfüßchen  
with non-slip feet



84262

## Tablett „OAK LIGHT“

tray  
bandeja  
plateau



	∅ cm	↑ cm
84262	35	3
84263	44	3



## Tablett „OAK LIGHT“

tray  
bandeja  
plateau



	cm	↑ cm
84264	44 x 25	1,5



## Tablett „OAK LIGHT“

tray  
bandeja  
plateau



	cm	↑ cm
84265	65 x 26	3

# GLAMOUR



Schale „GLAMOUR“  
bowl  
cuenco  
bol



	Ø cm	↑ cm	ltr.
84365	8	3	0,05



Schale „GLAMOUR“  
bowl  
cuenco  
bol



	Ø cm	↑ cm	ltr.
84366	12	5	0,25



Schale „GLAMOUR“  
bowl  
cuenco  
bol



	Ø cm	↑ cm	ltr.
84367	15	8	0,70



Tablett „GLAMOUR“  
tray  
bandeja  
plateau



	cm	↑ cm
84377	22 x 12	3,0
84378	37 x 11	2,5

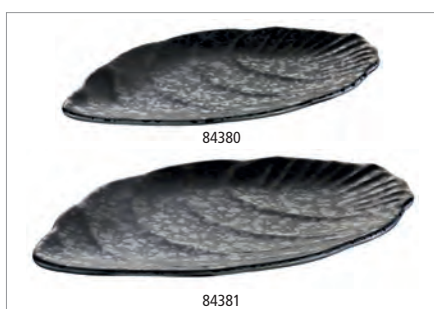

Tablett „GLAMOUR“  
tray  
bandeja  
plateau



	cm	↑ cm
84380	25,0 x 15,5	1,5
84381	30,5 x 19,0	1,5



Tablett „GLAMOUR“  
tray  
bandeja  
plateau



	cm	↑ cm
84379	30 x 11	3



# CROCKER



Servier- und Buffetartikel in Tonoptik, brauner Rand. Die Oberfläche ist innen und außen fein-matt, fühlt sich an wie Ton.

Serving and buffet items, an imitation of clay, with a brown border. The surface is inside and outside fine-matt. Feels like real clay.

Artículos de servicio y buffet, imitación barro y con borde marrón. La superficie de dentro y de fuera es de deslustre fino. Parece barro natural.

Pièces de service et pour le buffet imitation argile avec bord marron. La surface est à l'intérieur et à l'extérieur bien-matte.



**Teller „CROCKER“**  
plate  
plato  
plato  
assiette

original  
APS  
delamine

MAX  
70°C

Farbe / Colour

	cm	↑ cm	Farbe / Colour
84567	14 x 13	2,5	Light Brown
84568	14 x 13	2,5	Dark Brown



**Teller „CROCKER“**  
plate  
plato  
plato  
assiette

original  
APS  
delamine

MAX  
70°C

Farbe / Colour

	Ø cm	↑ cm	ltr.	Farbe / Colour
84575	20,5	3	0,50	Light Brown
84576	20,5	3	0,50	Dark Brown



Schale „CROCKER“

bowl  
cuenco  
bol



	Ø cm	↑ cm	ltr.	Farbe / Colour
84573	16,5	4	0,50	
84574	16,5	4	0,50	



Schale „CROCKER“

bowl  
cuenco  
bol



	Ø cm	↑ cm	ltr.	Farbe / Colour
84569	12,5	6	0,37	
84570	12,5	6	0,37	
84571	16,0	7	0,70	
84572	16,0	7	0,70	
84577	21,0	8	1,45	
84578	21,0	8	1,45	



Blattschale „CROCKER“

leaf  
fuente en forma de hoja  
plateau feuille



	cm	↑ cm	ltr.	Farbe / Colour
84579	30,5 x 10	7,5	0,17	
84580	30,5 x 10	7,5	0,17	
84581	42 x 14	9,5	0,65	
84582	42 x 14	9,5	0,65	



# FRIDA

## FRIDA'S BREAKFAST





# FRIDA

## FRIDA'S HEALTHY BUFFET





Schale „FRIDA LOCK“

bowl  
cuenco  
bol



Schalen lassen sich durch Drehmechanismus mit dem Ständer fest verbinden

bowls can be firmly connected to the stand by a turning mechanism

los cuencos se pueden conectar firmemente al soporte mediante un mecanismo giratorio

les bols peuvent être solidement reliés au présentoir au moyen d'un mécanisme rotatif

	Ø cm	↑ cm	ltr.	Farbe / Colour
84920	21,5	7/8,5	1,0	
84921	21,5	7/8,5	1,0	
84922	25,0	8/11	1,6	
84923	25,0	8/11	1,6	
84924	28,5	10/14	2,6	
84925	28,5	10/14	2,6	



Haube

cover  
campana  
cloche



	Ø cm	↑ cm	fits to
06519	21	17	84941, 84942
06520	30	22	84943, 84944
06521	36	27	84945, 84946



## Tablett / Platte „FRIDA LOCK“

tray  
bandeja  
plateau



Tabletts lassen sich durch Drehmechanismus mit dem Ständer fest verbinden

trays can be firmly connected to the stand by a turning mechanism

las bandejas se pueden conectar firmemente al soporte mediante un mecanismo giratorio

les plateaux peuvent être solidement reliés au présentoir au moyen d'un mécanisme rotatif

	Ø cm	↑ cm	Farbe / Colour
84941	22,5	1,5/2,5	
84942	22,5	1,5/2,5	
84943	31,5	1,5/2,5	
84944	31,5	1,5/2,5	
84945	38,0	1,5/2,5	
84946	38,0	1,5/2,5	



## Ständer „FRIDA LOCK“

stand  
soporte  
présentoir



	Ø cm	↑ cm	Farbe / Colour
84926	16,5	8	
84927	16,5	8	



	Ø cm	↑ cm	Farbe / Colour
84928	16,5	12	
84929	16,5	12	





# FRIDA



**Auf der kurzen und der langen Seite aufstellbar!**  
 Can stay on the short or long side!  
 Se puede colocar por la parte corta o larga!  
 Se peut installer sur le côté court ou long!

## GN Buffetständer

GN buffet stand  
 GN soporte para buffet  
 GN présentoir buffet



	cm	GN	Farbe / Colour
15504	53,0 x 32,5 / 53,0 x 16,2	1/1 / 2/4	■
15505	32,5 x 26,5 / 26,5 x 16,2	1/2 / 1/4	■



## GN Tablett „FRIDA“

GN tray  
 GN bandeja  
 GN plateau



	cm	↑ cm	GN
84601	53,0 x 32,5	2	1/1
84602	32,5 x 26,5	2	1/2
84603	26,5 x 16,2	2	1/4
84604	53,0 x 16,2	2	2/4



mit Antirutschfüßchen  
 with non-slip feet  
 con pies antideslizantes  
 avec pieds antidérapants

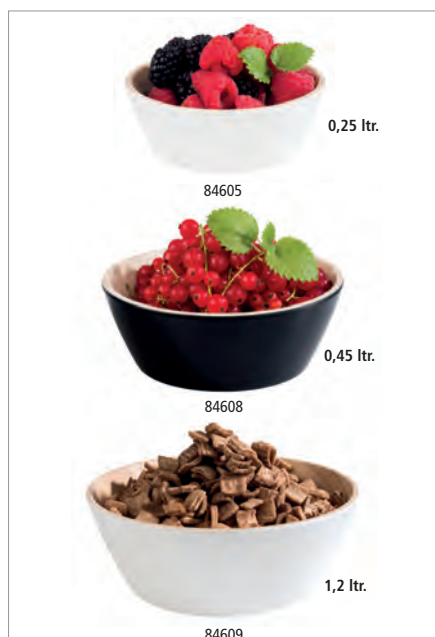

## Schale „FRIDA“

bowl  
cuenco  
bol

	Ø cm	↑ cm	ltr.	Farbe / Colour
84605	12,5	4,5	0,25	
84606	12,5	4,5	0,25	
84607	15,0	5,5	0,44	
84608	15,0	5,5	0,44	
84609	20,0	7,5	1,20	
84610	20,0	7,5	1,20	



## Schale „FRIDA“

bowl  
cuenco  
bol

	Ø cm	↑ cm	ltr.	Farbe / Colour
84611	22,0	10,5	2,2	
84612	22,0	10,5	2,2	
84613	26,5	10,5	3,4	
84614	26,5	10,5	3,4	



mit Antirutschfüßchen  
with non-slip feet  
con pies antideslizantes  
avec pieds antidérapants



## Tablett „FRIDA“

tray  
bandeja  
plateau

	cm	↑ cm	Farbe / Colour
84650	21,5 x 10,0	2,0	
84651	21,5 x 10,0	2,0	
84652	27,0 x 12,0	2,5	
84653	27,0 x 12,0	2,5	
84654	36,0 x 16,5	3,0	
84655	36,0 x 16,5	3,0	



## Schale „FRIDA“

bowl  
cuenco  
bol

	cm	↑ cm	Farbe / Colour
84615	32 x 25	3,5	
84616	32 x 25	3,5	



Schale „FRIDA“

bowl  
cuenco  
bol



	Ø cm	↑ cm	ltr.	Farbe / Colour
84930	8,5	3,5	0,1	White/Yellow
84931	8,5	3,5	0,1	Black/Yellow
84932	21,5	7,5	1,8	White/Yellow
84933	21,5	7,5	1,8	Black/Yellow
84934	30,0	9,5	4,7	White/Yellow
84935	30,0	9,5	4,7	Black/Yellow



Schale „FRIDA“

bowl  
cuenco  
bol



	cm	↑ cm	ltr.	Farbe / Colour
84936	12,5 x 12,5	4,5	0,37	White/Yellow
84937	12,5 x 12,5	4,5	0,37	Black/Yellow



Tablett „FRIDA“

tray  
bandeja  
plateau



mit 3 Absätzen, Ø 5,4 cm  
with 3 holes, Ø 5,4 cm  
con 3 agujeros, Ø 5,4 cm  
avec 3 trous, Ø 5,4 cm

	cm	↑ cm	Farbe / Colour
84938	30 x 8,5	1	White/Yellow

Anwendungsbeispiel mit Weck-Glas Nr. 82312  
example of use with Weck-glasses no. 82312



**Servierset „FRIDA“, 4-tlg.**

serving set, 4 pcs. set  
set de servicio, set de 4  
set de service, set de 4

**4-teiliges Set, bestehend aus 1 Tablett mit 3 Schalen**

4 pcs set, consisting of 1 tray with 3 bowls  
set de 4, compuesto por 1 bandeja con 3 cuencos  
set de 4, composé d'un plateau avec 3 bols

	cm	↑ cm	Farbe / Colour
84939	30 x 8,5	4,5	
84940	30 x 8,5	4,5	

**GN 1/9 Schale „FRIDA“**

GN 1/9 bowl  
GN 1/9 cuenco  
GN 1/9 bol



	Ø cm	↑ cm	ltr.	GN	Farbe / Colour
84555	17,6 x 10,8	5,5	1,5	1/9	
84556	17,6 x 10,8	5,5	1,5	1/9	

**GN 1/6 Schale „FRIDA“**

GN 1/6 bowl  
GN 1/6 cuenco  
GN 1/6 bol



	Ø cm	↑ cm	ltr.	GN	Farbe / Colour
84583	17,6 x 16,2	7,5	1,0	1/6	
84584	17,6 x 16,2	7,5	1,0	1/6	

**GN 1/4 Schale „FRIDA“**

GN 1/4 bowl  
GN 1/4 cuenco  
GN 1/4 bol

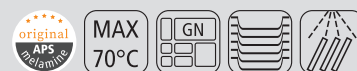

	Ø cm	↑ cm	ltr.	GN	Farbe / Colour
84586	26,5 x 16,2	7,5	1,8	1/4	
84587	26,5 x 16,2	7,5	1,8	1/4	

**GN 2/4 Schale „FRIDA“**

GN 2/4 bowl  
GN 2/4 cuenco  
GN 2/4 bol

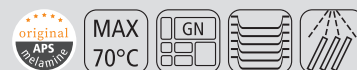

	Ø cm	↑ cm	ltr.	GN	Farbe / Colour
84564	53 x 16,2	7,5	3,65	2/4	
84565	53 x 16,2	7,5	3,65	2/4	

**GN 1/2 Schale „FRIDA“**

GN 1/2 bowl  
GN 1/2 cuenco  
GN 1/2 bol



	Ø cm	↑ cm	ltr.	GN	Farbe / Colour
84589	32,5 x 26,5	7,5	4,0	1/2	
84590	32,5 x 26,5	7,5	4,0	1/2	



**Schale „FRIDA“**  
bowl  
cuenco  
bol

original  
APS  
melamine

MAX  
70°C

	cm	↑ cm	ltr.	Farbe / Colour
84947	33,5 x 21	4	1,2	White/Yellow
84948	33,5 x 21	4	1,2	Black/Yellow

als Schütte geeignet  
suitable as a chute

Präsentationsmöglichkeit  
presentation example



**Schale „FRIDA“**  
bowl  
cuenco  
bol

original  
APS  
melamine

MAX  
70°C

	cm	↑ cm	ltr.	Farbe / Colour
84558	16,5 x 16,5	5,5	0,85	White/Yellow
84559	16,5 x 16,5	5,5	0,85	Black/Yellow



**Schale „FRIDA“**  
bowl  
cuenco  
bol

original  
APS  
melamine

MAX  
70°C

	cm	↑ cm	ltr.	Farbe / Colour
84561	25 x 25	7,5	2,65	White/Yellow
84562	25 x 25	7,5	2,65	Black/Yellow



**Schale „FRIDA“**  
bowl  
cuenco  
bol

original  
APS  
melamine

MAX  
70°C

	cm	↑ cm	ltr.	Farbe / Colour
84592	25 x 25	12	3,5	White/Yellow
84593	25 x 25	12	3,5	Black/Yellow

SAN  
KUNSTSTOFF

Deckel „PURE“ mit Löffelaussparung / cover with notched for spoons / tapa con espacio para la cuchara / couvercle avec encoche pour la louche

	cm	↑ cm	fits to
83601	25 x 25	1,5	84561, 84562, 84592, 84593

NEW

84987  
GN 1/284985  
GN 1/184985  
GN 1/1

## GN Tablett „FRIDA“

GN tray  
GN bandeja  
GN plateau

	cm	↑ cm	GN	Farbe / Colour
84987	35,5 x 29,0	1,5	1/2	
84985	53,0 x 32,5	1,5	1/1	

11021  
84987  
GN 1/211010  
84985  
GN 1/1Präsentationsmöglichkeit  
presentation example

passende Hauben / suitable for cover / aptas para campana / convient pour cloche

	cm	↑ cm	GN
11010	53,0 x 32,5	19,0	1/1
11042	53,0 x 32,5	9,5	1/1
11021	33,0 x 28,0	17,0	1/2

mit Antirutschrinne für Hauben  
with non-slip groove for covers

84595

## GN 1/4 Tablett „FRIDA“

GN 1/4 tray  
GN 1/4 bandeja  
GN 1/4 plateau

	cm	↑ cm	Farbe / Colour
84595	26,5 x 16,2	3	
84596	26,5 x 16,2	3	



84599

## Tablett „FRIDA“

tray  
bandeja  
plateau

	cm	↑ cm	Farbe / Colour
84598	35,5 x 26,0	3	
84599	35,5 x 26,0	3	



# SLATE



Die schwarzen Melaminplatten überzeugen mit ihrem edlen und schlichten Schieferlook und einer rauhen Oberfläche.

The black melamine trays convince with their noble and simple slate look and a rough surface.

Las bandejas de melamina negras convencen por su aspecto de pizarra elegante y discreto y una superficie áspera.

Les plateaux en mélamine noirs convainquent grâce au aspect de l'ardoise élégant et discret et une surface rugueuse.



## GN Tablett „SLATE“

GN tray  
GN bandeja  
GN plateau



	cm	↑ cm	GN
83955	53,0 x 32,5	1	1/1
83956	32,5 x 26,5	1	1/2
83957	32,5 x 17,6	1	1/3
83958	26,5 x 16,2	1	1/4
83971	53,0 x 16,2	1	2/4



## GN Tablett „SLATE“

GN tray  
GN bandeja  
GN plateau



	cm	↑ cm	GN
83981	53 x 32,5	1,5	1/1



## GN Tablett „SLATE“

GN tray  
GN bandeja  
GN plateau



massive Metallgriffe verchromt inkl. fest verschraubten 4 cm Distanzstücken  
chrome plated handles, incl. mounted 4 cm distance pillars  
asas cromadas, incluye distanciadores a 4 cm  
poignées chromées, distance approx. 4 cm

	cm	↑ cm	GN
83980	53 x 32,5	6	1/1



**Torten- / Konditorplatte „SLATE“**

cake stand  
soporte para pastel  
présentoir à gâteaux



Rand fixiert die Haube, mit Antirutsch-Füßchen

carved edge fixes the cover, with non-slip feet

ranura para fijar bien la campana, con pies antideslizantes

bord rainuré pour maintenir ferme la cloche, avec pieds antidérapants

	Ø cm	↑ cm
85046	21,5	2,5
85047	30,5	3,5
85048	37,5	4

**Frischhalte- Haube / cover / campana / cloche**

	Ø cm	↑ cm	fits to
06519	21	17	85046
06520	30	22	85047
06521	36	27	85048

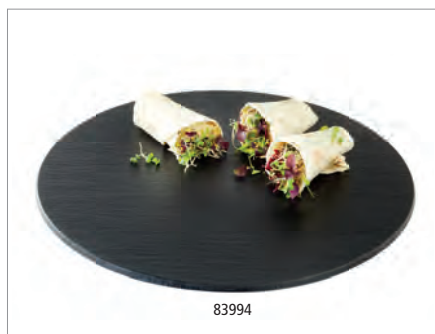

**Tablett „SLATE“**

tray  
bandeja  
plateau



	Ø cm	↑ cm
83992	30	1
83994	40	1



**Schale „SLATE“**

bowl  
cuenco  
bol



	cm	↑ cm	ltr.
84244	19 x 19	9	1,5
84245	25 x 25	12	3,8

Deckel „PURE“ mit Löffelaussparung / cover with notched for spoons

tapa con espacio para la cuchara / couvercle avec encoche pour la louche

	cm	↑ cm	fits to
83600	19 x 19	1,5	84244
83601	25 x 25	1,5	84245

# SLATE ROCK



## Tablett „SLATE-ROCK“

tray  
bandeja  
plateau



Die schwarzen Melaminplatten überzeugen mit ihrem Schieferlook  
 The black melamine trays convince with their slate look  
 Las bandejas de melamina negras convencen por su aspecto de pizarra  
 Les plateaux en mélamine noirs convainquent grâce au aspect de l'ardoise

	Ø cm	↑ cm	Griff / handle cm
84257	30	1,5	12
	cm	↑ cm	Griff / handle cm
84258	40 x 20	1,5	13
84259	48 x 20	1,5	13





**GN Tablett „ZERO“**

GN tray  
GN bandeja  
GN plateau



glatte, hochglänzende Oberfläche  
smooth and shiny surface  
superficie lisa con acabado brillante  
surface lisse et finition brillante

	cm	↑ cm	GN	Farbe / Colour
84185	53,0 x 32,5	1,5	1/1	
84186	32,5 x 26,5	1,5	1/2	
84187	32,5 x 17,6	1,5	1/3	
84188	26,5 x 16,2	1,5	1/4	
84189	53,0 x 16,2	1,5	2/4	
84195	53,0 x 32,5	1,5	1/1	
84196	32,5 x 26,5	1,5	1/2	
84197	32,5 x 17,6	1,5	1/3	
84198	26,5 x 16,2	1,5	1/4	
84199	53,0 x 16,2	1,5	2/4	



**GN Tablett „DRIFTWOOD“**

GN tray  
GN bandeja  
GN plateau



die Melaminplatten (Holzoptik) haben eine leicht wellige Oberfläche und wirken optisch wie aus Holz gefertigt  
the melamine trays (wood look) have a slightly wavy surface and look visually as made of natural wood  
las bandejas de melamine (imitación madera) tienen una superficie ligeramente ondulada y parecen estar hechas de madera natural  
les plateaux de mélamine (imitation bois) ont une surface légèrement ondulée et donnent une impression visuelle de bois naturelle

	cm	↑ cm	GN
84180	53,0 x 32,5	1,5	1/1
84181	32,5 x 26,5	1,5	1/2
84182	32,5 x 17,6	1,5	1/3
84183	26,5 x 16,2	1,5	1/4
84184	53,0 x 16,2	1,5	2/4



1:1 Oberflächenansicht  
1:1 structural view



Tablett „CIRCLE“  
plate / tray  
plato / bandeja  
assiette / plateau



	∅ cm	↑ cm	Farbe / Colour
84875	32,0	3,5	
84876	40,5	5,5	

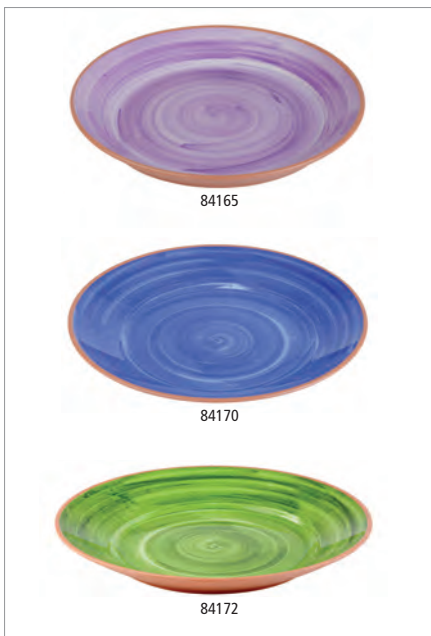

Tablett „LA VIDA“  
plate / tray  
plato / bandeja  
assiette / plateau

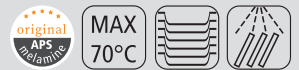

	∅ cm	↑ cm	Farbe / Colour
84165	32,0	3,5	
84168	40,5	5,5	
	∅ cm	↑ cm	Farbe / Colour
84161	32,0	3,5	
84170	40,5	5,5	
	∅ cm	↑ cm	Farbe / Colour
84171	32,0	3,5	
84172	40,5	5,5	



Eine derbe Oberflächenstruktur schafft ein natürliches Erscheinungsbild. Die schwarzen Schalenvarianten mit braunem Rand inszenieren Ihr Gericht sehr stilvoll.

A rough surface structure creates a natural appearance. The black bowls and trays with brown border stage your dishes in a very stylish way.

La estructura rugosa de la superficie crea una apariencia natural. Los diferentes cuencos negros con borde marrón ponen con mucho estilo en escena sus platos.

La structure de surface rugueuse crée une apparence naturelle. Les différents bols noirs avec rebord marron mettent élégamment en scène vos plats.



### Blattschale „MARONE“

leaf  
fuente en forma de hoja  
plateau feuille



	cm	↑ cm	ltr.
84100	25,5 x 14	5,5	0,4
84101	36,0 x 19	8,0	0,9



### Tablett „MARONE“

tray  
bandeja  
plateau



	cm	↑ cm
84104	22,5 x 15	3
84105	27,5 x 11	2



### Tablett „MARONE“

tray  
bandeja  
plateau



	cm	↑ cm
84103	14,5 x 14,5	2



### Tablett „MARONE“

tray  
bandeja  
plateau



	cm	↑ cm
84106	26,5 x 16,5	4



# MARONE



## Schale „MARONE“

bowl  
cuenco  
bol



	cm	↑ cm	ltr.
84731	16,5 x 10	5,5	0,25
84732	22,0 x 13	7,5	0,6
84733	27,5 x 19	9,0	1,4



## Teller „MARONE“

plate  
plato  
assiette



	Ø cm	↑ cm
84728	16,0	2,5
84729	20,5	2,5
84730	28,0	3,5



## Schale „MARONE“

bowl  
cuenco  
bol



	Ø cm	↑ cm	ltr.
84109	11	5,5	0,2



## Schale „MARONE“

bowl  
cuenco  
bol



	Ø cm	↑ cm	ltr.
84107	8,5	2,5	0,05
84108	11,5	3,0	0,04



Tablett „MARONE“

tray  
bandeja  
plateau



	cm	↑ cm
84117	19,5 x 9,5	2
84118	39,0 x 16,0	3



Tablett „MARONE“

tray  
bandeja  
plateau



	cm	↑ cm
84119	32,5 x 23,5	4,5



Schale „MARONE“

bowl  
cuenco  
bol



	Ø cm	↑ cm	ltr.
84174	30,5	8,5	2



Schale „MARONE“

bowl  
cuenco  
bol



	Ø cm	↑ cm	ltr.
84110	14	6,0	0,30
84111	19	8,0	0,80
84112	21	8,5	1,00
84113	24	9,5	1,40



Schale „MARONE“

bowl  
cuenco  
bol



	cm	↑ cm	ltr.
84114	23,5 x 23,5	6,5	0,70



Schale „MARONE“

bowl  
cuenco  
bol



	Ø cm	↑ cm	ltr.
84115	11	3,5	0,13
84116	14	4,0	0,20

# DARK WAVE



## GN Tablett „DARK WAVE“

GN tray  
GN bandeja  
GN plateau



	cm	↑ cm	GN
84900	53,0 x 32,5	2	1/1
84901	32,5 x 26,5	2	1/2
84902	32,5 x 17,6	2	1/3
84903	53,0 x 16,2	2	2/4



## Tablett „DARK WAVE“

tray  
bandeja  
plateau



	cm	↑ cm
84904	14 x 14	2





Tablett „DARK WAVE“

tray  
bandeja  
plateau



	cm	↑ cm
84905	23 x 10,5	1,5
84906	29 x 12,0	1,5

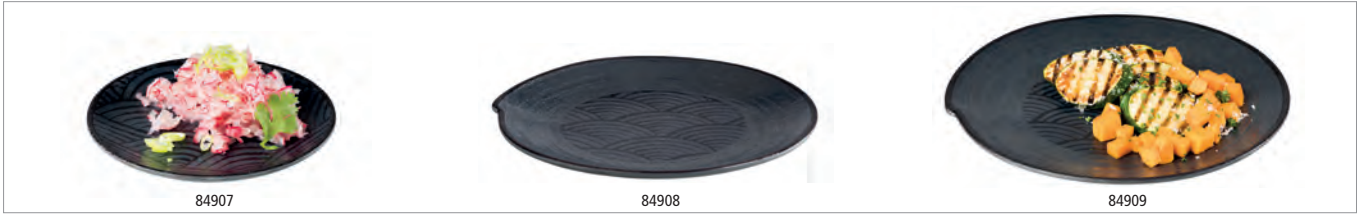

Teller „DARK WAVE“

plate  
plato  
assiette



	Ø cm	↑ cm
84907	14,5	1,5
84908	22,0	2,0
84909	27,0	2,5



Schale „DARK WAVE“

bowl  
cuenco  
bol



	Ø cm	↑ cm	litr.
84910	17,5	5,0	0,50
84911	22,5	5,0	0,75
84912	32,0	3,5	-
84913	40,5	5,5	-



Schale „DARK WAVE“

bowl  
cuenco  
bol



	cm	↑ cm	litr.
84914	18 x 18	10,0	1,6
84915	23 x 23	11,5	2,9

## ZEN



Fernöstliche Tisch- und Buffetartikel präsentiert die Serie ZEN. Die Optik entspricht dem japanischen Steingut.

The ZEN series presents Far Eastern table and buffet articles. The appearance is that of Japanese stoneware.

La colección ZEN presenta artículos de buffet y mesa para la cocina oriental. Su aspecto recuerda al gres japonés.

La collection ZEN présente des articles de buffet et de table pour la cuisine orientale. L'aspect de la mélamine rappelle le grès japonais.



Schale „ZEN“  
bowl  
cuenco  
bol



	Ø cm	↑ cm	ltr	Farbe / Colour
83929	31	8,5	2,5	■



Schale „ZEN“  
bowl  
cuenco  
bol



	Ø cm	↑ cm	ltr	Farbe / Colour
84355	22,5	12,5	0,80	■



Schale „ZEN“  
bowl  
cuenco  
bol



	cm	↑ cm	ltr	Farbe / Colour
83712	21 x 21	11	1,40	■



## Schale „ZEN“

bowl  
cuenco  
bol

	Ø cm	↑ cm	ltr.	Farbe / Colour
84348	10,0	7,0	0,08	■
84350	12,5	8,5	0,15	■
84352	16,0	10,0	0,30	■
84349	10,0	7,0	0,08	■
84351	12,5	8,5	0,15	■
84353	16,0	10,0	0,30	■

stapelbar  
stackable

## Schale „ZEN“

bowl  
cuenco  
bol

	cm	↑ cm	ltr.	Farbe / Colour
83735	25,0 x 13,5	4	0,25	■
83739	30,5 x 17,5	5	0,60	■



## Schale „ZEN“

bowl  
cuenco  
bol

	cm	↑ cm	ltr.	Farbe / Colour
83714	17,5 x 17,5	7	0,5	■
83716	17,5 x 17,5	7	0,5	■



## Schale „ZEN“

bowl  
cuenco  
bol

	cm	↑ cm	ltr.	Farbe / Colour
83725	10,5 x 10,5	3	0,06	■
83727	10,5 x 10,5	3	0,06	■

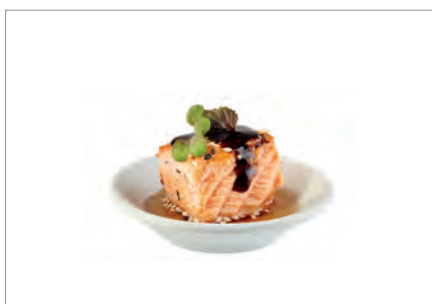

## Dipschälchen „ZEN“

dip bowl  
cuenco para dip  
bol para dip

	Ø cm	↑ cm	ltr.	Farbe / Colour
83721	8	1,5	0,03	■
83723	8	1,5	0,03	■





## Schale „ZEN“

bowl  
cuenco  
bolMAX  
70°C

	cm	↑ cm	ltr.	Farbe / Colour
83718	12 x 12	4	0,2	
83720	12 x 12	4	0,2	



## Schale „ZEN“

bowl  
cuenco  
bolMAX  
70°C

	cm	↑ cm	ltr.	Farbe / Colour
83726	13 x 11	3,5	0,1	
83728	13 x 11	3,5	0,1	



## Schale „ZEN“

bowl  
cuenco  
bolMAX  
70°C

	cm	↑ cm	ltr.	Farbe / Colour
83730	11 x 10	3	0,04	
83732	11 x 10	3	0,04	



## Schale „ZEN“

bowl  
cuenco  
bolMAX  
70°C

	cm	↑ cm	ltr.	Farbe / Colour
83722	17,5 x 15,5	5,5	0,2	
83724	17,5 x 15,5	5,5	0,2	



## Schale „ZEN“

bowl  
cuenco  
bolMAX  
70°C

	cm	↑ cm	ltr.	Farbe / Colour
83934	14,5 x 12,5	5	0,2	
83935	14,5 x 12,5	5	0,2	



## Schale „ZEN“

bowl  
cuenco  
bolMAX  
70°C

	Ø cm	↑ cm	ltr.	Farbe / Colour
83932	11,5	4	0,15	
83933	11,5	4	0,15	



## Schale „ZEN“

bowl  
cuenco  
bol



	cm	↑ cm	ltr.	Farbe / Colour
83946	9 x 7	2,5	0,05	
83947	9 x 7	2,5	0,05	



## Schale „ZEN“

bowl  
cuenco  
bol



	cm	↑ cm	Farbe / Colour
83948	14 x 9	2,5	
83949	14 x 9	2,5	



## Tablett / Teller „ZEN“

tray / plate  
bandeja / plato  
plateau / assiette



	Ø cm	↑ cm	Farbe / Colour
83940	28	3	
83941	28	3	



## Tablett „ZEN“

tray  
bandeja  
plateau



	cm	↑ cm	Farbe / Colour
83734	23,5 x 23	5,5	
83736	23,5 x 23	5,5	



## Tablett / Sushiboard „ZEN“

tray / sushiboard  
bandeja para sushi  
plateau sushi



	cm	↑ cm	Farbe / Colour
83742	22,5 x 9,5	3	
83744	22,5 x 9,5	3	



## Tablett / Sushiboard „ZEN“

tray / sushiboard  
bandeja para sushi  
plateau sushi



	cm	↑ cm	Farbe / Colour
83738	22 x 12	3	
83740	22 x 12	3	

# FUSION



Die Oberflächen der Serie FUSION sind innen hoch glänzend und außen mattiert. Das besondere Design beansprucht höchste Aufmerksamkeit und bringt Speisen optimal zur Geltung. Die Speisen werden noch mehr in den Blickpunkt gerückt.

The surfaces of the FUSION series have a mirror shiny inside and a matte outside. The unique design demands the utmost attention. The food moves even more in the focus.

Las superficies de la serie FUSION tienen un interior brillante y un exterior mate. El diseño único exige la máxima atención. Los platos reciben un enfoque aún mayor.

Les surfaces de la série FUSION sont brillantes à l'intérieur et mates à l'extérieur. Le design spéciale exige la plus grande attention. Les plats sont mise encore plus dans le centre de l'attention.

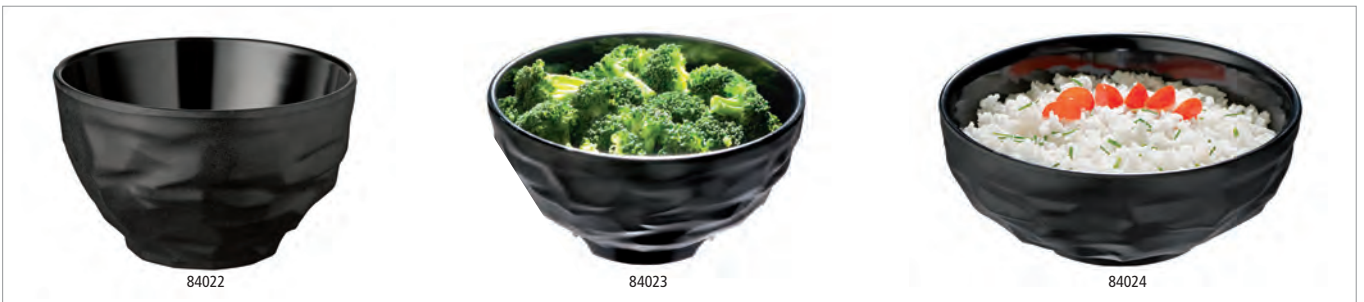

## Schale „FUSION“

bowl  
cuenco  
bol



	Ø cm	↑ cm	ltr.
84022	11	7,0	0,3
84023	17	8,5	1,0
84024	20	8,0	1,2



## Tablett „FUSION“

tray  
bandeja  
plateau



	cm	↑ cm
84025	23,5 x 7,5	2



# SINUS



84231

Charakterstark und mit dem Anspruch an Funktionalität und Design präsentiert sich die Buffetserie SINUS. Die großzügigen Flächen für die Speisenpräsentation sind ausdrucksstark eingefasst und gewährleisten ein optimales Handling.

The SINUS buffet series is characterful and with a high standard of functionality and design. The spacious areas for the food presentation are expressively enclosed and ensure optimal handling in everyday dining.

La serie de buffet SINUS demuestra un carácter fuerte y tiene un alto nivel de funcionalidad y diseño. Las áreas espaciales para la presentación de la comida son expresivamente enmarcadas y aseguran un manejo óptimo en la gastronomía.

La série de buffet SINUS est pleine de caractère et avec un haut niveau de fonctionnalité et de design. Les zones spacieuses pour la présentation de la nourriture sont expressivement encadrées et assurent une maniabilité optimale dans la restauration.



GN 1/1

GN 2/4

## GN Tablett „SINUS“

GN tray  
GN bandeja  
GN plateau



	cm	↑ cm	GN	Farbe / Colour
84230	53 x 32,5	2	1/1	White
84231	53 x 16,2	2	2/4	White
84260	53 x 32,5	2	1/1	Black
84261	53 x 16,2	2	2/4	Black



1,5 ltr.

84232



## Schale „SINUS“

bowl  
cuenco  
bol



	cm	↑ cm	ltr.
84229	10,5 x 10,5	4,0	0,1
84232	21,0 x 21,0	9,0	1,5
84233	25,0 x 25,0	11,0	2,4
84234	28,5 x 28,5	12,5	3,5

# HALFTONE



## Fingerfood Löffel „HALFTONE“

party spoon  
cuchara party  
cuillère party



MAX  
70°C



	Ø cm	↑ cm	Farbe / Colour	VE / unit
84158	5,5	7	■ ■	24



## Fingerfood Löffel „HALFTONE“

party spoon  
cuchara party  
cuillère party



MAX  
70°C



	cm	↑ cm	Farbe / Colour	VE / unit
84128	14,5 x 4,5	4,5	■ ■	12



## Tablett „HALFTONE“

tray  
bandeja  
plateau



MAX  
70°C



	cm	↑ cm
84124	20,5 x 12,5	3
84125	24,5 x 15,0	3



## Tablett „HALFTONE“

tray  
bandeja  
plateau



MAX  
70°C



	cm	↑ cm
84126	29 x 18	4



Schale „HALFTONE“

bowl  
cuenco  
bol



	Ø cm	↑ cm	litr.	VE / unit
84217	8	4	0,1	12



84130

84134

Schale „HALFTONE“

bowl  
cuenco  
bol



	cm	↑ cm	litr.
84130	11,5 x 7,0	4,0	0,05
84131	14,0 x 8,0	4,5	0,10
84132	15,0 x 9,5	5,0	0,15
84133	17,5 x 13,5	6,5	0,35
84134	24,0 x 17,5	7,5	0,8



84136

Schale „HALFTONE“

bowl  
cuenco  
bol



	Ø cm	↑ cm	litr.
84135	16,5	7,5	0,65
84136	19,0	8,5	1,00

# PADELLA



85150

85151



85150

85151

Schale „PADELLA“

bowl  
cazuelita  
plat 2 anses „cocotte“



	Ø cm	↑ cm	litr.	Griff / handle cm
85150	21	9	1,5	5 x 3,5
85151	28	9	3,0	5 x 3,5



stapelbar und rutschfest  
stackable and nonslip



Detailansicht  
close up view



# TAO



## Schale, rund „TAO“

bowl, round  
cuenco, redondo  
bol, rond



	cm	↑ cm	ltr.	Farbe / Colour
83648	10,5 x 10,0	6,5 / 3,0	0,07	White
83651	13,5 x 12,5	8,5 / 4,0	0,15	White
83654	17,0 x 16,0	10,5 / 4,5	0,3	White
83649	10,5 x 10,0	6,5 / 3,0	0,07	Black
83652	13,5 x 12,5	8,5 / 4,0	0,15	Black
83655	17,0 x 16,0	10,5 / 4,5	0,3	Black



## Schale, quadratisch „TAO“

bowl, square  
cuenco, cuadrado  
bol creux carré



	cm	↑ cm	ltr.	Farbe / Colour
83642	30,5 x 30,5	10	3,3	White
83643	30,5 x 30,5	10	3,3	Black



## Schale, rechteckig „TAO“

bowl, rectangular  
cuenco, rectangular  
bol creux rectangulaire



	cm	↑ cm	ltr.	Farbe / Colour
83639	32,5 x 17,5	10	1,8	White
83640	32,5 x 17,5	10	1,8	Black

# APART



## GN Tablett „APART“

GN tray  
GN bandeja  
GN plateau



	cm	↑ cm	GN
83828	53,0 x 32,5	2,5	1/1
83830	32,5 x 26,5	2,5	1/2
83832	32,5 x 17,6	2,5	1/3



## Tablett „APART“

tray  
bandeja  
plateau



	cm	↑ cm
83834	23,0 x 23,0	2,5
83836	33,0 x 33,0	2,5



## Schale „APART“

bowl  
cuenco  
bol



	∅ cm	↑ cm	ltr.
83800	6,5	3,0	0,045



## Schale „APART“

bowl  
cuenco  
bol



	cm	↑ cm	ltr.
83808	6,6 x 6,6	3,0	0,05
83810	10 x 10	4,5	0,17
83812	15 x 15	6,5	0,5
83814	20 x 20	9,0	1,6



## GN 2/4 Schale „APART“

GN 2/4 bowl  
GN 2/4 cuenco  
GN 2/4 bol



	cm	↑ cm	ltr.	GN
83826	53,0 x 16,2	6,5	3	2/4

# GLOBAL BUFFET

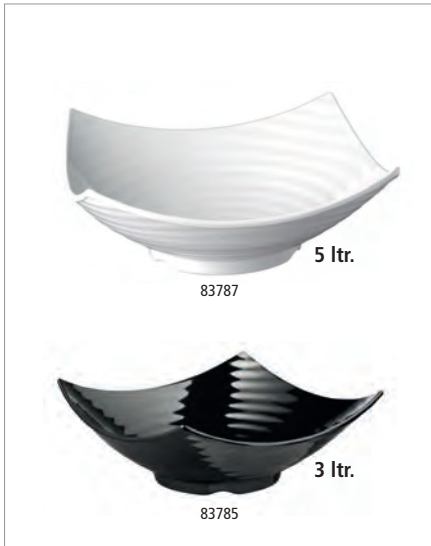

## Schale „GLOBAL BUFFET“

bowl  
cuenco  
bol



	cm	↑ cm	ltr.	Farbe / Colour
83785	32,5 x 32,5	12,0	3,0	■
83786	35,0 x 35,0	12,5	3,5	■
83787	40,0 x 40,0	13,5	5,0	■
84785	32,5 x 32,5	12,0	3,0	■
84786	35,0 x 35,0	12,5	3,5	■
84787	40,0 x 40,0	13,5	5,0	■



## Schale „GLOBAL BUFFET“

bowl  
cuenco  
bol



	cm	↑ cm	ltr.	Farbe / Colour
84464	35,5 x 31,5	14,0	2,5	■
84466	46,0 x 40,0	18,5	5,5	■



## Schale „GLOBAL BUFFET“

bowl  
cuenco  
bol



	cm	↑ cm	ltr.	Farbe / Colour
83799	25,5 x 25,5	13,0	3,0	■
83788	32,0 x 32,0	16,5	4,5	■
83789	35,0 x 35,0	17,0	6,0	■
83790	40,0 x 40,0	17,5	8,0	■



## Schale „GLOBAL BUFFET“

bowl  
cuenco  
bol



die Melaminschale wirkt optisch wie der Naturstein Granit  
 the melamine bowl looks visually as made of natural granit stone  
 el cuenco de melamina parece estar hecho de granito natural  
 le bol de mélamine donne une impression visuelle de granit naturel

	cm	↑ cm	ltr.	Farbe / Colour
84387	36 x 36	11	3,5	■





3,3 ltr.

Schale „GLOBAL BUFFET“

bowl  
cuenco  
bol



	cm	↑ cm	ltr.	Farbe / Colour
84462	44 x 25	20	3,3	_____



84200 1,0 ltr.

Schale „LEAF“

bowl  
cuenco  
bol



	cm	↑ cm	ltr.	Farbe / Colour
84200	42 x 19,5	6,5	1,0	_____
84202	50 x 23,0	7,5	1,5	_____



1,0 ltr.

Schale „BIG WAVE“

bowl  
cuenco  
bol



	cm	↑ cm	ltr.	Farbe / Colour
83587	33 x 24	8,5	1	_____



Etagère

etagère  
expositor  
présentoir



**inklusive Edelstahl-Schild, beschriftbar**  
including stainless steel sign, inscribable  
placa de acero inoxidable incluida, rotulable  
étiquette en acier inox incluse, inscriptible

	Ø cm	↑ cm	
34248	31 - 41 - 51	55	3-stufig / 3-tier 3 niveles / 3 étages

# FLYING BUFFET



## Fingerfood-Teller „FLYING BUFFET“

fingerfood plate  
plato para el aperitivo  
assiette pour apéritif



	cm	↑ cm	Farbe / Colour
83878	9,5 x 9,5	1,5 / 3,5	White
83879	9,5 x 9,5	1,5 / 3,5	Black



## Schale „FLOAT“

bowl  
cuenco  
bol



	cm	↑ cm	Farbe / Colour
83912	9 x 9	4,5	White
83913	9 x 9	4,5	Black



## GN Tablett

GN tray  
GN bandeja  
GN plateau



	cm	↑ cm	GN
83828	53 x 32,5	2,5	1/1



## GN Edelstahl Tablett

GN stainless steel platter  
GN bandeja de acero inoxidable  
GN plateau en acier inox



	cm	GN
11119	53 x 32,5	1/1

# CASCADE



83960

## Schale „CASCADE“

bowl  
cuenco  
bol



	cm	↑ cm	GN	ltr.
83960	32,5 x 26,5	7,5	1/2	3,65
83962	26,5 x 16,2	7,5	1/4	1,50



83965

83967

## Tablett „CASCADE“

tray  
bandeja  
plateau



	cm	↑ cm	GN	fits to
83965	32,5 x 26,5	2,4	1/2	83960
83967	26,5 x 16,2	2,4	1/4	83962



Tablett kann als Deckel eingesetzt werden!

Tray is also useable as a cover!

¡La bandeja se puede usar como tapa!

Le plat s'utilise aussi comme couvercle!



83961

83966

## Schale „CASCADE“

bowl  
cuenco  
bol



	cm	↑ cm	GN	ltr.
83961	53 x 16,2	7,5	2/4	3,65

## Tablett „CASCADE“

tray  
bandeja  
plateau

	cm	↑ cm	GN	fits to
83966	53 x 16,2	2,4	2/4	83961





# FLOAT



- Ideal für den Thekenbereich
- stapelbar mit Löffel und Deckel
- Schalenboden fixiert sich auf dem Deckel
- rutschfest (Antirutschfüßchen)
  
- ideal for the counter area
- stackable with spoon and lid
- the bottom of the bowl is fixed on the lid
- non-slip (with non-slip feet)
  
- ideal para la zona del mostrador
- apilable con cuchara y tapa
- el fondo del cuenco se fija en la tapa
- antideslizante (con pies antideslizantes)
  
- idéal pour l'aire de comptoir
- empilable avec cuillère et couvercle
- le fond du bol se fixe sur le couvercle
- antidérapant (avec pieds antidérapants)



## Schale „FLOAT“

bowl  
cuenco  
bol



	Ø cm	↑ cm	ltr.	Farbe / Colour
83900	5,5	3,0	0,03	White
83902	9,0	4,5	0,15	White
83904	13,0	6,5	0,45	White
83906	15,0	7,5	0,70	White
83908	20,5	10,0	1,90	White
83901	5,5	3,0	0,03	Black
83903	9,0	4,5	0,15	Black
83905	13,0	6,5	0,45	Black
83907	15,0	7,5	0,70	Black
83909	20,5	10,0	1,90	Black



Schale „FLOAT“

bowl  
cuenco  
bol



	cm	↑ cm	ltr.	Farbe / Colour
83910	5,5 x 5,5	3,0	0,03	White
83912	9,0 x 9,0	4,5	0,16	White
83914	12,5 x 12,5	6,0	0,50	White
83916	19,0 x 19,0	9,5	1,90	White
83918	25,0 x 25,0	12,0	4,70	White
83911	5,5 x 5,5	3,0	0,03	Black
83913	9,0 x 9,0	4,5	0,16	Black
83915	12,5 x 12,5	6,0	0,50	Black
83917	19,0 x 19,0	9,5	1,90	Black
83919	25,0 x 25,0	12,0	4,70	Black



stapelbar  
stackable



GN Tablett „FLOAT“

GN tray  
GN bandeja  
GN plateau



	cm	↑ cm	GN	Farbe / Colour
83923	53,0 x 32,5	3	1/1	White
83925	32,5 x 26,5	3	1/2	White
83924	53,0 x 32,5	3	1/1	Black
83926	32,5 x 26,5	3	1/2	Black



Deckel „FLOAT“ mit Löffelaussparung

cover, with notched for spoons  
tapa, con espacio para la cuchara  
couverture, avec encoche pour la louche



	cm	↑ cm	fits to
83920	Ø 20,5	1,3	83908, 83909
83921	19 x 19	1,3	83916, 83917
83922	25 x 25	1,3	83918, 83919

# PURE



83401

83479

84441

## Tablett „PURE“ tray bandeja plateau



	cm	↑ cm	GN	Farbe / Colour
83401	53,0 x 32,5	3	1/1	White
83588	35,4 x 32,5	3	2/3	White
83433	53,0 x 16,2	3	2/4	White
83480	32,5 x 26,5	3	1/2	White
83481	32,5 x 17,6	3	1/3	White
83482	26,5 x 16,2	3	1/4	White
83882	65,0 x 26,5	3		White
83597	40,0 x 30,0	3	Bäcker-Maß	White

	cm	↑ cm	GN	Farbe / Colour
83479	53,0 x 32,5	3	1/1	Black
83589	35,4 x 32,5	3	2/3	Black
83434	53,0 x 16,2	3	2/4	Black
83490	32,5 x 26,5	3	1/2	Black
83491	32,5 x 17,6	3	1/3	Black
83492	26,5 x 16,2	3	1/4	Black
83592	40,0 x 30,0	3	Bäcker-Maß	Black

	cm	↑ cm	GN	Farbe / Colour
84440	53,0 x 32,5	3	1/1	Granite
84441	32,5 x 26,5	3	1/2	Granite

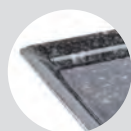

Granitoptik  
granite look





Tablett „PURE“

tray  
bandeja  
plateau



	cm	↑ cm	Farbe / Colour
83625	31,0 x 10,5	2	
83403	35,5 x 18,0	3	
83417	30,0 x 21,0	3	
83402	53,0 x 18,0	3	

	cm	↑ cm	Farbe / Colour
83483	53 x 18	3	

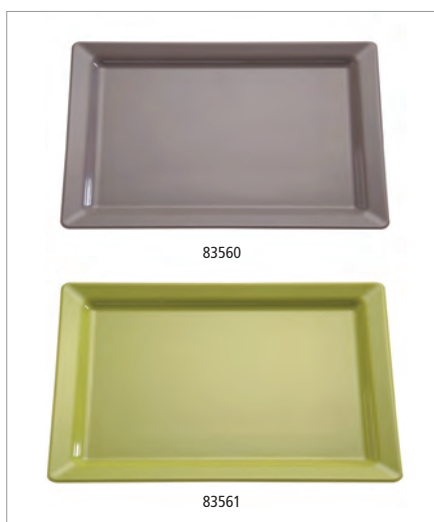

Tablett „PURE COLOR“

tray  
bandeja  
plateau

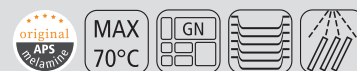

	cm	↑ cm	GN	Farbe / Colour
83560	53,0 x 32,5	3	1/1	
83562	32,5 x 26,5	3	1/2	
83561	53,0 x 32,5	3	1/1	
83563	32,5 x 26,5	3	1/2	



Tablett quadratisch „PURE“

tray square  
bandeja cuadrada  
plateau carré



	cm	↑ cm	Farbe / Colour
83418	18,0 x 18,0	3	
83407	21,0 x 21,0	3	
83406	26,5 x 26,5	3	
83405	37,0 x 37,0	3	
83404	51,0 x 51,0	3	

	cm	↑ cm	Farbe / Colour
83400	51 x 51	3	



Tablett / Teller „PURE“

tray / plate  
bandeja / plato  
plateau / assiette



	Ø cm	↑ cm	Farbe / Colour
83884	31	2,5	
83869	38	2,5	
83886	41	2,5	
83484	51	2,5	



Schale „PURE“

bowl  
cuenco  
bol



	Ø cm	↑ cm	ltr.	Farbe / Colour
83450	5,5	4,0	0,02	White
83419	9,0	4,5	0,09	White
83453	13,0	6,5	0,30	White
83455	15,0	7,5	0,45	White
83415	20,0	10,5	1,25	White
	Ø cm	↑ cm	ltr.	Farbe / Colour
83451	5,5	4,0	0,02	Black
83452	9,0	4,5	0,09	Black
83454	13,0	6,5	0,30	Black
83456	15,0	7,5	0,45	Black
83457	20,0	10,5	1,25	Black



Teller, rund „CASUAL“

plate, round  
plato, redondo  
assiette, ronde



	Ø cm	↑ cm
83500	22,5	2,5
83514	26,5	2,5



0,05 ltr. - 8,0 ltr.

Schale „PURE COLOR“

bowl  
cuenco  
bol



	cm	↑ cm	ltr.	Farbe / Colour
84424	6,5 x 6,5	3,0	0,05	White
83414	9,0 x 9,0	4,0	0,14	White
83410	12,5 x 12,5	6,5	0,40	White
83409	19,0 x 19,0	9,0	1,50	White
83408	25,0 x 25,0	12,0	3,80	White
84425	32,0 x 32,0	14,0	8,0	White
	cm	↑ cm	ltr.	Farbe / Colour
84426	6,5 x 6,5	3,0	0,05	Black
83466	9,0 x 9,0	4,0	0,14	Black
83467	12,5 x 12,5	6,5	0,40	Black
83468	19,0 x 19,0	9,0	1,50	Black
83469	25,0 x 25,0	12,0	3,80	Black
84427	32,0 x 32,0	14,0	8,0	Black
	cm	↑ cm	ltr.	Farbe / Colour
83568	9,0 x 9,0	4,0	0,14	Brown
83570	12,5 x 12,5	6,5	0,40	Brown
83572	19,0 x 19,0	9,0	1,50	Brown
83574	25,0 x 25,0	12,0	3,80	Brown
	cm	↑ cm	ltr.	Farbe / Colour
83569	9,0 x 9,0	4,0	0,14	Olive Green
83571	12,5 x 12,5	6,5	0,40	Olive Green
83573	19,0 x 19,0	9,0	1,50	Olive Green
83575	25,0 x 25,0	12,0	3,80	Olive Green



Schale „PURE BICOLOR“

bowl  
cuenco  
bol



	cm	↑ cm	ltr.	Farbe / Colour
84414	9,0 x 9,0	4,0	0,14	■ ■
84409	19,0 x 19,0	9,0	1,50	■ ■
84408	25,0 x 25,0	12,0	3,80	■ ■

	cm	↑ cm	ltr.	Farbe / Colour
84420	9,0 x 9,0	4,0	0,14	■ ■
84421	12,5 x 12,5	6,5	0,40	■ ■
84422	19,0 x 19,0	9,0	1,50	■ ■
84423	25,0 x 25,0	12,0	3,80	■ ■

	cm	↑ cm	ltr.	Farbe / Colour
84415	9,0 x 9,0	4,0	0,14	■ ■
84416	12,5 x 12,5	6,5	0,40	■ ■
84417	19,0 x 19,0	9,0	1,50	■ ■
84418	25,0 x 25,0	12,0	3,80	■ ■



Schale „SLATE“

bowl  
cuenco  
bol



	cm	↑ cm	ltr.
84244	19 x 19	9	1,5
84245	25 x 25	12	3,8

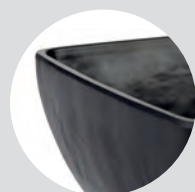

1:1 Oberflächenansicht  
1:1 structural view



Deckel „PURE“ mit Löffelaussparung

cover with notched for spoons  
tapa con espacio para la cuchara  
couverture avec encoche pour la louche



	cm	↑ cm	fits to
83600	19 x 19	1,5	84409, 84417, 84422, 83409, 83468, 83572, 83573
83601	25 x 25	1,5	84408, 84418, 84423, 84430, 83575, 83574, 83469, 83408
83602	32 x 32	1,5	84425, 84427





83603

passend zu Schalen 12,5 x 12,5 cm  
fits to bowls 12,5 x 12,5 cm



83604

passend zu Schalen 19 x 19 cm  
fits to bowls 19 x 19 cm



83410



83468

### Deckel „PURE“, 5er Set

cover, 5 pcs.  
tapa, set de 5  
couvercle, set de 5

PP POLYPROPYLENE  
BPA FREE  
original APS melamine  
MAX 70°C  
EDELSTAHL STAINLESS INOX  
Made in Germany

Hygienischer Schutz für Ihre Speisen

- dichtschießend
- schwappsicherer Transport
- BPA-frei

protection for your food

- tightly closing
- slosh-proof transport
- bpa-free

protección de alimentos

- con cierre hermético
- transporte sin salpicaduras
- libre de BPA

protection des aliments

- fermeture hermétique
- transport sans éclaboussures
- sans BPA

	cm	↑ cm	VE	fits to
83603	13,0 x 13,0	0,5	5	83410, 83467, 83570, 83571, 84410, 84416, 84421
83604	19,5 x 19,5	0,5	5	83409, 83468, 83572, 83573, 84244, 84409, 84417, 84422, 84830



83497



83498

### Schale „PURE“

bowl  
cuenco  
bol

original APS melamine  
MAX 70°C  
EDELSTAHL STAINLESS INOX

	cm	↑ cm	litr.
83497	22,5 x 15,5	7,5	0,80
83498	38,5 x 15,5	7,5	1,50
83499	51,0 x 15,5	7,5	2,40



### Menage „PURE“

menage  
conjunto aperitivo  
set apéritif

original APS melamine  
MAX 70°C  
EDELSTAHL STAINLESS INOX

4-teilig: 1 Ständer, Edelstahl matt poliert + 3 Melamin-Schalen, weiß (Nr. 83419)

4 pcs. set: 1 stainless stand satin polished finish + 3 white bowls (No. 83419)

set de 4: 1 soporte, acero inoxidable pulido mate + 3 cuencos de melamina blancos (ref. 83419)

set de 4: 1 support, acier inox poli mat + 3 bols de mélamine blancs (ref. 83419)

	cm	↑ cm
09924	14 x 14	16



### Menage „PURE“

menage  
conjunto aperitivo  
set apéritif

original APS melamine  
MAX 70°C  
EDELSTAHL STAINLESS INOX

5-teilig: 1 Ständer, Edelstahl matt poliert + 4 Melamin-Schalen, weiß (Nr. 83414)

5 pcs. set: 1 stainless stand satin polished finish + 4 square white bowls (No. 83414)

set de 5: 1 soporte, acero inoxidable pulido mate + 4 cuencos de melamina blancos (ref. 83414)

set de 5: 1 support, acier inox poli mat + 4 bols de mélamine blancs (ref. 83414)

	cm	↑ cm
09923	17 x 17	16



**Schale / Pastateller „PURE“**

bowl / pasta plate  
cuenco / plato para pasta  
bol / assiette creuse



	∅ cm	↑ cm	ltr.	Farbe / Colour
83412	32,0	7,5	1,5	White
83411	45,5	9,0	1,7	White



**Tablett „MADE FOR PURE“**

tray  
bandeja  
plateau



Edelstahl matt poliert, passend für Melamin-Schalen  
stainless steel satin polished finish, for melamin bowls  
acero inoxidable pulido mate, apta para cuencos de melamina  
acier inox poli mat, pour bols de mélamine

	cm	
30120	20 x 11	für 2 Schalen / for 2 bowls para 2 cuencos / pour 2 bols
30121	29 x 20	für 6 Schalen / for 6 bowls para 6 cuencos / pour 6 bols

**Schale „PURE COLOR“ / bowl / cuenco / bol**

	cm	↑ cm	ltr.	Farbe / Colour
83414	9 x 9	4	0,14	White
83466	9 x 9	4	0,14	Black
83568	9 x 9	4	0,14	Grey
83569	9 x 9	4	0,14	Green

**Schale „PURE BICOLOR“ / bowl / cuenco / bol**

	cm	↑ cm	ltr.	Farbe / Colour
84414	9 x 9	4	0,14	Black/White
84415	9 x 9	4	0,14	Green/White
84420	9 x 9	4	0,14	Grey/White



**GN Tablett**

GN tray  
GN bandeja  
GN plateau



	cm	↑ cm	GN
84046	53,0 x 32,5	2	1/1
84047	32,5 x 26,5	2	1/2
84048	32,5 x 17,6	2	1/3

## NATURAL COLLECTION



### Blattschale „NATURAL COLLECTION“ leaf fuente en forma de hoja plateau feuille



MAX  
70°C



	cm	↑ cm	Farbe / Colour
84083	40 x 18,5	3,5	White
84086	52 x 25,0	4,0	White
	cm	↑ cm	Farbe / Colour
84085	40 x 18,5	3,5	Green
84088	52 x 25,0	4,0	Green



### Palmblattschale „NATURAL COLLECTION“ palm leaf fuente en forma de hoja de palmera plateau feuille de palme



MAX  
70°C



	cm	↑ cm	ltr.	Farbe / Colour
84080	40 x 18,5	10	1,8	White
84082	40 x 18,5	10	1,8	Green



stapelbar, mit Löffelablage  
stackable, for spoons  
apilable, práctico para cubiertos de servicio  
empilable, pratique pour déposer les couverts



### Blattschale „NATURAL COLLECTION“ leaf fuente en forma de hoja plateau feuille



MAX  
70°C



	cm	↑ cm	Farbe / Colour
83864	34,5 x 8	2,5	White
83862	34,5 x 8	2,5	Green



### Blattschale „NATURAL COLLECTION“ leaf fuente en forma de hoja plateau feuille



MAX  
70°C

NON  
SLIP FEET



	cm	↑ cm	Farbe / Colour
83435	36 x 16	3,0	White
83438	45 x 24	3,0	White
83441	53 x 29	3,5	White
	cm	↑ cm	Farbe / Colour
83437	36 x 16	3,0	Green
83440	45 x 24	3,0	Green
83443	53 x 29	3,5	Green



**Palmblattschale „NATURAL COLLECTION“**

palm leaf  
fuente en forma de hoja de palmera  
plateau feuille de palme



	cm	↑ cm	Farbe / Colour
83865	27 x 27	4,5	
83446	35 x 34	4,5	



**Schale „FLOWER POT“**

bowl  
cuenco  
bol



	Ø cm	↑ cm	ltr.	Farbe / Colour
84470	6	3,5	0,04	
84471	6	3,5	0,04	
84472	6	3,5	0,04	

	Ø cm	↑ cm	ltr.	Farbe / Colour
84473	9	8,5	0,30	
84474	9	8,5	0,30	
84475	9	8,5	0,30	

	Ø cm	↑ cm	ltr.	Farbe / Colour
84476	12	3,5	0,20	
84478	12	3,5	0,20	

	Ø cm	↑ cm	ltr.	Farbe / Colour
84479	13	15	1,00	
84481	13	15	1,00	



**Schale „POKE BOWL“**

bowl  
cuenco  
bol



	Ø cm	↑ cm	ltr.	Farbe / Colour
85003	20	7	0,9	white
85005	20	7	0,9	coconut



**Schale, oval „CLASSIC WAVE“**

bowl, oval  
cuenco, ovalada  
plateau ovale



	cm	↑ cm	ltr.	Farbe / Colour
83875	27 x 17	4,0	0,80	
83876	34 x 21	4,5	1,30	
83877	47 x 29	5,0	3,20	





# ENAMEL LOOK



Suppenteller „ENAMEL LOOK“  
soup plate  
plato hondo  
assiette creuse



	Ø cm	↑ cm	Farbe / Colour
84952	19,0	3	
84953	22,5	4	
84954	24,5	4	



Schale „ENAMEL LOOK“  
bowl  
cuenco  
bol



	Ø cm	↑ cm	ltr.	Farbe / Colour
84490	5,5	4,0	0,02	
84491	9,5	4,5	0,09	
84492	13,0	6,5	0,30	
84493	15,0	7,5	0,45	
84494	20,0	10,5	1,25	



Schale „ENAMEL LOOK“

bowl  
cuenco  
bol



	cm	↑ cm	ltr.	Farbe / Colour
84955	15,5 x 11,5	3,5	0,25	
84956	17,5 x 13,0	4,5	0,30	



Teller „ENAMEL LOOK“

plate  
plato  
assiette



	Ø cm	↑ cm	Farbe / Colour
84950	20,5	2,0	
84951	24,5	2,5	

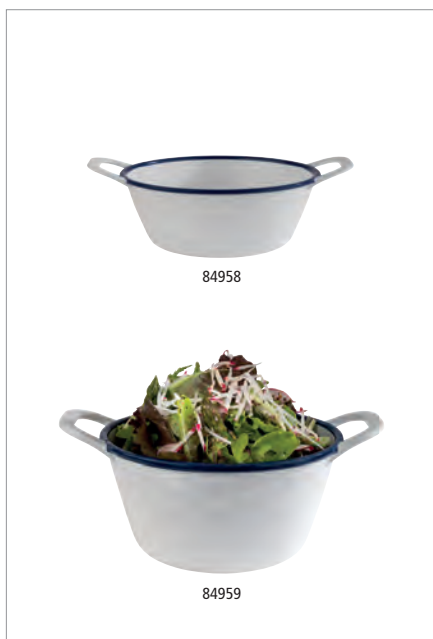

Schale „ENAMEL LOOK“

bowl  
cuenco  
bol



	cm	↑ cm	ltr.	Farbe / Colour
84958	15,0 x 11,5	6,5	0,30	
84959	21,5 x 16,5	9,5	1,00	



Schale „ENAMEL LOOK“

bowl  
cuenco  
bol



	cm	↑ cm	ltr.	Farbe / Colour
84957	29,0 x 23,5	5	1,5	

# CASUAL



## Schälchen „CASUAL MINI“

bowl  
cuenco  
bol mini



MAX  
70°C



	cm	↑ cm	ltr.	Farbe / Colour
83880	6,0	2,5	0,02	White
83881	7,5	3,5	0,05	White



## Schale „CASUAL MAXI“

bowl  
cuenco  
bol



MAX  
70°C



	Ø cm	↑ cm	ltr.	Farbe / Colour
83696	10	4,5	0,15	White
83698	12	5,5	0,25	White
83700	14	6,5	0,50	White
83704	20	9,2	1,80	White
83702	23	10,5	2,50	White
.....				
	Ø cm	↑ cm	ltr.	Farbe / Colour
83697	10	4,5	0,15	Black
83699	12	5,5	0,25	Black
83701	14	6,5	0,50	Black
83705	20	9,2	1,80	Black
83703	23	10,5	2,50	Black

Deckel „FLOAT“ mit Löffelaussparung / cover, with notched for spoons / tapa, con espacio para la cuchara / couvercle, avec encoche pour la louche

	Ø cm	↑ cm	fits to
83920	20,5	1,3	83704, 83705



## Dipschälchen „CASUAL“

dip bowl  
cuenco para dip  
ramequin



MAX  
70°C



	Ø cm	↑ cm	ltr.	Farbe / Colour	VE / unit
83780	6,0	3,7	0,04	White	24
83781	7,0	3,7	0,05	White	24
83782	7,8	4,0	0,08	White	24
83783	8,5	4,5	0,11	White	24
83784	9,8	4,5	0,14	White	12
83798	6,0	3,7	0,04	Black	24
83777	6,0	3,5	0,03	Terracotta	24



## Set „CASUAL“, 4-teilig

set, 4 pcs.  
set de 4  
set de 4



4-teiliges Set:  
• 2 Schalen + 2 Deckel  
• dichtschießend

4 pcs.:  
• 2 bowls + 2 covers  
• tightly closing

set de 4:  
• 2 cuencos + 2 tapas  
• con cierre hermético

set de 4:  
• 2 bols + 2 couvercles  
• fermeture hermétique

	Ø cm	↑ cm	ltr.	Farbe / Colour
85160	14	6,5	0,5	■
85161	14	6,5	0,5	■
85162	20	9	1,8	■
85163	20	9	1,8	■

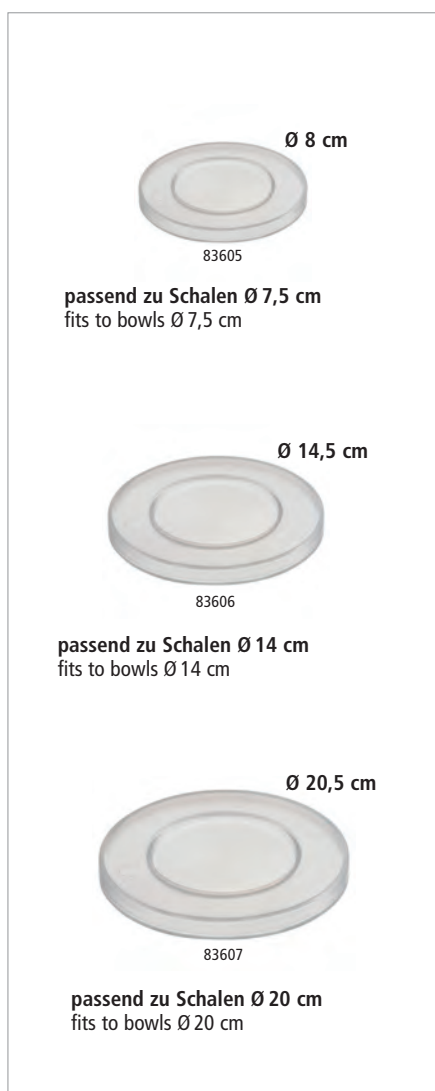

## Deckel „CASUAL“, 5er Set

cover, 5 pcs.  
tapa, set de 5  
couvercle, set de 5



Hygienischer Schutz für Ihre Speisen

• dichtschießend  
• schwappsicherer Transport  
• BPA-frei

protection for your food  
• tightly closing  
• slosh-proof transport  
• bpa-free

protección de alimentos  
• con cierre hermético  
• transporte sin salpicaduras  
• libre de BPA

protection des aliments  
• fermeture hermétique  
• transport sans éclaboussures  
• sans BPA

	Ø cm	↑ cm	VE	fits to
83605	8,0	0,5	5	11866, 83881, 15400, 15408, 15416, 15461, 15462, 15467, 15468, 40655, 40656
83606	14,5	0,5	5	11865, 83700, 83701, 84990, 85104, 85105, 85107
83607	20,5	0,5	5	83704, 83705, 15105, 15230, 15404, 15412, 15420, 85003, 85005

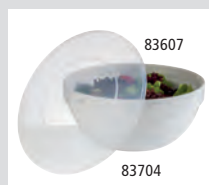

stapelbar / stackable



CASUAL · SCANTIC · ORGANIC



Schale „CASUAL“

bowl  
cuenco  
bol



MAX  
70°C



	∅ cm	↑ cm	ltr.
84215	10	6,5 / 8,5	0,2
84216	12	7,5 / 9,5	0,3



Schale „CASUAL“

bowl  
cuenco  
bol



MAX  
70°C



	∅ cm	↑ cm	ltr.	Farbe / Colour
84295	10	7	0,13	white



Dipschale „CASUAL“

dip tray  
bandeja para dips  
plateau pour dips



MAX  
70°C





	cm	↑ cm
84220	29 x 9	3



Schale „SCANTIC“  
bowl  
cuenco  
bol



MAX 70°C

	cm	↑ cm	ltr.
84221	26,5 x 10,5	6,5	1,0
84222	53,0 x 10,5	6,5	2,0



Schale „ORGANIC“

bowl  
cuenco  
bol



MAX  
70°C



	cm	↑ cm	ltr.	Farbe / Colour
84235	32,5 x 17	5,5	1,0	white
84236	50,0 x 26	6,5	3,5	white

NEW

## BRÖTCHENSCHÜTTE



85140



85141

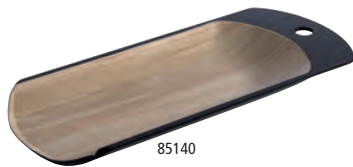

85140



85140

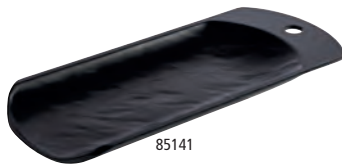

85141



85141

## Tablett „BRÖTCHENSCHÜTTE“

tray  
bandeja  
plateau

	cm	↑ cm	Farbe / Colour
85140	41 x 18	2,3	
85141	41 x 18	2,3	



85140

Griffbereich mit Aufhängeloch  
handle area with hanging hole

85141

Holzoptik  
wood lookSchieferoptik  
slate look

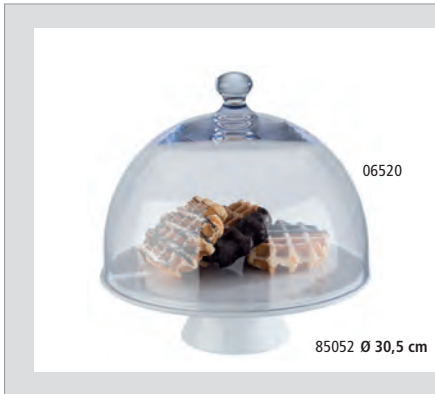

Servier- und Tortenplatte „CLASSIC“

cake stand  
porta pasteles  
présentoir à gâteaux

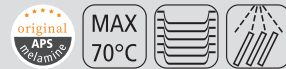

Rand fixiert die Haube  
carved edge fixes the cover  
ranura para fijar bien la campana  
bord rainuré pour maintenir ferme la cloche

	Ø cm	↑ cm
85051	30,5	9
85052	30,5	17



Servier- und Tortenplatte „CASUAL“

cake plate  
porta pasteles  
présentoir à gâteaux



	Ø cm	↑ cm
83890	31	8
83891	31	16



Servier- und Tortenplatte „CASUAL“

cake plate  
porta pasteles  
présentoir à gâteaux



	cm	↑ cm
83892	31 x 31	8
83893	31 x 31	16



Torten- / Konditorplatte

cake stand  
soporte para pastel  
présentoir à gâteaux



Rand fixiert die Haube, mit Antirutsch-Füßchen  
carved edge fixes the cover, with non-slip feet  
ranura para fijar bien la campana, con pies antideslizantes  
bord rainuré pour maintenir ferme la cloche, avec pieds antidérapants

	Ø cm	↑ cm	Farbe / Colour
00468	31,0	3,5	White
00469	31,0	3,5	Black



85042  
0,4 - 5,0 ltr.

85041

84042

### Schale „BALANCE“

bowl  
cuenco  
bol



	Ø cm	↑ cm	ltr.	Farbe / Colour
84040	14,5	9,0	0,4	White
84041	21,0	13,0	1,5	White
84042	24,5	15,0	2,5	White
84043	30,0	19,5	5,0	White

	Ø cm	↑ cm	ltr.	Farbe / Colour
85040	14,5	9,0	0,4	Black
85041	21,0	13,0	1,5	Black
85042	24,5	15,0	2,5	Black
85043	30,0	19,5	5,0	Black

### Buffetständer „KING“ / buffet stand / soporte para buffet / présentoir buffet

	Ø cm	↑ cm
03622	15	14
03623	15	21



### Tablett / Teller

tray / plate  
bandeja / plato  
plateau / assiette



	Ø cm	↑ cm	Farbe / Colour
83869	38	2,5	White

### Rolltophaube / rolltop cover / campana abatible / cloche basculante

	Ø cm	↑ cm	
18388	38	20	mit verchromtem Kugelgriff / with chrome plated handle con pomo cromado / avec bouton chromé



06510

06512

### Frischhalte-Haube

cover  
campana  
cloche



	Ø cm	↑ cm	
06510	30	11,5	
06512	30	11,5	mit verchromtem Griff / with chrom plated handle con botón cromado / avec bouton chromé



NEW

# SERVING-BOX „L“



7 tlg.  
7 pcs.



FOR  
INDOOR &  
OUTDOOR USE  
ROOM-, POOL-  
& BEACH-  
SERVICE, ...



85091



85088



85091



85091



85088

## Serving-Box „L“

serving box  
caja comida  
boîte-repas



MAX  
70°C

SILIKON  
SILICON



### 7 teiliges Set:

- 1 Box + 1 Deckel
- 1 Schale groß (23 x 14 x 6 cm, 1,4 ltr.)
- 1 Schale mittel (14 x 11,5 x 6 cm, 0,6 ltr.)
- 2 Schalen klein (11,5 x 7 x 6 cm, 0,25 ltr.)
- 1 Antirutsch-Matte (26 x 21 cm)

### 7 pcs.:

- 1 box + 1 cover
- 1 bowl large (23 x 14 x 6 cm, 1,4 ltr.)
- 1 bowl medium (14 x 11,5 x 6 cm, 0,6 ltr.)
- 2 bowls small (11,5 x 7 x 6 cm, 0,25 ltr.)
- 1 non-slip mat (26 x 21 cm)

### set de 7:

- 1 caja + 1 tapa
- 1 cuenco, grande (23 x 14 x 6 cm, 1,4 ltr.)
- 1 cuenco mediano (14 x 11,5 x 6 cm, 0,6 ltr.)
- 2 cuencos pequeños (11,5 x 7 x 6 cm, 0,25 ltr.)
- 1 esterilla antideslizante (26 x 21 cm)

### set de 7:

- 1 boîte + 1 couvercle
- 1 bol, grand (23 x 14 x 6 cm, 1,4 ltr.)
- 1 bol moyen (14 x 11,5 x 6 cm, 0,6 ltr.)
- 2 bols petits (11,5 x 7 x 6 cm, 0,25 ltr.)
- 1 tapis antidérapant (26 x 21 cm)

	cm	↑ cm	Farbe / Colour
85091	30 x 25	8	
85088	30 x 25	8	



Präsentationsmöglichkeit  
presentation example



stapelbar  
stackable



85091

Anwendungsbeispiel  
application example



Schalen  
bowls  
cuencos  
bols



	cm	↑ cm	ltr.	Farbe / Colour
85191	10,0 x 6,5	3,5	0,10	White
85193	10,0 x 10,0	3,5	0,15	White
85195	20,0 x 10,0	3,5	0,40	White
85192	10,0 x 6,5	3,5	0,10	Black
85194	10,0 x 10,0	3,5	0,15	Black
85196	20,0 x 10,0	3,5	0,40	Black

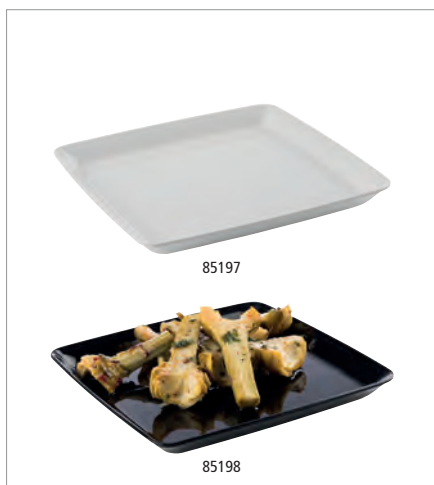

Teller  
plates  
platos  
assiettes



	cm	↑ cm	ltr.	Farbe / Colour
85197	21,5 x 21,5	2	-	White
85198	21,5 x 21,5	2	-	Black



Servierlöffel „PROFI“  
serving spoon  
cuchara para servir  
cuillère de service



	cm	→ cm	Farbe / Colour
84020	7 x 6,5	26,5	White
84021	7 x 6,5	26,5	Black



Salat-Löffel  
salad spoon  
cuchara para ensalada  
cuillère à salade



	cm	↑ cm
84035	24 x 7	4,5

## BUFFET • TABLEWARE MELAMINE



### Besteckablage „SPOON“

cutlery rest  
reposa cuchara  
pose-cuillère



	cm	↑ cm
83801	26 x 10,5	5



### Besteckablage „BOWL“

cutlery rest  
reposa cuchara  
pose-cuillère



	cm	↑ cm	ltr.
83803	22,5 x 11	6	0,5



### Besteckablage „SMALL WAVE“

cutlery rest  
reposa cuchara  
pose-cuillère



	cm	↑ cm
83897	26 x 13	4,5



### Teller mit Glashalter „COCKTAIL“

plate with glass holder  
plato sujeta copas  
assiette porte-verre



eignet sich besonders für Stehempfänge, einhändig nutzbar  
particularly suitable for standing receptions, single-handed use  
para uso en recepciones de pie, facil de usar con sólo una mano  
particulièrement pour des receptions debout, utilisable avec une seule main

	cm	↑ cm
84620	22 x 14	1,5

	Ø cm	↑ cm
84621	19	1,5



### Kaffebecher „CASUAL“

coffee cup  
taza de café  
tasse à café



	Ø cm	↑ cm	ltr.
83513	9,5	10	0,4



### Eierbecher, 4er Set

egg holder, 4 pcs. set  
huevera, set de 4  
coquetier, set de 4



	Ø cm	↑ cm	pcs.
83851	8	3	4
83848	8,5	2	4

# FINGERFOOD LÖFFEL



**Fingerfood Löffel „HALFTONE“**  
party spoon  
cuchara party  
cuillère party



	Ø cm	↑ cm	VE / unit
84158	5,5	7	24



**Fingerfood Löffel „HALFTONE“**  
party spoon  
cuchara party  
cuillère party



	cm	↑ cm	VE / unit
84128	14,5 x 4,5	4,5	12



**Fingerfood Löffel „BOAT“**  
party spoon  
cuchara party  
cuillère party



	cm	↑ cm	Farbe / Colour	VE / unit
84140	14,5 x 4,5	4,5		32
84141	14,5 x 4,5	4,5		32
84142	14,5 x 4,5	4,5		12



# FINGERFOOD LÖFFEL



## Fingerfood Löffel „HONG KONG“

party spoon  
cuchara party  
cuillère party



MAX  
70°C



	cm	↑ cm	Farbe / Colour	VE / unit
83486	13 x 4,5	4,5		60
83487	13 x 4,5	4,5		60
83424	13 x 4,5	4,5		60
83426	13 x 4,5	4,5		60



## Fingerfood-Löffel „MING HING“

party spoon  
cuchara party  
cuillère party



MAX  
70°C



	cm	↑ cm	Farbe / Colour	VE / unit
83842	11 x 4,5	4		60
83843	11 x 4,5	4		60



## Fingerfood-Löffel „LEAF“

party spoon  
cuchara party  
cuillère party



MAX  
70°C



	cm	↑ cm	Farbe / Colour	VE / unit
83889	10 x 4,5	1,5		50
83887	10 x 4,5	1,5		50
83888	10 x 4,5	1,5		50



# MINI



84625



84626



84627

## Schale „MINI COLOUR“

bowl  
cuenco  
bol



	cm	↑ cm	ltr.	Farbe / Colour	VE / unit
84625	12,5 x 9,0	3,5	0,02		12
84626	12,5 x 9,0	3,5	0,02		12
84627	12,5 x 9,0	3,5	0,02		12



84840



84841

## Schale „MINI LEAF“

bowl  
cuenco  
bol



	cm	↑ cm	ltr.	Farbe / Colour	VE / unit
84840	10,5 x 7,5	2,5	0,04		40
84841	10,5 x 7,5	2,5	0,04		40



84842



84843

## Schale „MINI LEAF“

bowl  
cuenco  
bol



	cm	↑ cm	ltr.	Farbe / Colour	VE / unit
84842	10,5 x 6,5	4,5	0,06		40
84843	10,5 x 6,5	4,5	0,06		40



84844



84845

## Schale „MINI LEAF“

bowl  
cuenco  
bol



	cm	↑ cm	ltr.	Farbe / Colour	VE / unit
84844	14,5 x 6,0	3,0	0,05		40
84845	14,5 x 6,0	3,0	0,05		40



**Schale „MINI“**  
bowl  
cuenco  
bol

original  
APS  
melamine

MAX  
70°C

Farbe / Colour

	cm	↑ cm	ltr.	Farbe / Colour	VE / unit
84750	8 x 8	3	0,06		24
84760	8 x 8	3	0,06		24



**Schale „MINI“**  
bowl  
cuenco  
bol

original  
APS  
melamine

MAX  
70°C

Farbe / Colour

	cm	↑ cm	ltr.	Farbe / Colour	VE / unit
84751	9,5 x 9,5	3	0,1		24
84761	9,5 x 9,5	3	0,1		24



**Schale „MINI“**  
bowl  
cuenco  
bol

original  
APS  
melamine

MAX  
70°C

Farbe / Colour

	cm	↑ cm	ltr.	Farbe / Colour	VE / unit
84752	9,5 x 8	3	0,08		24
84762	9,5 x 8	3	0,08		24



**Schale / Schiffchen „MINI“**  
bowl  
cuenco  
bol

original  
APS  
melamine

MAX  
70°C

Farbe / Colour

	cm	↑ cm	ltr.	Farbe / Colour	VE / unit
84753	12,5 x 5,5	4	0,06		24
84763	12,5 x 5,5	4	0,06		24



**Schale / Schiffchen „MINI“**  
bowl  
cuenco  
bol

original  
APS  
melamine

MAX  
70°C

Farbe / Colour

	cm	↑ cm	ltr.	Farbe / Colour	VE / unit
84754	14 x 6,5	4	0,1		24
84764	14 x 6,5	4	0,1		24



Teller „MINI“  
plate  
plato  
assiette



	cm	↑ cm	ltr.	VE / unit
84444	10,5 x 8,5	2,0	0,07	20



Schale „MINI“  
bowl  
cuenco  
bol



	cm	↑ cm	ltr.	VE / unit
84445	10,5 x 6,0	4,0	0,07	20
84446	13,5 x 7,5	3,0	0,07	20
84448	9,5 x 9,0	5,5	0,09	20
84449	13,0 x 12,0	7,5	0,18	20



Schale „MINI“  
bowl  
cuenco  
bol



	Ø cm	↑ cm	ltr.	Farbe / Colour
84775	8,5	2,5	0,07	White
84778	8,5	2,5	0,07	Black
84781	8,5	2,5	0,07	Dark Grey



Schale „MINI“  
bowl  
cuenco  
bol



	Ø cm	↑ cm	ltr.	Farbe / Colour
84776	8,5	2,5	0,07	White
84779	8,5	2,5	0,07	Black
84782	8,5	2,5	0,07	Dark Grey



Schale „MINI“  
bowl  
cuenco  
bol



	cm	↑ cm	ltr.	Farbe / Colour
84777	9,5 x 5,5	5,5	0,07	White
84780	9,5 x 5,5	5,5	0,07	Black
84783	9,5 x 5,5	5,5	0,07	Dark Grey





Schale „MINI“  
bowl  
cuenco  
bol



	cm	↑ cm	ltr.	VE / unit
84452	11,5 x 7,5	3,0	0,06	24
84454	11,5 x 6,0	5,5	0,04	24
84456	8,5 x 7,0	6,0	0,07	24
84458	8,0 x 8,0	4,0	0,10	24
84450	7,5 x 7,0	4,5	0,05	24

Schälchen „GOURMET“ / bowl / cuenco / bol

	Ø cm	↑ cm	ltr.
84018	7	6	0,05



Schale „HALFTONE“  
bowl  
cuenco  
bol



	Ø cm	↑ cm	ltr.	VE / unit
84217	8,0	4,0	0,1	12



Schale „MINI“  
bowl  
cuenco  
bol



	cm	↑ cm	ltr.	VE / unit
84460	35 x 4,5	3	0,20	10



Tablett „GOURMET“  
tray  
bandeja  
plateau



mit 3 Absätzen Ø 4 cm  
with 3 holes Ø 4 cm  
con 3 agujeros Ø 4 cm  
avec 3 trous Ø 4 cm

	cm	↑ cm
84017	30,5 x 9,5	2,5

Schälchen „GOURMET“ / bowl / cuenco / bol

	Ø cm	↑ cm	ltr.
84018	7	6	0,05

hot  
price

GN 2/4



GN 1/1



GN 1/2



GN 1/4



GN 1/6

## GN-Behälter „ECOLINE“

GN container

GN cubeta

GN bac



	GN	↓ mm	ltr.	cm	Farbe / Colour
83759	1/1	65	7,10	53,0 x 32,5	White
83755	2/4	65	3,00	53,0 x 16,2	White
83757	1/2	65	3,40	32,5 x 26,5	White
83753	1/3	65	2,00	32,5 x 17,6	White
83751	1/4	65	1,35	26,5 x 16,2	White
83749	1/6	65	0,80	17,6 x 16,2	White

	GN	↓ mm	ltr.	cm	Farbe / Colour
83758	1/1	65	7,10	53,0 x 32,5	Black
83754	2/4	65	3,00	53,0 x 16,2	Black
83756	1/2	65	3,40	32,5 x 26,5	Black
83752	1/3	65	2,00	32,5 x 17,6	Black
83750	1/4	65	1,35	26,5 x 16,2	Black
83748	1/6	65	0,80	17,6 x 16,2	Black

	GN	↓ mm	ltr.	cm	Farbe / Colour
84300	1/1	100	10,6	53,0 x 32,5	White
84302	2/4	100	4,3	53,0 x 16,2	White
84301	1/2	100	4,7	32,5 x 26,5	White
84303	1/3	100	2,7	32,5 x 17,6	White
84304	1/4	100	1,9	26,5 x 16,2	White
84305	1/6	100	1,0	17,6 x 16,2	White

	GN	↓ mm	ltr.	cm	Farbe / Colour
84306	1/1	100	10,6	53,0 x 32,5	Black
84308	2/4	100	4,3	53,0 x 16,2	Black
84307	1/2	100	4,7	32,5 x 26,5	Black
84309	1/3	100	2,7	32,5 x 17,6	Black
84310	1/4	100	1,9	26,5 x 16,2	Black
84311	1/6	100	1,0	17,6 x 16,2	Black

## GN-Behälter „HIGHLINE“

GN-container

GN cubeta

GN bac



83762



83763

	GN	↓ mm	ltr.	cm
83772	1/1	65	7,10	53,0 x 32,5
83770	2/3	65	4,60	35,0 x 32,5
83768	1/2	65	3,40	32,5 x 26,5
83766	2/4	65	3,00	53,0 x 16,2
83764	1/3	65	2,00	32,5 x 17,6
83762	1/4	65	1,35	26,5 x 16,2
83760	1/6	65	0,80	17,6 x 16,2

	GN	↓ mm	ltr.	cm
83773	1/1	100	11,0	53,0 x 32,5
83769	1/2	100	5,50	32,5 x 26,5
83765	1/3	100	3,15	32,5 x 17,6
83763	1/4	100	2,20	26,5 x 16,2
83761	1/6	100	1,25	17,6 x 16,2









# Tableware Table Presentation



**NEW** LEVANTE



Levante Küche passend serviert!

Viel Gemüse, wenig Fleisch und eine Vielfalt an Gewürzen charakterisieren die Küche des Nahen Ostens. Der östliche Mittelmeerraum, also Syrien, Libanon, Jordanien, Israel und Palästina wird als Levante bezeichnet. Als Levante-Küche wird die Essenstradition dieser Länder als Food-Trend gefeiert.

Levantine cuisine served appropriately!

Lots of vegetables, little meat and a variety of spices characterise the cuisine of the Middle East. The eastern Mediterranean region, i. e. Syria, Lebanon, Jordan, Israel and Palestine is referred to as the Levant. As Levantine cuisine, the food tradition of these countries is celebrated as a food trend.

Cocina levantina servida como es debido.

Mucha verdura, poca carne y una gran variedad de especias caracterizan la cocina de Oriente Medio. La región del Mediterráneo oriental, es decir, Siria, Líbano, Jordania, Israel y Palestina, se denomina Levante. La cocina levantina, la tradición alimentaria de estos países, se celebra como una tendencia alimentaria.

Cuisine levantine servie comme il se doit!

Beaucoup de légumes, peu de viande et une variété d'épices caractérisent la cuisine du Moyen-Orient. La région de la Méditerranée orientale, c'est-à-dire la Syrie, le Liban, la Jordanie, Israël et la Palestine, est appelée le Levant. La tradition alimentaire de ces pays, la cuisine levantine, est célébrée comme une tendance alimentaire.



Schale „LEVANTE“

bowl  
cuenco  
bol

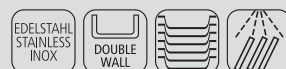

	Ø cm	↑ cm	litr.	Farbe / Colour
40700	9,5	4,5	0,14	
40701	9,5	4,5	0,14	
40702	12	6,5	0,32	
40703	12	6,5	0,32	
40704	17	8,5	0,90	
40705	17	8,5	0,90	



stapelbar  
stackable

copper red  
 grey black



Schale „LEVANTE“

bowl  
cuenco  
bol



	Ø cm	↑ cm	ltr.	Farbe / Colour
40706	7,5	2,5	0,05	
40707	7,5	2,5	0,05	
40708	8,5	5,5	0,20	
40709	8,5	5,5	0,20	
40710	8,5	8,5	0,40	
40711	8,5	8,5	0,40	



copper red  
 grey black

Präsentationsmöglichkeit  
presentation example



Tablett „LEVANTE“

tray  
bandeja  
GN plateau



	cm	↑ cm	ltr.	Farbe / Colour
40712	26,5 x 16	3	0,70	
40713	26,5 x 16	3	0,70	



copper red  
 grey black

Präsentationsmöglichkeit  
presentation example



# SUPER CUP

Der transparente Becher aus **recycelbarem** Kunststoff ist vielseitig einsetzbar:

- Buffet
- Catering
- Kantine
- Bäckerei & Coffee Shop
- Pool & Beach

Mehrweg  
statt Einweg  
**TO GO ! ...**



Eigenschaften:

- aus schlagfestem, transp. Kunststoff
- leichter als Glas
- nahezu unzerbrechlich
- für kalte und warme Speisen
- Gebrauchstemperatur bis +80°C
- langlebig und ökologisch sinnvoll



250 ml

## Becher Set „SUPER CUP“, 16-tlg.

barrel mug set, 16 pcs.  
vasos, set de 16  
gobelets, set de 16

16-teiliges Set: 8 Becher + 8 Deckel  
16 pcs. set: 8 barrel mugs + 8 lids  
set de 16: 8 vasos + 8 tapas  
set de 16: 8 gobelets + 8 couvercles



**IDEAL**  
FÜR  
„TAKE AWAY“

	Ø cm	↑ cm	ltr.
10506	8	10	0,25



mit Stapelnocke  
with stacking cam



rutschfester Deckel  
non-slip lid



0,05 ltr.

40642

0,32 ltr.

40644

## Stielkasserolle / Serviertopf

sauté pan / mini sauce pan  
cazo recto bajo  
plat à sauter



	Ø cm	↑ cm	ltr.	Griff / handle cm
40642	5,5	2,5	0,05	6
40643	7,0	3,5	0,12	8,5
40644	9,5	5,5	0,32	8,5

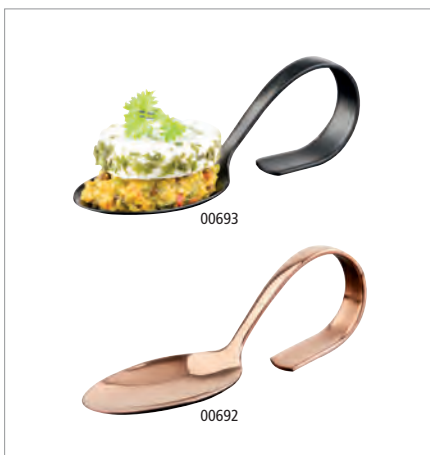

00693

00692

## Gourmet-Löffel „CLASSIC“

party spoon  
cuchara gourmet  
cuillère gourmet



	cm		
00693	12,0	gunmetal look	PVD coated stainless steel
00677	13,5	stainless steel look	
00691	12,0	Gold-Look / gold look	PVD coated stainless steel
00692	12,0	Kupfer-Look / copper look	PVD coated stainless steel



# SERVING TROWEL *super trendy*



## Servierkelle „BOB“

serving trowel  
paleta para servir  
truelle de service



Edelstahl Servierkelle mit schwarzem Holzgriff

stainless steel serving trowel with black wooden handle  
paleta para servir de acero inoxidable con mango de madera negra  
truelle de service en acier inox avec manche en bois noir

	cm	↑ cm	Griff / handle cm	
40680	23,5 x 15,5	12,5	13,5	stainless steel
40681	23,5 x 15,5	12,5	13,5	■



## Snackbox „INDUSTRIAL“

snack box  
caja tentempié  
casse-croûte



Metall, schwarz

metal, black  
metal, negro  
métal, noir

	cm	↑ cm	ltr.
40675	16,5 x 10,5	7,50	0,5
40676	23,0 x 15,5	13,0	2,4



stapelbar  
stackable



# CAST IRON



Die Servierpfännchen aus emailliertem Gusseisen dienen dem portionsweisen Servieren und halten die Speisen warm.

The serving pans made of enameled cast iron are used for serving in portions and for keeping the food warm.

Las fuentes de hierro fundido esmaltado se utilizan para servir en porciones y mantener la comida caliente.

Les plateaux de service en fonte émaillée sont utilisés pour servir en portions et garder les aliments au chaud.



## Servierpfännchen „CAST IRON“

serving pan  
fuente para servir  
plat de service



Gusseisen emailliert  
enameled cast iron  
hierro fundido esmaltado  
fonte émaillée

	∅ cm	↑ cm	Farbe / Colour
88220	10	2	
88225	10	2	
88221	13	2	
88226	13	2	



## Servierpfännchen „CAST IRON“

serving pan  
fuente para servir  
plat de service



Gusseisen emailliert  
enameled cast iron  
hierro fundido esmaltado  
fonte émaillée

	cm	↑ cm	Farbe / Colour
88222	13 x 13	2	
88227	13 x 13	2	
88223	16 x 13	2	
88228	16 x 13	2	
88224	20 x 13	2	
88229	20 x 13	2	



# SNACKHOLDER



Gold: made from PVD coated stainless steel

Die Mini-Edelstahlkörbchen dienen dem portionsweisen Servieren. Zum originellen Servieren von Beilagen geeignet, aber auch zum Frittieren selbst.

The mini frying baskets are used to present individual portions in an original way, but can still be used to fry.

Las cestas de freir ofrecen una presentación original para el servicio de tapas o raciones individuales de patatas, aperitivos, fritos, etc.

Les paniers à friture offrent une présentation originale pour servir apéritifs, snacks, tapas et autres rations individuelles. Également aptes pour frire.



## Servier-Frittierkorb „SNACKHOLDER“

stainless steel fry baskets  
cestitas inox para el servicio mesa  
paniers inox pour le service sur table



	Ø cm	↑ cm	Griff / handle cm	Farbe / Colour	
40600	8	7,5	9,5		stainless steel
40602	8	7,5	9,5		gold
40601	9	8,5	9,0		stainless steel
40603	9	8,5	9,0		gold



## Servier-Frittierkorb „SNACKHOLDER“

stainless steel fry baskets  
cestitas inox para el servicio mesa  
paniers inox pour le service sur table



	cm	↑ cm	Griff / handle cm	Farbe / Colour	
40610	21,5 x 10,5	4,5	9,5		stainless steel
40612	21,5 x 10,5	4,5	9,5		gold
40611	26,0 x 13,0	5,0	9,0		stainless steel
40613	26,0 x 13,0	5,0	9,0		gold



## Servier-Frittierkorb „SNACKHOLDER“

stainless steel fry baskets  
cestitas inox para el servicio mesa  
paniers inox pour le service sur table



	cm	↑ cm	Griff / handle cm	Farbe / Colour	
40620	10,0 x 8,5	6,5	9,0		stainless steel
40622	10,0 x 8,5	6,5	9,0		gold
40621	13,0 x 10,5	9,0	13,5		stainless steel
40623	13,0 x 10,5	9,0	13,5		gold



## SNACKHOLDER



**Snackholder**  
serving cup  
vaso para servir  
gobelet à apéritif



	Ø cm	↑ cm	ltr.	Farbe / Colour	
40616	9,5	8,5 / 11,5	0,45		Edelstahl Kupfer / stainless copper
40617	8,5	8,5	0,35		Edelstahl Kupfer / stainless copper
40618	8,5	8,5	0,35		gehämmerte Oberfläche / hammered
40605	9,5	8,5 / 11,5	0,45		Edelstahl / stainless steel
40606	8,5	8,5	0,35		Edelstahl / stainless steel
40607	8,5	8,5	0,35		gehämmerte Oberfläche / hammered



**Servier- / Saucen-Eimer „SNACKHOLDER“**  
mini stainless steel bucket  
cubo inox en formato mini  
seau mini inox



	Ø cm	↑ cm	ltr.	pcs
40630	7	6,5	0,15	4
40631	9	8,5	0,33	1



**Mini-Milchkanne „SNACKHOLDER“ 4er Set**  
mini milk can, 4 pcs.  
lechera en formato mini, set de 4  
pot à lait mini, set de 4



	Ø cm	↑ cm	ltr.	pcs.
40640	4,5	5	0,08	4



**Mini-Servierpfanne „SNACKHOLDER“**  
mini pan  
sartén en formato mini  
poêle à frire mini



	cm	↑ cm	ltr.
40660	14,5 x 9,5	4,5 / 6,5	0,5



**Snackcan**

serving can

lata para aperitivos

boîte de conserves pour apéritifs



	Ø cm	↑ cm	ltr.	
40654	6,5	4,0	0,12	ideale Beilagen Größe
40655	7,5	5,5	0,17	
40656	7,5	10,0	0,35	
40659	12,0	8,0	0,80	
40658	13,5	14,0	1,80	
40657	13,5	10,5	1,30	



**Schale**

bowl

cuenco

bol



	Ø cm	↑ cm	ltr.
40685	6	3,0	0,05
40686	8	4,5	0,17

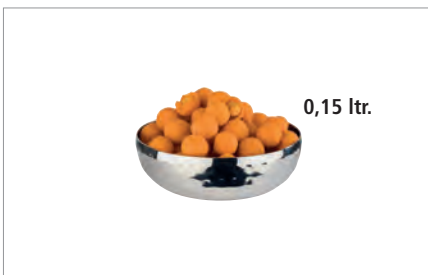

**Schale**

bowl

cuenco

bol



gehämmerte Oberfläche / hammered surface / superficie martillada / surface martelée

	Ø cm	↑ cm	ltr.
40185	9,5	3	0,15



**Serviertöpfchen**

small serving pot

olla pequeña de servir

marmite petite de servir



gehämmerte Oberfläche

hammered surface

superficie martillada

surface martelée

	Ø cm	↑ cm	ltr.	Griff / handle cm
40186	9,5	5,5	0,30	2,5
40187	13,5	5,0	0,55	3,0
40188	15,5	5,0	0,75	3,0



## SNACKHOLDER

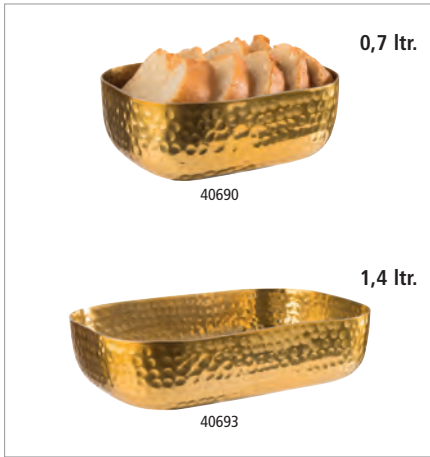

### Schale

bowl  
cuenco  
bol



gehämmerte Oberfläche  
hammered surface  
superficie martillada  
surface martelée

	cm	↑ cm	ltr.	Farbe / Colour
40690	15,5 x 12,0	5,5	0,7	gold look
40693	23,0 x 15,5	6,0	1,4	gold look

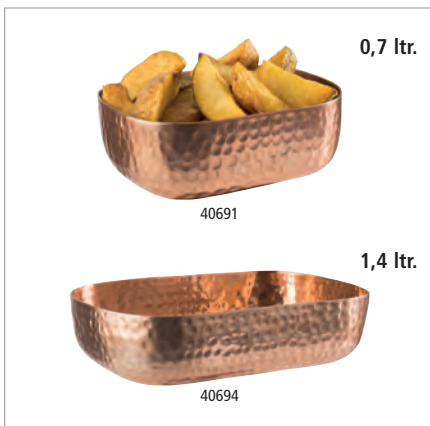

### Schale

bowl  
cuenco  
bol



gehämmerte Oberfläche  
hammered surface  
superficie martillada  
surface martelée

	cm	↑ cm	ltr.	Farbe / Colour
40691	15,5 x 12,0	5,5	0,7	copper look
40694	23,0 x 15,5	6,0	1,4	copper look



### Schale

bowl  
cuenco  
bol



gehämmerte Oberfläche  
hammered surface  
superficie martillada  
surface martelée

	cm	↑ cm	ltr.	Farbe / Colour
40692	15,5 x 12,0	5,5	0,7	gunmetal-look
40695	23,0 x 15,5	6,0	1,4	gunmetal-look



### Servierkorb „BURGER & FRIES“

serving basket  
cesta para servir  
corbeille de service



Servierkorb aus Metall mit 2 Haltern für Dipschälchen

metal serving basket with 2 holders for dip bowls

cesta de metal para servir con 2 soportes para cuencos para dip

corbeille de service en métal avec 2 supports pour ramequins

	cm	↑ cm
40604	39,5 x 20	11

passende Schälchen / fitting bowls / cuencos adecuados / bols apropiés



	ø cm	↑ cm	ltr.	VE / unit
83781	7	3,7	0,05	24

**NEW**



01010 **0,15 ltr.**



01011 **0,25 ltr.**



01012 **0,50 ltr.**

**Schale „OLIVE“**

bowl  
cuenco  
bol



aus geöltem Olivenholz  
oiled olive wood  
de madera de olivo aceitada  
en bois d'olivier huilé

	Ø cm	↑ cm	ltr.
01010	10,0	4,0	0,15
01011	12,5	4,5	0,25
01012	15,0	6,0	0,50



**3 Größen ineinander**  
3 sizes in each other

**NEW**



01013 **0,05 ltr.**



01014 **0,15 ltr.**



01015 **0,60 ltr.**

**Schale „OLIVE“**

bowl  
cuenco  
bol



aus geöltem Olivenholz  
oiled olive wood  
de madera de olivo aceitada  
en bois d'olivier huilé

	cm	↑ cm	ltr.
01013	7,5 x 7,5	2,5	0,05
01014	17,5 x 8,5	2,5	0,15
01015	26,5 x 11,5	5,0	0,60

**NEW**



01023 **0,4 ltr.**

**Schale „OLIVE“**

bowl  
cuenco  
bol



aus geöltem Olivenholz  
oiled olive wood  
de madera de olivo aceitada  
en bois d'olivier huilé

	cm	↑ cm	ltr.
01023	25 x 8,5	7,5	0,40



00843 **0,05 ltr.**



00844 **0,10 ltr.**

**Schale „OLIVE“**

bowl  
cuenco  
bol



aus geöltem Olivenholz  
oiled olive wood  
de madera de olivo aceitada  
en bois d'olivier huilé

	cm	↑ cm	ltr.
00843	12,0 x 7,5	2,5	0,05
00844	16,5 x 9,5	2,5	0,10

## SNACKHOLDER · SERVING BOARD



### Schale „OLIVE“

bowl  
cuenco  
bol



aus geöltem Olivenholz  
oiled olive wood  
de madera de olivo aceitada  
en bois d'olivier huilé

	cm	↑ cm	ltr.
00907	13 x 8	6,5	0,20
00908	16 x 9	7,0	0,30



### Servierbrett „OLIVE“

serving board  
tabla de servir  
planche de service



aus geöltem Olivenholz  
oiled olive wood  
de madera de olivo aceitada  
en bois d'olivier huilé

	cm	↑ cm
01022	39,5 x 21	2,5
01021	35,5 x 18,5	2,0



### Servierbrett „OLIVE“

serving board  
tabla de servir  
planche de service



aus geöltem Olivenholz  
oiled olive wood  
de madera de olivo aceitada  
en bois d'olivier huilé

	cm	↑ cm
00905	25,5 x 16,5	1,5
00906	35,0 x 20,5	1,5



### Servierbrett „OAK“

serving board  
tabla de servir  
planche de service



aus geöltem Eichenholz, Safrille, ø 9,5 cm Aussparung  
made of oiled oak, with juice groove, with hole ø 9.5 cm  
de madera de roble aceitada, con ranura para líquidos, con agujero ø 9,5 cm  
en bois chêne huilé, avec rigole, avec trou ø 9,5 cm

	cm	↑ cm
00808	37 x 25	2



mit Safrille / with juice groove



### Naturschieferplatte

natural slate tray  
bandeja pizarra natural  
plat ardoise naturelle



mit Absatz Ø 6 cm  
with hole Ø 6 cm  
con agujero Ø 6 cm  
avec trou Ø 6,0 cm

cm \* mm  
00986 25 x 12 6 - 9



### Naturschieferplatte

natural slate tray  
bandeja pizarra natural  
plat ardoise naturelle



mit 3 Absätzen, Ø 6 cm  
with 3 holes, Ø 6 cm  
con 3 agujeros, Ø 6 cm  
avec 3 trous, Ø 6 cm

cm \* mm  
00987 28 x 10 6 - 9



### Naturschieferplatte „STARTER“

natural slate tray  
bandeja de pizarra natural  
plat ardoise naturelle carré



cm \* mm  
00937 20 x 10 6 - 9



### Naturschieferplatte / Untersetzer

natural slate tray  
bandeja de pizarra natural  
plateau ardoise naturelle



mit 2 Absätzen Ø 6 cm  
with 2 holes Ø 6 cm  
con 2 agujeros Ø 6 cm  
avec 2 trous Ø 6 cm

cm \* mm  
00971 15 x 8 6 - 9



### Naturschieferplatte, 2-teilig

natural slate tray, 2 pcs. set  
bandeja de pizarra natural y campana  
plateau ardoise naturelle et cloche en verre



mit Glashaube  
with glass cover  
con tapa de cristal  
avec cloche en verre

cm \* mm  
00984 10,5 8 6 - 9



## SERVING BOARD



### Naturschieferplatte

natural slate  
bandeja de pizarra natural  
plateau ardoise naturelle



	cm	* mm
00941	24,0 x 15,0	6 - 9
00942	26,5 x 20,5	6 - 9
00945	47,0 x 10,0	6 - 9
00988	30,0 x 12,0	6 - 9

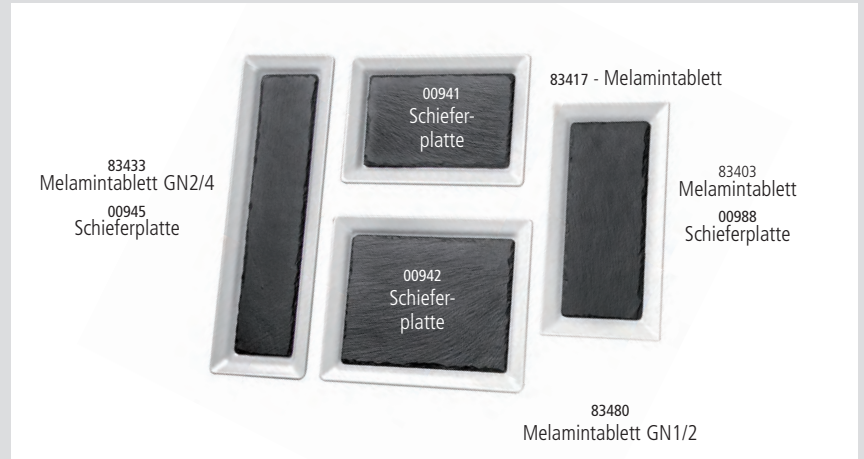

### Naturschieferplatte

natural slate tray  
bandeja de pizarra natural  
plat ardoise naturelle



	cm	* mm
00996	45 x 30	6 - 9



### Naturschieferplatte

natural slate tray  
bandeja de pizarra natural  
plat ardoise naturelle



	cm	* mm
00994	25 x 25	6 - 9
00995	30 x 30	6 - 9

**Servierbrett „SHARING“**

serving board  
tabla de servir  
planche de service



Servierbrett aus geöltem Akazienholz

serving board made of oiled acacia wood  
tabla de servir de madera de acacia aceitada  
planche en bois d'acacia huilé

	cm	↑ cm	Griff / handle cm
00887	51,5 x 18	1,5	8,5

**Servierbrett „AKAZIE-SCHIEFER“**

serving board  
tabla de servir  
planche de service

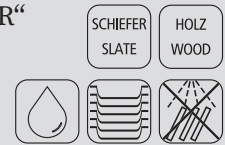

raffiniertes, rustikales Servierbrett  
aus Akazienholz, ausgestattet mit einem Naturschieferstreifen  
zur Kennzeichnung

wood with slate, markable  
madera con pizarra, se puede marcar  
bois avec ardoise, on peut mettre une inscription

	cm	↑ cm	Griff / handle cm
00867	30,5 x 13	1,5	10
00868	36,5 x 15	1,5	12
00869	42,0 x 18	1,5	14

**Servierbrett „OLIVE“**

serving board  
tabla de servir  
planche de service



Servierbrett im Naturschnitt, aus Olivenholz. Jedes Brett wird handgefertigt und geölt mit 19 mm Aufhäng Bohrung. Alle Produkte unterscheiden sich naturbedingt in Form, Maserung und Größe!

Olive Wood is known for its versatility and striking appearance with each piece having its own unique features.

El olivo es conocido por su versatilidad y aspecto espectacular y único en cada pieza. Por su fabricación a mano de forma artesanal, todas las piezas varían en tamaño, forma y acabado, lo que hace de cada una un ejemplar único.

Le bois d'olivier est reconnu pour sa versatilité et son esthétique spectaculaire. De par leur fabrication artisanale à la main, toutes les pièces varient quant à leur taille, forme et finition, de telle sorte que chacune est un exemplaire unique.

	cm	↑ cm	Griff / handle cm
00870	25,0 x 17,0	1,5	
00871	30,0 x 20,5	2,0	
00872	35,0 x 24,0	2,0	
00873	40,0 x 15,0	1,5	11
00874	44,0 x 20,0	2,0	12
00875	19,0 x 12,5	1,5	6
00876	25,0 x 16,0	1,5	8
00877	31,0 x 20,0	1,5	9

## SERVING BOARD



### Servierbrett „NARROW I“

serving board  
tabla de servir  
planche de service



**Akazienholz, mit 3 Vertiefungen Ø 4 cm**  
acacia wood, with 3 notches Ø 4 cm  
madera de acacia, con 3 ranuras Ø 4 cm  
bois d'acacia, avec 3 encoches Ø 4 cm

	cm	↑ cm
00864	22 x 8	1,5

passende Schälchen / fitting bowls / cuencos adecuados / bols appropriés

	Ø cm	↑ cm	ltr.	
82312	6	5,5	0,08	glass / 12 pcs
40685	6	3,0	0,05	stainless steel



### Servierbrett „NARROW“

serving board  
tabla de servir  
planche de service



**Akazienholz, mit 3 Vertiefungen Ø 6 cm**  
acacia wood, with 3 notches Ø 6 cm  
madera de acacia, con 3 ranuras Ø 6 cm  
bois d'acacia, avec 3 encoches Ø 6 cm

	cm	↑ cm
00878	31 x 11	2

passende Schälchen / fitting bowls / cuencos adecuados / bols appropriés

	Ø cm	↑ cm	ltr.	
40686	8	4,5	0,17	stainless steel
82316	7	8	0,22	glass / 12 pcs



### Tablett

tray  
bandeja  
plateau



**aus Bambus, geeignet zum Servieren und Transportieren**  
made of bamboo, suitable for serving and transport  
de bambú, para servir y transportar  
en bambou, pour servir et transporter

	cm	↑ cm	GN
00845	32,5 x 26,5	3	1/2
00846	32,5 x 17,6	3	1/3
00847	53,0 x 16,2	3	2/4



Präsentationsmöglichkeit  
presentation example



mit Absatz Ø 5 cm  
with hole Ø 5 cm

### Servierbrett, 2-teilig

serving board, 2 pcs. set  
tabla de servir, set de 2  
planche de service, set de 2

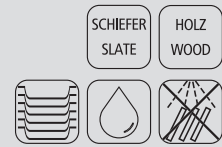

2-teilig:

1 Holzbrett aus Akazienholz + 1 Naturschieferplatte

1 wood board made of acacia wood + 1 natural slate tray

1 tabla de madera de acacia + 1 pizarra natural

1 planche en bois d'acacia + 1 ardoise naturelle

	cm	↑ cm
00814	28 x 17,5	2



### Servierbrett

serving board  
tabla de servir  
planche de service



Servierbrett aus geöltem Akazienholz

serving board made of oiled acacia wood

tabla de servir de madera de acacia aceitada

planche en bois avec plateau en bois d'acacia huilé

	cm	↑ cm
00897	30 x 15	2
00898	30 x 18	2
00899	35 x 25	2



### Servierbrett, 2-teilig

serving board, 2 pcs. set  
tabla de servir, set de 2  
planche de service, set de 2



2-teilig:

Ein rustikales Servierbrett aus Akazienholz,  
ausgestattet mit einer Naturschieferplatte

wood board oiled acacia with a slate tray

tabla de madera de acacia con una bandeja de pizarra natural

planche en bois d'acacia avec un plateau en ardoise naturelle

	cm	↑ cm	Griff / handle cm
00810	26 x 18	2	8
00811	33 x 20	2	8
00812	40 x 15	2	5
00813	43 x 12	2	12

Präsentationsmöglichkeit  
presentation example



mit Hängeloch Ø 2 cm / with a handle-hole Ø 2 cm



# SERVING BOARD



## Tablett „VINTAGE“

tray  
bandeja  
plateau



Antik-Edelstahl-Look  
stainless steel antique look  
acero estilo antiguo  
acier style antique

	cm	↑ cm
30130	26,0 x 13,5	1,5
30131	34,0 x 18,0	1,5
30132	38,0 x 26,5	1,5
30133	25,5 x 16,0	3,0

## passende Schälchen / fitting bowls / cuencos adecuados / bols apropiés



	Ø cm	↑ cm	ltr.
40655	7,5	5,5	0,17
40656	7,5	10,0	0,35



Servierbeispiel  
serving example

## passendes Wachspapier / greaseproof paper squares / papel alimenticio para cucurucho / papier alimentaire pour cornet

	cm	pcs.	
40670	42 x 25	500	Motiv: Zeitung
40671	42 x 25	500	blank
40672	42 x 25	500	Motiv: rote Karos / red
40673	42 x 25	500	Motiv: blaue Karos / blue
40674	30 x 20	500	Motiv: Fast Food / black

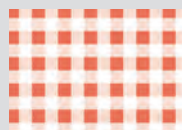

40672



40673



40674

## Tablett „TREND“

baking sheet  
bandeja  
plateau



ein Backblech wird zum Serviertablett  
a baking sheet which becomes a serving tray  
una bandeja de hornear que se convierte en una bandeja de servir  
un moule qui devient un plateau de service

	cm	↑ cm
13380	32 x 21,5	2

NEW



01016

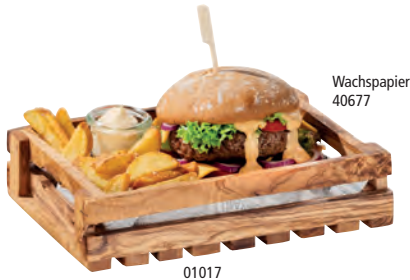

01017

**SNACKBOX „OLIVE“**snackbox  
snackbox  
snackboxaus geöltem Olivenholz  
oiled olive wood  
de madera de olivo aceitada  
en bois d'olivier huiléHOLZ  
WOOD

	cm	↑ cm
01016	22 x 15	6
01017	25 x 18	6



01016



01016

**Snackbox „INDUSTRIAL“**snack box  
caja tentempié  
casse-croûteMetall, schwarz  
metal, black  
metal, negro  
métal, noir

40675

	cm	↑ cm	litr.
40675	16,5 x 10,5	7,5	0,5
40676	23,0 x 15,5	13,0	2,4

**Holzbox „TABLE“**woodbox  
caja madera  
base boisAkazienholz, 3 Fächer (6,5 x 6,5 cm)  
acacia wood, 3 compartments (6,5 x 6,5 cm)  
madera de acacia, 3 compartimentos (6,5 x 6,5 cm)  
bois d'acacia, 3 compartiments (6,5 x 6,5 cm)Servierbeispiel - Lieferung ohne Gläser  
delivery without glasses

	cm	↑ cm	inner size cm
11727	23,5 x 8,5	4,5	6,5 x 6,5 je Fach / each compartment

**Holzbox „TABLE“**woodbox  
caja madera  
base boisAkazienholz, natur  
acacia wood, nature  
madera de acacia, natural  
bois d'acacia, naturel

40556

40555

	cm	↑ cm	inner size cm
11726	15 x 9,5	5	12 x 6,5

# GRAESERPROOF PAPER SQUARE



## Snackbox „DUO“

snackbox  
snackbox  
snackbox



Behälter aus Metall mit Tragegriff aus Holz  
container made of metal with wooden handle  
contenedor de metal con asa de madera  
conteneur métallique avec poignée en bois

	cm	↑ cm
00014	24,5 x 12	18,5



## Wachspapier „SNACKHOLDER“

greaseproof paper squares  
papel alimenticio para cucurucho  
papier alimentaire pour cornet

PAPIER  
PAPER

	cm	pcs.	
40670	42 x 25	500	Motiv: Zeitung
40671	42 x 25	500	blanco
40672	42 x 25	500	Motiv: rote Karos / red
40673	42 x 25	500	Motiv: blaue Karos / blue
40674	30 x 20	500	Motiv: Fast Food / black
40677	25 x 20	1000	Motiv: Zeitung
40678	31 x 31	1000	Motiv: Zeitung
40679	34 x 28	1000	Motiv: Zeitung

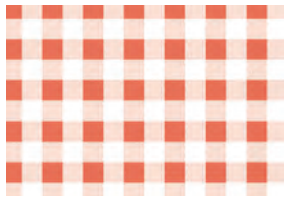

40672

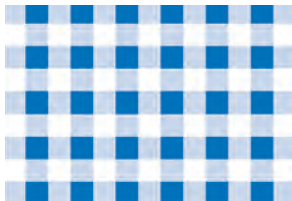

40673



40674



40678



40674



40677



40678



40679



30132

40656

40655



13380



**Pfeffermühle „COPPER“**

pepper mill  
molinillo de pimienta  
moulin à poivre



**Mahlwerk aus Carbonstahl, Mahlgrad stufenlos einstellbar**

mill in carbon steel, the grinding degree can be adjusted infinitely  
molinillo de acero al carbono, el grado de molino se puede ajustar de modo continuo  
moulin en acier de carbone, la finesse de mouture se peut réglée de façon continue

	Ø cm	↑ cm
40551	6	15

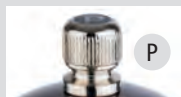

**Salzmühle „COPPER“**

salt mill  
molinillo de sal  
moulin à sel



**Mahlwerk aus Edelstahl, Mahlgrad stufenlos einstellbar**

mill in stainless steel, the grinding degree can be adjusted infinitely  
molinillo de acero inoxidable, el grado de molino se puede ajustar de modo continuo  
moulin en acier inox, la finesse de mouture se peut réglée de façon continue

	Ø cm	↑ cm
40552	6	15

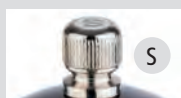

**Pfeffermühle „FRIDA“**

pepper mill  
molinillo de pimienta  
moulin à poivre

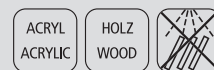

**Mahlwerk aus Carbonstahl, Mahlgrad stufenlos einstellbar**

mill in carbon steel, the grinding degree can be adjusted infinitely  
molinillo de acero al carbono, el grado de molino se puede ajustar de modo continuo  
moulin en acier de carbone, la finesse de mouture se peut réglée de façon continue

	Ø cm	↑ cm
40549	6	15,5

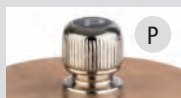

**Salzmühle „FRIDA“**

salt mill  
molinillo de sal  
moulin à sel

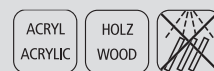

**Mahlwerk aus Edelstahl, Mahlgrad stufenlos einstellbar**

mill in stainless steel, the grinding degree can be adjusted infinitely  
molinillo de acero inoxidable, el grado de molino se puede ajustar de modo continuo  
moulin en acier inox, la finesse de mouture se peut réglée de façon continue

	Ø cm	↑ cm
40550	6	15,5





## PEPPER, - SALT MILL



### Pfeffermühle „DIAMOND“

pepper mill  
molinillo de pimienta  
moulin à poivre



**Mahlwerk aus Carbonstahl, Mahlgrad stufenlos einstellbar**

mill in carbon steel, the grinding degree can be adjusted infinitely  
molinillo de acero al carbono, el grado de molino se puede ajustar de modo continuo  
moulin en acier de carbone, la finesse de mouture se peut régler de façon continue

	Ø cm	↑ cm
40553	6	18



### Salzmühle „DIAMOND“

salt mill  
molinillo de sal  
moulin à sel



**Mahlwerk aus Edelstahl, Mahlgrad stufenlos einstellbar**

mill in stainless steel, the grinding degree can be adjusted infinitely  
molinillo de acero inoxidable, el grado de molino se puede ajustar de modo continuo  
moulin en acier inox, la finesse de mouture se peut régler de façon continue

	Ø cm	↑ cm
40554	6	18



### Pfeffermühle „GUNMETAL“

pepper mill  
molinillo de pimienta  
moulin à poivre



**Mahlwerk aus Carbonstahl, Mahlgrad stufenlos einstellbar**

mill in carbon steel, the grinding degree can be adjusted infinitely  
molinillo de acero al carbono, el grado de molino se puede ajustar de modo continuo  
moulin en acier de carbone, la finesse de mouture se peut régler de façon continue

	Ø cm	↑ cm
40555	6	15,5



### Salzmühle „GUNMETAL“

salt mill  
molinillo de sal  
moulin à sel



**Mahlwerk aus Edelstahl, Mahlgrad stufenlos einstellbar**

mill in stainless steel, the grinding degree can be adjusted infinitely  
molinillo de acero inoxidable, el grado de molino se puede ajustar de modo continuo  
moulin en acier inox, la finesse de mouture se peut régler de façon continue

	Ø cm	↑ cm
40556	6	15,5





**Pfeffermühle „ELEMENT“**

pepper mill  
molinillo de pimienta  
moulin à poivre

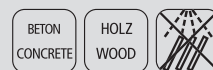

**Mahlwerk aus Carbonstahl, Mahlgrad stufenlos einstellbar**

mill in carbon steel, the grinding degree can be adjusted infinitely  
molinillo de acero al carbono, el grado de molino se puede ajustar de modo continuo  
moulin en acier de carbone, la finesse de mouture se peut réglée de façon continue

	Ø cm	↑ cm
40557	7,5	15,5



**Salzmühle „ELEMENT“**

salt mill  
molinillo de sal  
moulin à sel

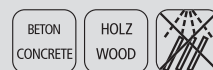

**Mahlwerk aus Edelstahl, Mahlgrad stufenlos einstellbar**

mill in stainless steel, the grinding degree can be adjusted infinitely  
molinillo de acero inoxidable, el grado de molino se puede ajustar de modo continuo  
moulin en acier inox, la finesse de mouture se peut réglée de façon continue

	Ø cm	↑ cm
40558	7,5	15,5



**Pfeffermühle „ELEMENT“**

pepper mill  
molinillo de pimienta  
moulin à poivre

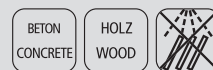

**Mahlwerk aus Carbonstahl, Mahlgrad stufenlos einstellbar**

mill in carbon steel, the grinding degree can be adjusted infinitely  
molinillo de acero al carbono, el grado de molino se puede ajustar de modo continuo  
moulin en acier de carbone, la finesse de mouture se peut réglée de façon continue

	Ø cm	↑ cm
40538	6	18

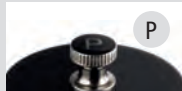

**Salzmühle „ELEMENT“**

salt mill  
molinillo de sal  
moulin á sel

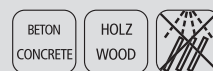

**Mahlwerk aus Edelstahl, Mahlgrad stufenlos einstellbar**

mill in stainless steel, the grinding degree can be adjusted infinitely  
molinillo de acero inoxidable, el grado de molino se puede ajustar de modo continuo  
moulin en acier inox, la finesse de mouture se peut réglée de façon continue

	Ø cm	↑ cm
40539	6	18



## PEPPER, - SALT MILL



### Pfeffer- u. Salzmühle „PROFESSIONAL“

salt / pepper mill  
molinillo de sal / pimienta  
moulin à sel / poivre



#### Mahlgrad stufenlos einstellbar

the grinding degree can be adjusted infinitely  
el grado de molino se puede ajustar de modo continuo  
la finesse de mouture se peut réglée de façon continue

	Ø cm	↑ cm	Farbe / Colour	
40540	5,5	15		pepper mill
40541	5,5	15		salt mill



### Pfeffermühle „PROFESSIONAL VINTAGE“

pepper mill  
molinillo de pimienta  
moulin à poivre



#### Deutsches Buchenholz, vintage, Mahlwerk aus Carbonstahl, Mahlgrad stufenlos einstellbar

German beechwood, vintage, mill in carbon steel,  
the grinding degree can be adjusted infinitely  
madera de haya alemana, carácter „vintage“, molinillo de acero  
al carbono, el grado de molino se puede ajustar de modo continuo  
bois de hêtre d'Allemagne, vintage, moulin en acier de carbone,  
la finesse de mouture se peut réglée de façon continue

	Ø cm	↑ cm	Farbe / Colour
40535	5,5	15	
40537	6,0	23	
40546	5,5	15	
40548	6,0	23	



### Pfeffermühle

pepper mill  
molinillo de pimienta  
moulin à poivre



#### Mahlwerk aus Carbonstahl, Mahlgrad stufenlos einstellbar

mill in carbon steel, the grinding degree can be adjusted infinitely  
molinillo de acero al carbono, el grado de molino se puede ajustar de modo continuo  
moulin en acier de carbone, la finesse de mouture se peut réglée de façon continue

	Ø cm	↑ cm	Farbe / Colour
40559	5,5	18	



### Salzmühle

salt mill  
molinillo de sal  
moulin à sel



#### Mahlwerk aus Edelstahl, Mahlgrad stufenlos einstellbar

mill in stainless steel, the grinding degree can be adjusted infinitely  
molinillo de acero inoxidable, el grado de molino se puede ajustar de modo continuo  
moulin en acier inox, la finesse de mouture se peut réglée de façon continue

	Ø cm	↑ cm	Farbe / Colour
40560	5,5	18	



**Salzmühle „PROFESSIONAL VINTAGE“**

salt mill  
molinillo de sal  
moulin à sel



**Deutsches Buchenholz, vintage, Mahlwerk aus Edelstahl, Mahlgrad stufenlos einstellbar**

German beechwood, vintage, mill in stainless steel, the grinding degree can be adjusted infinitely  
madera de haya alemana, carácter „vintage“, molinillo de acero inoxidable, el grado de molino se puede ajustar de modo continuo  
bois de hêtre d'Allemagne, vintage, moulin en acier inox, la finesse de mouture se peut régler de façon continue

	Ø cm	↑ cm	Farbe / Colour
40536	5,5	15	
40547	5,5	15	



**Pfeffermühle „PROFESSIONAL“**

pepper mill  
molinillo de pimienta  
moulin à poivre



**Mahlwerk aus Carbonstahl, Mahlgrad stufenlos einstellbar**

mill in carbon steel, the grinding degree can be adjusted infinitely  
molinillo de acero al carbono, el grado de molino se puede ajustar de modo continuo  
moulin en acier de carbone, la finesse de mouture se peut réglée de façon continue

	Ø cm	↑ cm	Farbe / Colour
40530	5,5	15	Holz / wood
40532	7,0	30	Holz / wood
40534	7,0	40	Holz / wood



Mahlgrad einstellbar  
grinder setting

	Ø cm	↑ cm	Farbe / Colour
40520	5,5	15	Holz / wood
40522	7,0	30	Holz / wood
40524	7,0	40	Holz / wood



Mahlgrad einstellbar  
grinder setting



**Salzmühle „PROFESSIONAL“**

salt mill  
molinillo de sal  
moulin à sel



**Mahlwerk aus Edelstahl, Mahlgrad stufenlos einstellbar**

mill in stainless steel, the grinding degree can be adjusted infinitely  
molinillo de acero inoxidable, el grado de molino se puede ajustar de modo continuo  
moulin en acier inox, la finesse de mouture se peut réglée de façon continue

	Ø cm	↑ cm	Farbe / Colour
40531	5,5	15	Holz / wood
40521	5,5	15	Holz / wood



# PEPPER, - SALT MILL



## Tablett

tray  
bandeja  
plateau

mit 2 Absätzen Ø 6 cm  
with 2 holes Ø 6 cm  
con 2 agujeros Ø 6 cm  
avec 2 trous Ø 6 cm



	cm	↑ cm
84039	16,5 x 8,5	1,5



## Naturschieferplatte / Untersetzer

natural slate tray  
bandeja de pizarra natural  
plateau ardoise naturelle

mit 2 Absätzen Ø 6 cm  
with 2 holes Ø 6 cm  
con 2 agujeros Ø 6 cm  
avec 2 trous Ø 6 cm



	cm	✂ mm
00971	15 x 8	6 - 9



## 2 in 1 Salz- u. Pfeffermühle

2 in 1 salt / pepper mill  
2 in 1 molinillo de sal / pimienta  
2 in 1 moulin à sel / poivre

Keramik Mahlwerk  
ceramic mechanism  
molinillo de cerámica  
broyeur en céramique



	Ø cm	↑ cm
40545	7,5	18,5



Mahlgrad einstellbar  
grinder setting

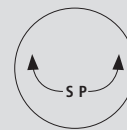

## 2 in 1 Salz- u. Pfeffermühle

2 in 1 salt / pepper mill  
2 in 1 molinillo de sal / pimienta  
2 in 1 moulin à poivre / sel

Keramik Mahlwerk  
ceramic mechanism  
molinillo de cerámica  
broyeur en céramique



	cm	↑ cm
40544	6 x 4,5	9,5



Mahlgrad einstellbar  
grinder setting

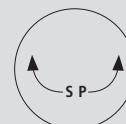



Löcher  
Ø 5 mm  
inkl.  
Staubdeckel

**Käse- oder Gewürzstreuer**

spice shaker  
botes especieros  
saupoudreuse à épices



	Ø cm	↑ cm	litr.
00775	5,5	7,5	0,15



inkl.  
Staubdeckel

**Netzstreuer**

mesh top shaker  
polvoreador, tapa con malla fina  
pot à épices, couvercle toile fine



	Ø cm	↑ cm	litr.
00776	5,5	7,5	0,15



Löcher Ø 1 mm  
inkl. Staubdeckel

**Streuer fein**

small hole shaker  
polvoreador, tapa con agujeros pequeños  
pot à épices, couvercle à petits trous



	Ø cm	↑ cm	litr.
00777	5,5	7,5	0,15



Löcher  
Ø 2,5 mm  
inkl.  
Staubdeckel

**Streuer grob**

large hole shaker  
polvoreador, tapa con agujeros grandes  
pot à épices, couvercle à grands trous



	Ø cm	↑ cm	litr.
00778	5,5	7,5	0,15



00773

00774



00781



00782



00783

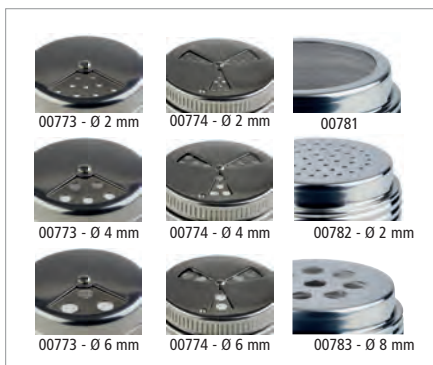

**Multistreuer**

multi-functional shaker  
salero  
saupoudreuse



	Ø cm	↑ cm	litr.
00773	6	8	0,05
00774	7	12	0,20
00781	6,5	12	0,20
00782	6,5	12	0,20
00783	6,5	12	0,20

## PEPPER, - SALT SHAKER



### Salz- und Pfefferstreuer, 2er Set

salt - and pepper shaker, 2 pcs.  
piezas de sal y pimienta, set de 2  
sel et poivre, set de 2



	Ø cm	↑ cm	pcs.	
40500	5	6,5	2	glatte Ausführung / smooth version versión recta / forme lisse
40501	5	6,5	2	geriffelte Ausführung / fluted version versión ondulada / forme ondulée
40507	6	10,0	2	



### Allzweckstreuer, 12er Set

shaker, 12 pcs.  
dosificador, set de 12  
salières/poivrières, set de 12



	cm	↑ cm	pcs.	
40504	4 x 4	10	12	13 Löcher / 13 holes 13 agujeros / 13 trous
40505	3	9	12	3 Löcher / 3 holes 3 agujeros / 3 trous



### Ministreuer, 4er Set

smaller shaker, 4 pcs.  
bodegas pequeñas, set de 4  
mini-salières, set de 4



	Ø cm	↑ cm	pcs.
40503	3,5	4	4



### Salzstreuer

salt shaker  
salero  
salière



#### Pommes-Frites Streuer mit Schraubkappe

for french fries, cover to screw  
para patatas fritas, tapa de rosca  
pour les frites, couvercle à visser

	Ø cm	↑ cm	
00779	8	17	Aluminium / aluminium aluminio / aluminium
00772	8	17	Edelstahl / stainless steel acero inoxidable / inox



**Pfeffer- & Salz-Menage „WOOD“**

salt- and pepper-menage  
salero-pimentero  
ménage sel et poivre



**matt poliert, Glasbehälter mit Edelstahl-Deckel und Deckelverschluss**  
satin polished finish, glass with stainless steel cover  
pulido acabado efecto satinado, cristal con tapa de acero inoxidable  
verre et inox mat satiné

	cm	↑ cm
40435	11,5 x 5,5	17



**Essig- & Öl-Menage „WOOD“**

oil- and vinegar-menage  
aceitera-vinagrera  
ménage huile et vinaigre



**matt poliert, Glasbehälter mit Edelstahl-Deckel und Deckelverschluss**  
satin polished finish, glass with stainless steel cover  
pulido acabado efecto satinado, cristal con tapa de acero inoxidable  
verre et inox mat satiné

	cm	↑ cm
40436	16 x 7,5	24,5



**Pfeffer-, Salz-, Essig- und Öl-Menage „WOOD“**

salt- and pepper- and oil- and vinegar-menage  
salero-pimentero & aceitera-vinagrera  
ménage sel et poivre & huile et vinaigre



**matt poliert, mit möbelschonender Unterseite**  
satin polished finish, glass with stainless steel cover  
pulido acabado efecto satinado, con tapa de acero inoxidable  
verre et inox mat satiné, avec couvercle inox

	cm	↑ cm
40437	15,5 x 12	24,5

**Salz- und Pfefferstreuer / salt - and pepper shaker / juego de sal y pimienta / set sel et poivre**

	Ø cm	↑ cm	
40438	4	9	6 Löcher - Ø 1,85 mm
40439	4	9	18 Löcher - Ø 1,35 mm

**Ersatzglas Essig / Öl / spare glass vinegar / oil / cristal de recambio con tapa „aceite & vinagre“**  
verre huile ou vinagre

	Ø cm	↑ cm	ltr.
40442	6	18,5	0,2



**mit praktischem Ausgießer**  
with no drips pourer





**Pfeffer- und Salz-Menage „ELEMENT“**

salt- and pepper-menage  
salero-pimentero  
ménage sel et poivre



**Beton-Ständer, Glasbehälter mit Edelstahl-Deckel, mit möbelschonender Unterseite**  
stand made of concrete, glass with stainless steel cover, furniture-friendly underside

soporte de hormigón, recipiente de vidrio con tapa de acero inoxidable, con base anti rayaduras  
support en béton, récipient en verre avec couvercle en acier inox, avec revêtement antirayures

	cm	↑ cm
40410	10 x 6	17



**Essig- und Öl-Menage „ELEMENT“**

oil- and vinegar-menage  
aceitera-vinagrera  
ménage huile et vinaigre



**Beton-Ständer, Glasbehälter mit Edelstahl-Deckel und tropffreiem Kunststoff-Ausgießer, mit möbelschonender Unterseite**  
stand made of concrete, glass with stainless steel cover and non-drip nozzle-spout, furniture-friendly underside

soporte de hormigón, recipiente de vidrio con tapa de acero inoxidable y sistema antigoteo, con base anti rayaduras  
support en béton, récipient en verre avec couvercle en acier inox et verseur antigoutte, avec revêtement antirayures

	cm	↑ cm
40411	14 x 8	25



**Pfeffer-, Salz-, Essig- und Öl-Menage „ELEMENT“**

salt- and pepper- and oil- and vinegar-menage  
salero-pimentero & aceitera-vinagrera  
ménage sel et poivre & huile et vinaigre



**Beton-Ständer, Glasbehälter mit Edelstahl-Deckel und Drehverschluss, mit möbelschonender Unterseite**  
stand made of concrete, glass with stainless steel cover and screw cap, furniture-friendly underside

soporte de hormigón, recipiente de vidrio con tapa de acero inoxidable y tapón de rosca, con base anti rayaduras  
support en béton, récipient en verre avec couvercle en acier inox et bouchon à vis, avec revêtement antirayures

	cm	↑ cm
40412	12,5 x 12,5	25



**Pfeffer-, Salz-, Essig- und Öl-Menage „ELEMENT“**

salt- and pepper- and oil- and vinegar-menage  
salero-pimentero & aceitera-vinagrera  
ménage sel et poivre & huile et vinaigre

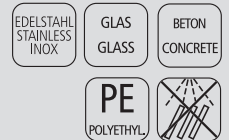

**Beton-Ständer mit Kartenhalterung, Glasbehälter mit Edelstahl-Deckel und Drehverschluss, mit möbelschonender Unterseite**  
stand made of concrete with card holder, glass with stainless steel cover and screw cap, furniture-friendly underside

soporte de hormigón con tarjetero, recipiente de vidrio con tapa de acero inoxidable y tapón de rosca, con base anti rayaduras  
support en béton avec porte-cartes, récipient en verre avec couvercle en acier inox et bouchon à vis, avec revêtement antirayures

	cm	↑ cm
40413	14 x 13,5	20



mit Kartenhalterung an der Rückseite  
with card holder at the back



**Pfeffer- & Salz-Menage „CLASSIC“**

salt- and pepper-menage  
salero-pimentero  
ménage sel et poivre



**Glasbehälter mit Edelstahl-Deckel und Drehverschluss**

glass with stainless steel cover  
vidrio con tapa de acero inoxidable con rosca  
en verre avec couvercle inox à visser

	cm	↑ cm
40310	10,5 x 6,5	16



**Pfeffer- & Salz-Menage „CLASSIC“**

salt- and pepper-menage  
salero-pimentero  
ménage sel et poivre



**Glasbehälter mit Edelstahl-Deckel und Drehverschluss**

glass with stainless steel cover  
vidrio con tapa de acero inoxidable con rosca  
en verre avec couvercle inox à visser

	Ø cm	↑ cm
40320	10,5	16



**Menage „CLASSIC“**

menage  
menage  
ménage



**Glasbehälter mit Edelstahl-Deckel und tropffreiem Kunststoff-Ausgießer**

with stainless steel cover and non-drip nozzle-spout  
vidrio con tapa inox y sistema antigoteo  
verre avec couvercle inox et verseur antigoutte

	cm	↑ cm	ltr.
40440	14,5 x 8,5	23	0,2
40450	17,5 x 10,5	23	

**Ersatzglas mit Deckel / spare glass with cover / vidrio con tapa / verre + couvercle**

	Ø cm	↑ cm	
40312	4	9	18 Löcher - Ø 1,35 mm
40311	4	9	6 Löcher - Ø 1,85 mm

**Ersatzglas mit Deckel „Essig & Öl“ / spare glass with cover „vinegar & oil“ / cristal de recambio con tapa „vinegar & oil“ / verre huile ou vinaige avec couvercle inox et verseur antigoutte**

	Ø cm	↑ cm	ltr.
40441	6	18,5	0,2

**Ersatzglas mit Deckel „Zahnstocher“ / spare glass with cover „toothpick“ / porta-palillos vidrio con tapa / verre à cure-dents + couvercle**

	Ø cm	↑ cm
40313	4	9



**Senftöpfchen, 2er Set**

mustard glass, 2 pcs. set  
piezas vasos mostaza, set de 2  
verres à moutarde, set de 2



**inkl. Löffel und Edelstahl-Deckel**

incl. spoons and covers  
incluye cucharas y tapas  
cuillères et couvercles inclus

	Ø cm	↑ cm	pcs.
40415	5	6	2



**Menage „ECONOMIC“**

menage  
menage  
ménage



**Glasbehälter mit Edelstahl-Deckel und Drehverschluss**

glass with stainless steel cover  
cristal con tapa inox a rosca  
en verre avec couvercle inox à visser

	cm	↑ cm
40455	8 x 4	13



**Menage „ECONOMIC“**

menage  
menage  
ménage



**Glasbehälter mit Edelstahl-Deckel und Drehverschluss**

glass with stainless steel cover  
cristal con tapa inox a rosca  
en verre avec couvercle inox à visser

	cm	↑ cm
40457	8 x 8	12

**Glas für Senf / glass for mustard / vaso de cristal para mostaza / pot verre seul pour la moutarde**

40464



40458

**Menage „ECONOMIC“**

menage  
menage  
ménage



**Glasbehälter mit Edelstahl-Deckel und tropffreiem Kunststoff-Ausgießer**

glasses with stainless steel cover and non-drip nozzle-spout  
cristales con tapa de acero inoxidable y sistema antigoteo  
en verre avec couvercle inox et insert plastique antigoutte

	cm	↑ cm
40458	11,5 x 5,5	22
40460	11,0 x 10,5	22

**Pfeffer- oder Salz-Glasstreuer / pepper- or salt-glass with cover salero o pimentero de cristal con tapa / salière ou poivrière seule en verre avec couvercle inox**

	Ø cm	↑ cm
40461	3	9

**Essig- oder Öl-Glasbehälter / oil- or vinegar-glass with cover / aceitera-vinagrera con tapa bouteille huile ou vinaigre seule en verre et couv. inox**

	Ø cm	↑ cm
40462	4,5	16

**Glas für Zahnstocher / glass for tooth picks / vaso de cristal para palillos de dientes porte-cure-dents env erre**

	Ø cm	↑ cm
40463	3	6



40460



**Menage „PRO“**

menage  
menage  
ménage



**matt poliert, Glasbehälter mit Edelstahl-Deckel und tropffreiem Kunststoff-Ausgießer**

satin polished finish, glass with stainless steel cover and non-drip nozzle-spout

inox satinado, vidrio, sistema antigoteo

inox poli mat satiné et verre, insert plastique antigoutte

	cm	↑ cm
40476	12,0 x 8,0	19
40478	12,5 x 11,0	19
40480	13,0 x 11,0	19

**Pfeffer- oder Salz-Glasstreuer / pepper- or salt-glass with cover / salero o pimentero de cristal con tapa**  
salière ou poivrière seule en verre avec couvercle inox

	Ø cm	↑ cm
40461	3	9

**Essig- oder Öl-Glasbehälter / oil- or vinegar-glass with cover / aceitera-vinagrera con tapa**  
bouteille huile ou vinaigre seule en verre et couv. inox

	Ø cm	↑ cm
40462	4,5	16



**Menage „PRO“**

menage  
menage  
ménage



**matt poliert, Glasbehälter mit Edelstahl-Deckel und Drehverschluss**

satin polished finish, glass with stainless steel cover

inox satinado, vidrio y tapas con rosca

inox poli mat satiné et verre, couvercle à visser

	cm	↑ cm
40470	8,5 x 5,7	11,5
40472	9,2 x 8,5	11,5
40474	10,0 x 10,0	11,5





**Parmesan-Menage „CLASSIC“**

cheese dish  
quesera parmesano  
service à parmesan

hochglanzpoliert, inkl. Löffel  
mirror polished finish, with spoon  
pulido efecto espejo, con bol cristal y cuchara  
brillant, avec bol verre et cuillère



	Ø cm	↑ cm
40330	10,5	7

Ersatzbehälter / sparecontainer / bol de recambio / bol de rechange

	Ø cm
40331	10,5



**Parmesan-Menage „PROFI“**

cheese dish  
quesera parmesano  
service à parmesan



	Ø cm	↑ cm
40424	9	5,5

Ersatzbehälter / sparecontainer / bol de recambio / bol de rechange

	Ø cm
40331	10,5



**Parmesan-Menage „PRO“**

cheese dish  
quesera parmesano  
service à parmesan

matt poliert, inkl. Löffel  
satin polished finish, with spoon  
pulido mate satinado, con bol cristal y cuchara  
mat satiné, avec bol verre et cuillère



	Ø cm	↑ cm
40482	10,5	13

Ersatzbehälter / sparecontainer / bol de recambio / bol de rechange

	Ø cm
40331	10,5



**Parmesan-Menage „ECONOMIC“**

cheese dish  
quesera parmesano  
service à parmesan

inkl. Kunststofflöffel  
with spoon  
con cuchara  
avec cuillère



	Ø cm	↑ cm
40453	10,5	7

Ersatzbehälter / sparecontainer / bol de recambio / bol de rechange

	Ø cm
40454	10,5



**Essig- & Öl-Menage**  
oil- and vinegar-menage  
aceitera-vinagrera  
ménage huile et vinaigre



**Glasbehälter mit Deckel und tropffreiem PE-Ausgießer**  
glass with lid and non-drip nozzle-spout  
recipiente de cristal con tapa y sistema antigoteo  
pot en verre avec couvercle et système plastique antigoutte

	cm	↑ cm	ltr.
40445	10,5 x 5,5	24	0,12
40446	13,0 x 7,0	34	0,50



tropffreier Ausgießer  
non-drip spout



**Gewürzständer**  
condiment stand  
soporte salsas y condimentos  
porte condiments et sauces



**matt poliert, Lieferung ohne Deko**  
satin polished finish  
acabado pulido efecto satinado  
poli mat satiné

	Ø cm	↑ cm
40300	19	20



**Menage**  
menage  
menage  
ménage



**drehbares Gestell, Glasbehälter mit Edelstahl-Deckel und Drehverschluss**  
rotating stand, glass with stainless steel cover  
soporte giratorio con piezas de vidrio y tapas inox  
tournant, avec pièces en verre et couvercle inox

	Ø cm	↑ cm
40485	16	20

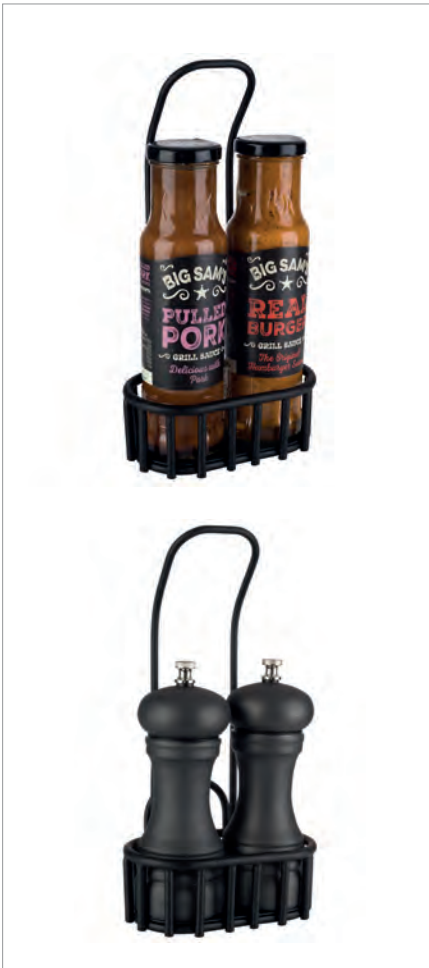

**Ständer „URBAN“**

serving stand  
soporte 2 botellas  
support 2 bouteilles

Metall schwarz, mit Kartenhalterung  
metal black, with card holder  
metal negro, con tarjetero  
métal noir, avec porte-cartes



	cm	↑ cm
40414	13 x 8,5	25



mit Kartenhalterung an der Rückseite  
with card holder at the back

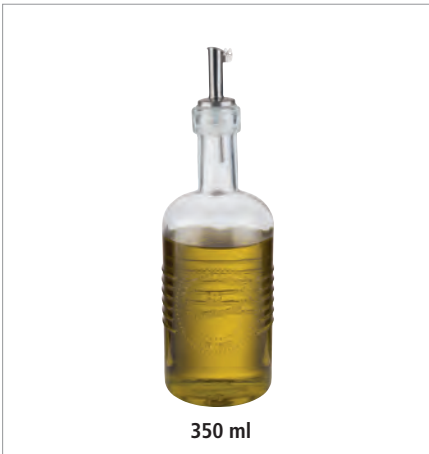

350 ml

**Essig- & Öl-Flasche „OLD FASHIONED“**

oil- and vinegar bottle  
botella de aceite y vinagre  
bouteille d'huile et vinaigre

Glasflasche, Edelstahl - Ausgießer mit Deckel  
glass bottle, stainless steel spout with lid  
botella de vidrio, pico verteder de acero inoxidable con tapa  
bouteille en verre, bec verseur en acier inox avec couvercle



	Ø cm	↑ cm	ltr.
40511	7	22	0,35



93308  
200 ml

93309

**Spritzflasche inklusive Ausgießer**

squeeze bottle with nozzle  
botella exprimible con dosificador  
flacon pulvérisateur avec bec verseur

ideal für Bitter-Liköre, Essig, Öl  
perfect for bitter liqueur, vinegar, oil  
perfecto para licores amargos, vinagre, aceite  
idéal pour liqueur amère, vinaigre, huile



	cm	↑ cm	ltr.
93308	6 x 5	20	0,2

Ausgießer passend für Spritzflasche / nozzle suitable for squeeze bottle / dosificador apto para botella exprimible / bec verseur approprié pour flacon pulvérisateur

	Ø cm	↑ cm
93309	2,5	5,5



350 ml

**Zuckerdosierer „OLD FASHIONED“**

sugar dispenser  
azucarero  
sucrier



**Schraubdeckel aus Edelstahl, mit Dosierklappe**  
cover stainless steel with dosing flap  
tapa de acero inoxidable, con cierre dosificador  
couvrecl en acier inox, avec couvercle de dosage

	Ø cm	↑ cm	ltr.
40510	7,5	14	0,35



mit Dosierklappe  
with dosing flap



300 ml

**Zuckerdosierer**

sugar dispenser  
azucarero  
sucrier



**Schraubdeckel aus Edelstahl**  
cover stainless steel  
tapa de acero inoxidable  
couvrecl en acier inox

	Ø cm	↑ cm	ltr.
00766	8,5	15	0,3

Ersatzglasbehälter / spare glass-container / contenedor de repuesto / récipient verre de rechange

00768			
-------	--	--	--



40490  
150 ml

40494  
250 ml

**Zuckerdosierer**

sugar dispenser  
azucarero  
sucrier



**Schraubdeckel aus Edelstahl, mit Dosierrohr**  
cover stainless steel with dosingtube  
tapa de acero inoxidable y tubo dosificador  
couvrecl en acier inox et tube doseur

	Ø cm	↑ cm	ltr.
40490	8,5	12	0,15
40494	8,5	15	0,25

Ersatzglasbehälter / spare glass-container / contenedor de repuesto / récipient verre de rechange

	fits to
40498	40490
40499	40494



## SUGAR DISPENSER



200 ml

### Zuckerdosierer

sugar dispenser  
azucarero  
sucrier



Schraubdeckel aus Edelstahl mattiert, mit Dosierrohr

cover stainless steel matt polished, with dosing tube  
tapa de rosca de acero inoxidable mate y tubo dosificador  
couvercle à vis en acier inox mat et tube doseur

	Ø cm	↑ cm	ltr.
40509	6	14,5	0,20



40486 250 ml

40506 320 ml

### Zuckerdosierer

sugar dispenser  
azucarero  
sucrier



Schraubdeckel aus Edelstahl, mit Dosierrohr

cover stainless steel, with dosing tube  
tapa de acero inoxidable y tubo dosificador  
couvercle en acier inox et tube doseur

	Ø cm	↑ cm	ltr.
40486	8,0	15	0,25
40506	7,5	17	0,32



250 ml

### Allzweckgießer

pourer  
dosificador  
doseur



Schraubdeckel aus Edelstahl und Kunststoff, mit Dosierklappe

cover stainless steel and plastic, with dosing flap  
tapa de acero inoxidable y plástico, con cierre dosificador  
couvercle en acier inox et plastique, avec couvercle de dosage

	Ø cm	↑ cm	ltr.
40488	8	12,5	0,25



300 ml

### Allzweckgießer

pourer  
bote vertedor universal  
pot verseur universel



für Honig, Kaffeesahne, etc., Schraubdeckel aus Edelstahl

for honey, cream, etc., cover stainless steel  
para miel, crema, etc., tapa de acero inoxidable  
pour le miel, le lait, la crème, etc., couvercle en acier inox

	Ø cm	↑ cm	ltr.
00765	8,5	13,5	0,3

Ersatzglasbehälter / spare glass-container / contenedor de repuesto / récipient verre de rechange

00768



320 ml

**Zuckerdosierer**sugar dispenser  
azucarero  
sucrier**Schraubdeckel mit Klappe aus Edelstahl, mit Dosierklappe**cover stainless steel, with dosing flap  
tapa acero inoxidable, con cierre dosificador  
couvercle inox, avec couvercle doseur

	Ø cm	↑ cm	ltr.
40487	7,5	13,5	0,32



200 ml

**Zuckerdosierer**sugar dispenser  
azucarero  
sucrier**mit Schraubverschluss, Dosier-Rohr Ø 15 mm**cover and dosingtube Ø 15 mm  
con tapa y tubo dosificador Ø 15 mm  
couvercle avec tube doseur Ø 15 mm

	Ø cm	↑ cm	ltr.
40508	6,5	14,5	0,20



170 ml

**Zuckerspender**sugar pourer / milk jug  
dispensador de azúcar  
sucrier doseur**matt poliert**satin polished finish  
pulido efecto satinado  
intérieur et extérieur poli mat

	Ø cm	↑ cm	ltr.
10316	5	15	0,17

**Zuckerkugel**sugar pot  
azucarero  
sucrier**hochglanzpoliert, mit Rolldecke**mirror polished finish, rolltop cover  
pulido acabado brillante, tapa abatible  
brillant, couvercle abattant

	Ø cm	↑ cm
00033	13,5	15

**BUTTER DISH · EGG HOLDER**



**Butterservierer**  
butter dish  
mantequillera  
beurrer



	cm	↑ cm	ltr.
15925	Ø 9	9	0,07
15926	9 x 9	9	0,075



**Butterservierer**  
butter dish  
mantequillera  
beurrer



hochglanzpoliert  
mirror polished finish  
acabado brillante  
poli brillant

	Ø cm	↑ cm	ltr.
15921	9	7	0,06



**Schale „ENAMELWARE“**  
bowl  
cuenco  
bol



	cm	↑ cm	ltr.
40667	16 x 12,0	3,5	0,20
40668	18 x 13,5	4,0	0,35



**Kühlschrank-Butterdose**  
refrigerator butter dish  
mantequillera para nevera  
boîte à beurre pour le frigo



	cm	↑ cm
00063	16 x 9,5	5,5



**Eierbecher**  
egg holder  
huevera  
coquetier



	Ø cm	↑ cm
00032	8,5	2



**Fondue und Feuerzangenbowle-Set „TWO IN ONE“**

fondue and fire punch bowl set  
set para fondue o ponche caliente  
service à fondue et à punch



13-teiliges Set aus Edelstahl bestehend aus:  
1 Topf, 1 Rechaud, 1 Spritzschutz, 1 Untersetzer, 1 Schöpfkelle, 1 Feuerzange,  
1 Pastenbrenner, 6 Fonduegabeln

13-piece stainless steel set consisting of:  
1 pot, 1 rechaud, 1 splash guard, 1 coaster, 1 ladle, 1 fire tongs,  
1 paste burner, 6 fondue forks

set de 13 piezas de acero inoxidable compuesto por:  
1 olla, 1 rechaud, 1 protector contra salpicaduras, 1 trébede, 1 cazo,  
1 pinza para el fuego, 1 quemador de pasta, 6 tenedores de fondue

set de 13 pièces en acier inox comprenant:  
1 marmite, 1 rechaud, 1 pare-éclaboussures, 1 dessous de plat, 1 louche, 1 pince à feu,  
1 brûleur à pâte, 6 fourchettes à fondue

	Ø cm	↑ cm	ltr.
65060	22	23	2,2



**Kaviarkühler**

caviar cooler  
enfriador de caviar  
rafraîchisseur de caviar



4-teilig: Glasschale Ø 10 cm / 4 pcs.: glass bowl Ø 10 cm / set de 4: bol Ø 10 cm  
set de 4: bol Ø 10 cm

	Ø cm	↑ cm
01699	18	12



**Butter- und Saucenwärmer**

butter and sauce pan warmer  
calentador de mantequilla y salsa  
réchaud à beurre et sauce



Saucentopf mit Ausgießer + Deckel + Gestell (passend für 1 Teelicht)

pan with spout + lid + riser (for 1 light)

cacerola + tapadera + soporte (para 1 vela)

petite casserole avec bec verseur + couvercle + support (pour 1 bougie)

	Ø cm	↑ cm	ltr.	Griff / handle cm
35350	14	16	0,7	13,5



**Spießständer / Spieße**

espetada and kebab skewer rack / skewer  
soporte para brochetas  
support pour brochettes



zum Servieren von Fleischspießen bis 40 cm, Gestell aus 8 mm Edelstahl

to serve skewers up to 40 cm, wire stainless steel 8 mm

para servir brochetas de carne hasta 40 cm, grosor del alambre 8 mm, inox

pour présenter les brochettes long. maxi 40 cm, fil 8 mm, inox

	Ø cm	↑ cm	
75001	22,0	46	
75002	0,3	40	4er Set / 4 pcs. set





# VINTAGE

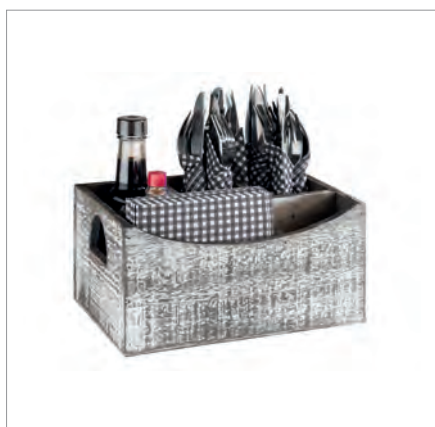

## Table Caddy „VINTAGE“

table caddy  
caddy de mesa  
caddy de table



**unterteilt in 5 Fächer**  
divided into 5 compartments  
dividido en 5 compartimentos  
divisé en 5 compartiments

	cm	↑ cm
11608	22 x 15,5	11,5



## Table Caddy „VINTAGE“

table caddy  
caddy de mesa  
caddy de table



**unterteilt in 7 Fächer**  
divided into 7 compartments  
dividido en 7 compartimentos  
divisé en 7 compartiments

	cm	↑ cm
11609	25,5 x 15,5	11,5



## Table Caddy „VINTAGE“

table caddy  
caddy de mesa  
caddy de table



**unterteilt in 4 Fächer, mit Tragegriff**  
divided into 4 compartments, with handle  
dividido en 4 compartimentos, con asa  
divisé en 4 compartiments, avec poignée

	cm	↑ cm
11610	22 x 15,5	22



**Table Caddy „VINTAGE“**

table caddy  
caddy de mesa  
caddy de table



	cm	↑ cm
11612	15 x 15	10



**Table Caddy „VINTAGE“**

table caddy  
caddy de mesa  
caddy de table



**herausnehmbare Aufteilung, 6 Fächer (7,5 x 7,5 cm)**  
separation removable, 6 compartments (7,5 x 7,5 cm)  
separadores amovibles, 6 compartimentos (7,5 x 7,5 cm)  
séparateurs amovibles, 6 compartiments (7,5 x 7,5 cm)

	cm	↑ cm
11638	27 x 17	10



**Table Caddy „ELEMENT“**

table caddy  
caddy de mesa  
caddy de table



**Beton, mit möbelschonender Unterseite**  
concrete, furniture-friendly underside  
hormigón, con base anti rayaduras  
béton, avec revêtement antirayures

	cm	↑ cm	inner size cm
11647	16,5 x 16	6,5	14,5 x 14



**Table Caddy „ELEMENT“**

table caddy  
caddy de mesa  
caddy de table



**Beton, mit möbelschonender Unterseite, 2 Löcher je 6,5 cm**  
concrete, furniture-friendly underside, 2 holes each 6.5 cm  
hormigón, con base anti rayaduras, 2 agujeros cada uno 6,5 cm  
béton, avec revêtement antirayures, 2 trous de 6,5 cm chacun

	cm	↑ cm	inner size cm
11648	23,5 x 16	6,5	14,5 x 14

## TABLE CADDY



### Table Caddy „ACACIA“

table caddy  
caddy de mesa  
caddy de table



Akazienholz, 3-Fächer

Fach 1+3: 11,5 x 5,5 cm / Fach 2: 12,0 x 11,5 cm

acacia wood, 3 compartments

compartment 1+3: 11,5 x 5,5 cm / compartment 2: 12,0 x 11,5 cm

madera de acacia, 3 compartimentos

compartimento 1+3: 11,5 x 5,5 cm / compartimento 2: 12,0 x 11,5 cm

bois d'acacia, 3 compartiments

compartiments 1+3: 11,5 x 5,5 cm / compartiment 2: 12,0 x 11,5 cm

	cm	↑ cm
40403	27,5 x 13,5	24

passende Brottasche / suitable bread basket / panera a juego / corbeille assortie

	cm	↑ cm	Farbe / Colour
30355	12 x 11,5	11,5	
30356	12 x 11,5	11,5	



### Table Caddy

table caddy  
caddy de mesa  
caddy de table



Akazienholz, 2-Fächer

acacia wood, 2 compartements

madera de acacia, 2 compartimentos

bois d'acacia, 2 compartiments

	cm	↑ cm	inner size cm
40405	25 x 15	18	21,5 x 8



### Table Caddy „VINTAGE“

table caddy  
caddy de mesa  
caddy de table



Holz, 2-Fächer (13,5 x 6 cm)

2 compartments (13,5 x 6 cm)

2 compartimentos (13,5 x 6 cm)

2 compartiments (13,5 x 6 cm)

	cm	↑ cm	inner size cm
40404	15,5 x 15,5	15	13,5 x 6



### Holzbox „WOODY“

woodbox  
caja madera  
base bois



Akazienholz, 4-Fächer

acacia wood, 4 compartements

madera de acacia, 4 compartimentos

bois d'acacia, 4 compartiments

	cm	↑ cm	inner size cm
11649	36 x 14	12,5	12,5 x 8





**Holzbox „TABLE“**

woodbox  
caja madera  
base bois



**Akazienholz, 3 Fächer (6,5 x 6,5 cm)**

acacia wood, 3 compartments (6,5 x 6,5 cm)  
madera de acacia, 3 compartimentos (6,5 x 6,5 cm)  
bois d'acacia, 3 compartiments (6,5 x 6,5 cm)

	cm	↑ cm	inner size cm
11727	23,5 x 8,5	4,5	6,5 x 6,5 je Fach / each compartment

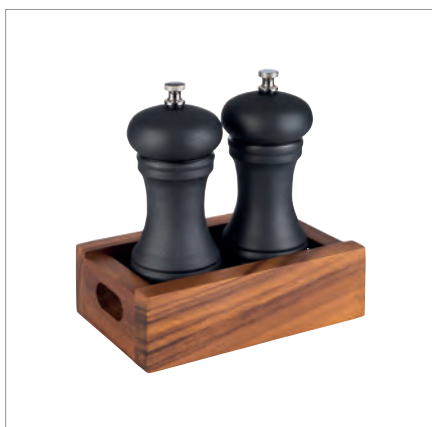

**Holzbox „TABLE“**

woodbox  
caja madera  
base bois



**Akazienholz natur**

acacia wood nature  
madera de acacia natural  
bois d'acacia naturel

	cm	↑ cm	inner size cm
11726	15,0 x 9,5	5	12 x 6,5



**Table Caddy**

table caddy  
caddy de mesa  
caddy de table



**Akazienholz**

acacia wood  
madera de acacia  
bois d'acacia

	cm	↑ cm	inner size cm
11625	23 x 10	10	22,5 x 6



**Holzbox „WOODY“**

woodbox  
caja madera  
base bois



**Akazienholz**

acacia wood  
madera de acacia  
bois d'acacia

	cm	↑ cm	inner size cm
11650	15,0 x 15	5,5	13 x 13
11651	22,5 x 15	5,5	13,5 x 13 / 6,5 x 13



## CANDLE HOLDER



### Kerzenleuchter

candle holder  
candelabro  
chandelier



hochwertige Gastro Ausführung, mit möbelschonender Unterseite

heavy quality, with non-scratching undersurface

alta calidad, con base anti raya duras

haute qualité, avec revêtement antirayures

	cm	↑ cm	
04001	27,5 x 27,5	25	5-flammig / 5-lids / 5 ramas / 5 branches
04002	27,5 x 11,0	25	3-flammig / 3-lids / 3 ramas / 3 branches
	Ø cm	↑ cm	
04003	11	22	1-flammig / 1 lid / 1 rama / 1 branche
04004	11	10	1-flammig / 1 lid / 1 rama / 1 branche



### Kerzenleuchter, 2er Set

candle holder, 2 pcs.  
candelabros, set de 2  
chandeliers, set de 2



mit möbelschonender Unterseite

with non-scratching undersurface

con base anti rayaduras

avec revêtement antirayures

	Ø cm	↑ cm	pcs.
04008	6	7	2



### Kerzenleuchter

candle holder  
candelabro  
chandelier



extra schwerer Fuß, verchromt, mit möbelschonender Unterseite

heavy foot, chrome plated, with non-scratching undersurface

pie pesado, asa cromado, con base anti rayaduras

pie lourd, chromé, avec revêtement antirayures

	Ø cm	↑ cm	Farbe / Colour
04020	10	11	—
04021	10	16	—

**Kerzenleuchter „CLASSIC“, 2er Set**

candle holder, 2 pcs.  
candelabros, set de 2  
chandeliers, set de 2



mit möbelschonender Unterseite  
with non-scratching undersurface  
con base anti rayaduras  
avec revêtement antirayures

	Ø cm	↑ cm	pcs.
04035	10	20,5	2

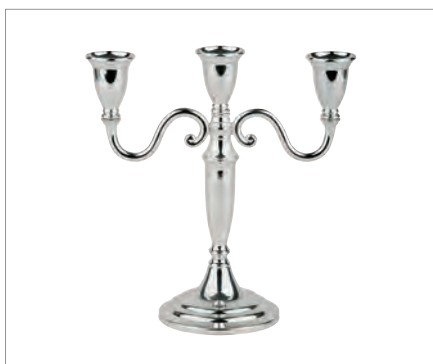
**Kerzenleuchter „CLASSIC“**

candle holder  
candelabro  
chandelier



mit möbelschonender Unterseite  
with non-scratching undersurface  
con base anti rayaduras  
avec revêtement antirayures

	cm	↑ cm	
04036	22 x 10	22,5	3-flammig / 3-lids / 3 ramas / 3 branches

**Kerzenleuchter „CLASSIC“**

candle holder  
candelabros  
chandelier



mit möbelschonender Unterseite  
with non-scratching undersurface  
con base anti rayaduras  
avec revêtement antirayures

	cm	↑ cm	
04037	22 x 22	24	5-flammig / 5-lids / 5 ramas / 5 branches

**Kerzenleuchter „XL“**

candle holder  
candelabro  
grand chandelier



extra hoch und schwer, mit möbelschonender Unterseite  
extra high and heavy, with non-scratching undersurface  
pesado y de alta calidad, con base anti rayaduras  
lourd et de haute qualité, avec revêtement antirayures

	cm	↑ cm	
04005	35 x 13	39	3-flammig / 3-lids / 3 ramas / 3 branches

**Kerzenleuchter „XL“**

candle holder  
candelabro  
grand chandelier



extra hoch und schwer, mit möbelschonender Unterseite  
extra high and heavy, with non-scratching undersurface  
pesado y de alta calidad, con base anti rayaduras  
lourd et de haute qualité, avec revêtement antirayures

	cm	↑ cm	
04006	35 x 35	39	5-flammig / 5-lids / 5 ramas / 5 branches

## CANDLE HOLDER



### Windlichter, 2er Set

wind lights, 2 pcs.  
portavelas antiviento, set de 2  
porte-bougies anti-vent, set de 2



**matt poliert, Gläser satiniert, mit möbelschonender Unterseite**  
satin polished finish, glasses satin, with non-scratching undersurface  
pulido acabado efecto satinado, cristales satinados, con base anti rayaduras  
inox mat satiné et verre mat, avec revêtement antirayures

	Ø cm	↑ cm	pcs.
03020	5	15	2

Ersatzglas / spare glass / cristal de recambio / verre de rechange

03025



### Windlichter „ELEMENT“, 2er Set

wind lights, 2 pcs.  
portavelas antiviento, set de 2  
porte-bougies anti-vent, set de 2



**Beton, Gläser klar, mit möbelschonender Unterseite**  
concrete, glass clear, with non-scratching undersurface  
hormigón, vidrio transparente, con base anti rayaduras  
bèton, verre transparente, avec revêtement antirayures

	Ø cm	↑ cm	pcs.
03038	6	8	2

Ersatzglas / spare glass / vidrio de recambio solo / verre de rechange transparent, seul

	Ø cm	↑ cm
03098	6	5



### Windlicht „ELEMENT“

wind light  
porta vela  
porte-bougie



**Beton, Glas klar, mit möbelschonender Unterseite**  
concrete, glass clear, with non-scratching undersurface  
hormigón, vidrio transparente, con base anti rayaduras  
bèton, verre transparente, avec revêtement antirayures

	Ø cm	↑ cm
03039	7,5	13

Ersatzglas / spare glass / vidrio de recambio solo / verre de rechange transparent, seul

	Ø cm	↑ cm
03099	7,5	9



**Vase mit Glaseinsatz „ELEMENT“**

flower vase with glass insert  
 florero con tubo de cristal  
 vase soliflor avec verre



**Beton, Glas klar, mit möbelschonender Unterseite, inkl. 2 Ersatzgläsern**  
 concrete, clear glass, furniture-friendly underside, incl. 2 spare glasses  
 hormigón, cristal incoloro, con base anti rayaduras, incl. 2 tubos de repuesto  
 béton, verre transparente avec revêtement antirayures y compris 2 verres de rechange

	cm	↑ cm	ml
04010	10 x 4,5	12,5	25



**Ersatzglas / spare glass / tubo de recambio / verre de rechange**

	Ø cm	↑ cm	ml
04011	2,5	11	25



**Vase**

flower vase  
 florero  
 vase soliflor



**Edelstahl-Look, Zinkdruckguss, vernickelt, lackiert, anlaufgeschützt, schwere Ausführung**  
 stainless steel look, heavy zink alloy, nickel plated, laquered  
 aspecto acero, acabado satinado, alta calidad  
 aspect inox, fini mat satiné, bonne qualité

	Ø cm	↑ cm	kg
04015	4,0	16,5	0,17
04016	4,5	20,0	0,20



**Vase**

flower vase  
 florero  
 vase soliflor



**Edelstahl-Look, Zinkdruckguss, vernickelt, lackiert, anlaufgeschützt, schwere Ausführung**  
 stainless steel look, heavy zink alloy, nickel plated, laquered  
 aspecto acero, acabado satinado, alta calidad  
 aspect inox, fini mat satiné, bonne qualité

	Ø cm	↑ cm	kg
04017	6,5	18	0,36





Die umgelegten und angenähten Kanten machen diese Tischsets besonders robust. Geliefert in einer 6er Einheit.

The folded and sewn edges make these table sets particularly robust. Delivered in a packing unit of 6 pieces.

Los bordes doblados y cosidos des los mantelitos los hacen especialmente resistentes. Se entregan en una unidad de embalaje de 6 piezas.

Les bords repliés et cousus rendent ces sets de table en particulièrement robustes. Livré dans un emballage de 6 pièces.



### Warenträger - Tischsets

display for table sets  
expositor para mantelinas de mesa  
présentoir pour sets de table

12 Einschubfächer, komplett auf Rollen, 2 Feststellrollen, Lieferung demontiert

12 shelves, on rolls, 2 rolls to fix, delivery unassembled

12 niveles, 4 ruedas, desmontado (montaje fácil)

12 niveaux, 4 roues, livré démonté

	cm	↑ cm
00401	39,5 x 45	165



### Tischset Feinband

placemat fine band  
mantelín cinta fina  
set de table, tressage fin



	cm		VE / unit
60037	45 x 33	gold / gold	6
60038	45 x 33	beige braun / beige brown	6
60040	45 x 33	blau / blue	6

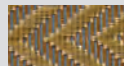

60037 - gold

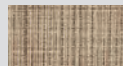

60038 - beige brown

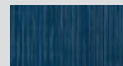

60040 - blue



### Tischset Feinband „TAO“

placemat fine band  
mantelín cinta fina  
set de table, tressage fin



	cm		VE / unit
60502	45 x 33	grau, beige / grey, beige	6
60503	45 x 33	beige / beige	6
60505	45 x 33	braun / brown	6



60502 - grey, beige



60503 - beige



60505 - brown



60044 - grey

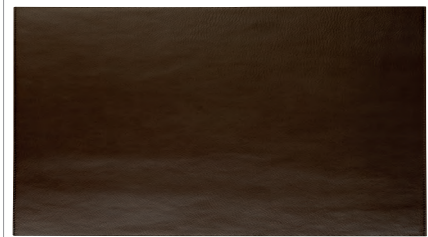

60045 - brown

**Tischset „KUNSTLEDER“**

placemat  
mantelín  
set de table

**Kunstleder**  
imitation leather  
imitación de cuero  
similicuir



	cm		VE / unit
60044	45 x 32,5	grau / grey	6
60045	45 x 32,5	braun / brown	6
60046	45 x 32,5	schwarz / black	6

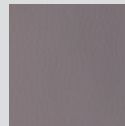

60044 - grey

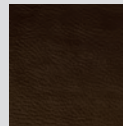

60045 - brown

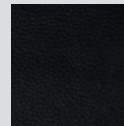

60046 - black

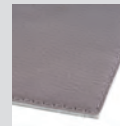

mit Naht rundherum

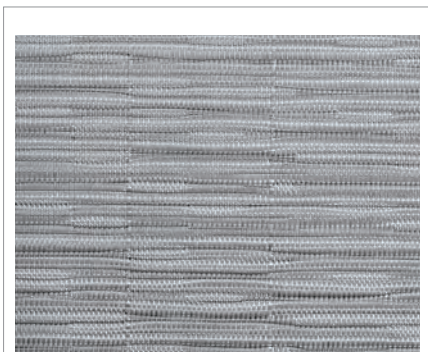

60525 - white

**Tischset Schmalband**

placemat smallband  
mantelín cinta estrecha  
set de table tressage étroit



	cm		VE / unit
60525	45 x 33	weiß / white	6
60526	45 x 33	gold / gold	6
60527	45 x 33	silber / silver	6
60528	45 x 33	grün / green	6



60525 - white

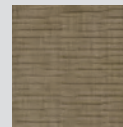

60526 - gold



60527 - silver

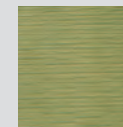

60528 - green



60535 - gold



60536 - copper

**Tischset „CROCO“**

placemat  
mantelín  
set de table

**rutschhemmende Unterseite**  
slip resistant underside  
antideslizante por debajo  
dessous antiglisse



	cm		VE / unit
60535	45 x 30	gold / gold	6
60536	45 x 30	kupfer / copper	6
60537	45 x 30	braun / brown	6



60535 - gold

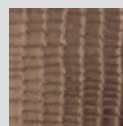

60536 - copper

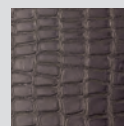

60537 - brown



## TABLE SET

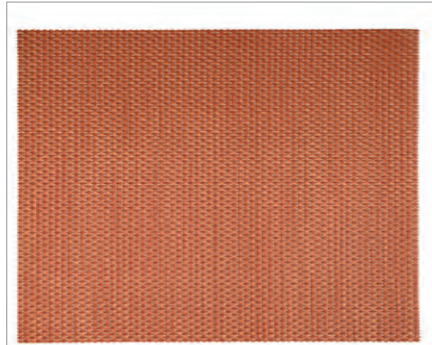

60018 - candyred

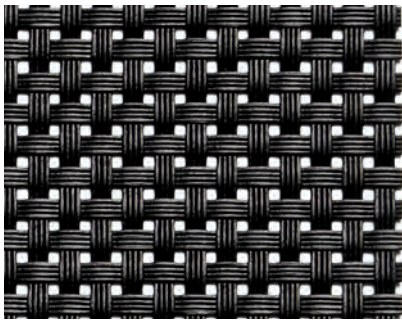

60012 - black

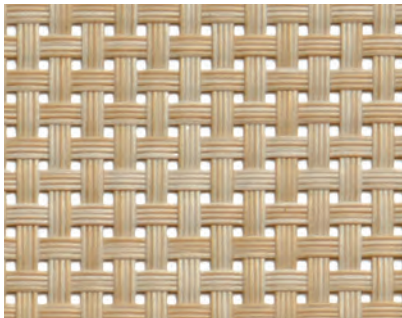

60014 - beige

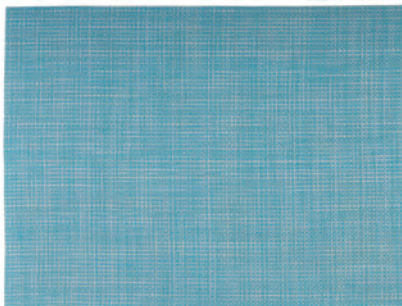

60041 - light blue, white

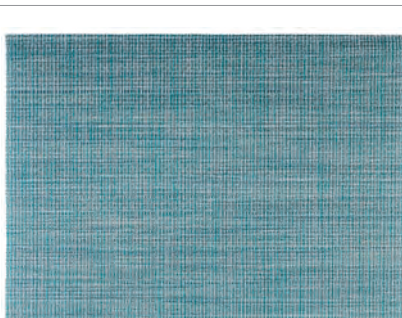

60042 - turquoise, green, white

### Tischset Schmalband placemat smallband mantelín cinta estrecha set de table tressage étroit



	cm		VE / unit
60002	45 x 33	hellblau / light blue	6
60018	45 x 33	candyrot / candyred	6
60012	45 x 33	schwarz / black	6
60014	45 x 33	beige / beige	6
60015	45 x 33	silbergrau / silvergrey	6
60016	45 x 33	grün / green	6
60019	45 x 33	beige braun / beige brown	6
60522	45 x 33	hellorange / light orange	6
60520	45 x 33	schwarz weiß / black white	6
60521	45 x 33	apfelgrün / apple green	6
60523	45 x 33	violett / purple	6
60524	45 x 33	platin / platinum	6
60041	45 x 33	hellblau, weiß / light blue, white	6

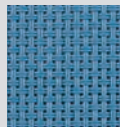

60002 - light blue

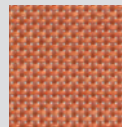

60018 - candyred

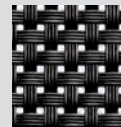

60012 - black



60014 - beige



60015 - silvergrey



60016 - green



60019 - beige brown



60522 - light orange



60520 - black white

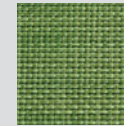

60521 - apple green

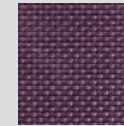

60523 - purple

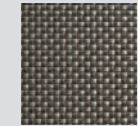

60524 - platinum

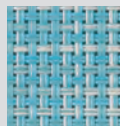

60041 - light blue, white

### Tischset Feinband placemat fine band mantelín cinta fina set de table, tressage fin



	cm		VE / unit
60042	45 x 33	türkis, grün, weiß / turquoise, green, white	6
60509	45 x 33	Mosaik schwarz, grau / black, grey	6
60512	45 x 33	schwarz, grau / black, grey	6
60542	45 x 33	rot / red	6



60042 - turquoise, green, white

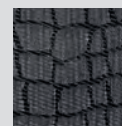

60509 - black, grey

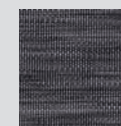

60512 - black, grey

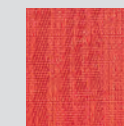

60542 - red

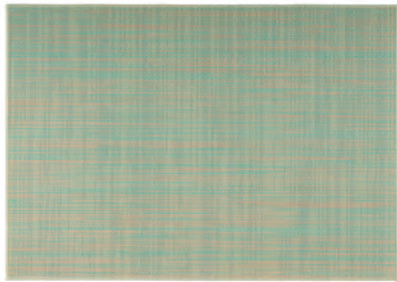

60506 - beige, turquoise

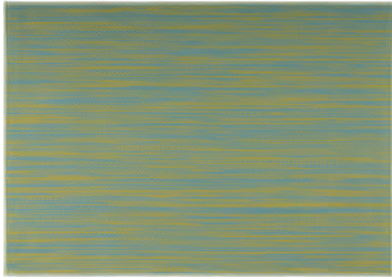

60507 - yellow, light blue



60508 - light blue, dark blue

Tischset Feinband „TAO“

placemat fine band  
mantelín cinta fina  
set de table, tressage fin



	cm		VE / unit
60506	45 x 33	beige, türkis / beige, turquoise	6
60507	45 x 33	gelb, hellblau / yellow, light blue	6
60508	45 x 33	hellblau, dunkelblau / light blue, dark blue	6



60506 - beige, turquoise



60507 - yellow, light blue

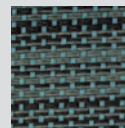

60508 - light blue, dark blue



60510 - LINES orange red



60511 - LINES orange, yellow

Tischset Feinband

placemat fine band  
mantelín cinta fina  
set de table, tressage fin



	cm		VE / unit
60510	45 x 33	LINES orange, rot / LINES orange red	6
60511	45 x 33	LINES orange, gelb / LINES orange yellow	6
60531	45 x 33	LINES schwarz / LINES black	6
60532	45 x 33	LINES pastell / LINES pastell	6
60533	45 x 33	LINES bordeaux / LINES bordeaux	6
60534	45 x 33	LINES rot / LINES red	6
60530	45 x 33	STRIPES grau / STRIPES grey	6
60540	45 x 33	FRAMES grau / FRAMES grey	6
60541	45 x 33	FRAMES schwarz / FRAMES black	6



60510 - LINES orange red



60511 - LINES orange, yellow

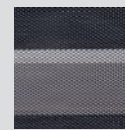

60531 - LINES black

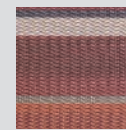

60532 - LINES pastell

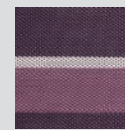

60533 - LINES bordeaux

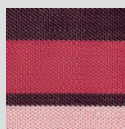

60534 - LINES red

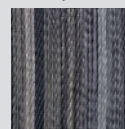

60530 - LINES grey

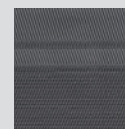

60540 - FRAMES grey

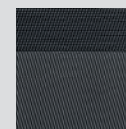

60541 - FRAMES black



## TABLE SET

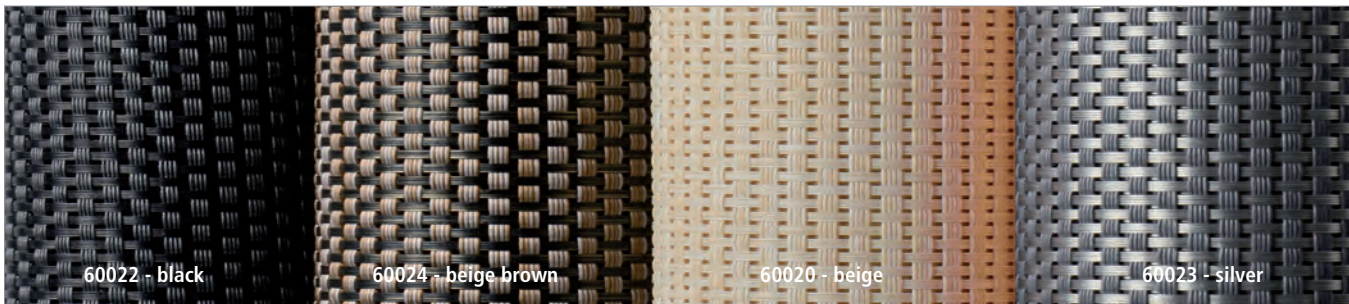

60022 - black

60024 - beige brown

60020 - beige

60023 - silver

### Schmalband Tischläufer

table runner fine fabric  
camino de mesa  
chemin de table

pflegeleichtes Kunststoffgeflecht

easy to clean

fácil de limpiar

nettoyage aisé



	cm	
60022	45 x 150	schwarz / black
60024	45 x 150	beige, braun / beige, brown
60020	45 x 150	beige / beige
60023	45 x 150	silbergrau / silver grey



60551

### Servietten- und Bestecktaschen, 6er Set

cutlery bag, 6 pcs. set  
bolsa cubiertos, set de 6  
pochette couverts, set de 6



	cm		pcs.
60551	24 x 9	silbergrau / silvergrey	6
60550	24 x 9	beige / beige	6
60552	24 x 9	beige braun / beige brown	6
60554	24 x 9	platin / platinum	6



60550 - beige

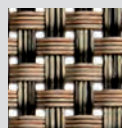

60552 - beige/braun

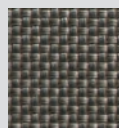

60554 - platin

# ENAMELWARE



## Teller „ENAMELWARE“

plate  
plato  
assiette



	Ø cm	↑ cm	Farbe / Colour	
40664	20	2		flacher Teller
40665	24	2		flacher Teller
40666	26	2		flacher Teller



## Teller „ENAMELWARE“

plate  
plato  
assiette



	Ø cm	↑ cm	ltr.	Farbe / Colour	
40661	18	3,5	0,35		tiefer Teller
40662	22	3,5	0,60		tiefer Teller
40663	24	3,5	0,85		tiefer Teller



## Schale „ENAMELWARE“

bowl  
cuenco  
bol



	cm	↑ cm	ltr.	Farbe / Colour
40667	16 x 12,0	3,5	0,20	
40668	18 x 13,5	4,0	0,35	



## Schale „ENAMELWARE“

bowl  
cuenco  
bol



	cm	↑ cm	ltr.	Farbe / Colour
40669	28 x 23	4,5	1,9	

## ENAMELWARE



### Henkelbecher „ENAMELWARE“

beaker  
vaso coctelero  
bol mélangeur



	Ø cm	↑ cm	ltr.	Farbe / Colour
40636	7	5	0,10	White/Blue
40632	9	8	0,35	White/Blue
40637	10	9	0,50	White/Blue



### Henkelbecher „ENAMELWARE“

beaker  
vaso coctelero  
bol mélangeur



	Ø cm	↑ cm	ltr.	Farbe / Colour
40633	9	8	0,35	Red/Black



### Henkelbecher „ENAMELWARE“

beaker  
vaso coctelero  
bol mélangeur



	Ø cm	↑ cm	ltr.	Farbe / Colour
40634	9	8	0,35	Green/Black



### Henkelbecher „ENAMELWARE“

beaker  
vaso coctelero  
bol mélangeur



	Ø cm	↑ cm	ltr.	Farbe / Colour
40635	9	8	0,35	Blue/Black



### Schale „ENAMELWARE“

bowl  
cuenco  
bol



	Ø cm	↑ cm	ltr.	Farbe / Colour
40645	7,0	4,5	0,08	White/Blue
40646	8,0	3,5	0,08	White/Blue
40638	13,0	6,0	0,50	White/Blue
40647	16,5	4,5	0,45	White/Blue



# Original Weck



## Weck-Flaschen, 6er Set

Weck-bottles, 6 pcs.  
Weck-botellas, set de 6  
Weck-bouteilles, set de 6



6 Flaschen + 6 Deckel, ideal zum Servieren von Saft, Smoothie, Dressing und Saucen  
6 bottles + 6 covers, ideal for serving juice, smoothie, dressing and sauces  
6 botellas + 6 tapas, ideal para servir zumo, licuado, aliño y salsas  
6 bouteilles + 6 couvercles, idéal pour servir de jus, smoothie, vinaigrette et sauces

	Ø cm	↑ cm	ltr.	pcs
82307	6	14,5	0,25	6



## Weck-Flaschen, 6er Set

Weck-bottles, 6 pcs.  
Weck-botellas, set de 6  
Weck-bouteilles, set de 6



6 Flaschen + 6 Deckel, ideal zum Servieren von Saft, Smoothie, Dressing und Saucen  
6 bottles + 6 covers, ideal for serving juice, smoothie, dressing and sauces  
6 botellas + 6 tapas, ideal para servir zumo, licuado, aliño y salsas  
6 bouteilles + 6 couvercles, idéal pour servir de jus, smoothie, vinaigrette et sauces

	Ø cm	↑ cm	ltr.	pcs
82308	6	19	0,5	6



## Weck-Flaschen, 6er Set

Weck-bottles, 6 pcs.  
Weck-botellas, set de 6  
Weck-bouteilles, set de 6



6 Flaschen + 6 Deckel, ideal zum Servieren von Saft, Smoothie, Dressing und Saucen  
6 bottles + 6 covers, ideal for serving juice, smoothie, dressing and sauces  
6 botellas + 6 tapas, ideal para servir zumo, licuado, aliño y salsas  
6 bouteilles + 6 couvercles, idéal pour servir de jus, smoothie, vinaigrette et sauces

	Ø cm	↑ cm	ltr.	pcs
82309	6	25,5	1,0	6



## GLASSES



### Weck-Gläser mit Deckel, 12er Set

Weck-glasses with lid, 12 pcs.  
Weck tarros de vidrio con tapa, set de 12  
Weck verrines avec couvercle, set de 12



#### 12 Gläser + 12 Deckel

12 glasses + 12 covers  
12 vasos + 12 tapas  
12 verrines + 12 couvercles

	Ø cm	↑ cm	ltr.	pcs
82316	7	8,0	0,22	12



### Weck-Gläser mit Deckel, 12er Set

Weck-glasses with lid, 12 pcs.  
Weck tarros de vidrio con tapa, set de 12  
Weck pots en verre avec couvercle, set de 12



#### 12 Gläser + 12 Deckel

12 glasses + 12 cover  
12 vasos + 12 tapas  
12 verrines + 12 couvercles

	Ø cm	↑ cm	ltr.	pcs
82345	9	6	0,20	12



### Weck-Gläser mit Deckel, 3er Set

Weck-glasses with lid, 3 pcs.  
Weck tarros de vidrio con tapa, set de 3  
Weck verrines avec couvercle, set de 3



#### 3 Gläser + 3 Deckel

3 glasses + 3 covers  
3 vasos + 3 tapas  
3 verrines + 3 couvercles

	Ø cm	↑ cm	ltr.	pcs
82346	11	7,5	0,37	3



### Weck-Gläser mit Deckel, 2er Set

Weck-glasses with lid, 2 pcs.  
Weck tarros de vidrio con tapa, set de 2  
Weck verrines avec couvercle, set de 2



#### 2 Gläser + 2 Deckel

2 glasses + 2 covers  
2 vasos + 2 tapas  
2 verrines + 2 couvercles

	Ø cm	↑ cm	ltr.	pcs
82347	11	11	0,58	2



12er Set ohne Deckel  
12 pcs. set without cover

### Gourmetgläser, 12er Set

gourmet glasses, 12 pcs.  
tarros gourmet, set de 12  
verres gourmet, set de 12



	Ø cm	↑ cm	ltr.	pcs
82359	5	3,5	0,035	12
82370	6	5,5	0,08	12
82371	6	8,0	0,16	12



### Weck-Gläser mit Deckel, 12er Set

Weck-glasses with lid, 12 pcs.  
Weck tarros de vidrio con tapa, set de 12  
Weck verrines avec couvercle, set de 12



#### 12 Gläser + 12 Deckel

12 glasses + 12 covers  
12 tarros + 12 tapas  
12 verrines + 12 couvercles

	Ø cm	↑ cm	ltr.	pcs
82350	5,5	6	0,075	12



### Weck-Gläser mit Deckel, 12er Set

Weck-glasses with lid, 12 pcs.  
Weck tarros de vidrio con tapa, set de 12  
Weck verrines avec couvercle, set de 12



#### 12 Gläser + 12 Deckel

12 glasses + 12 covers  
12 tarros + 12 tapas  
12 verrines + 12 couvercles

	Ø cm	↑ cm	ltr.	pcs
82351	5,5	9	0,145	12

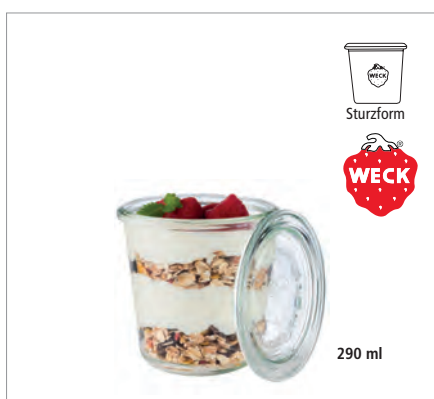

### Weck-Gläser mit Deckel, 6er Set

Weck-glasses with lid, 6 pcs.  
Weck tarros de vidrio con tapa, set de 6  
Weck verrines avec couvercle, set de 6



#### 6 Gläser + 6 Deckel

6 glasses + 6 covers  
6 tarros + 6 tapas  
6 verrines + 6 couvercles

	Ø cm	↑ cm	ltr.	pcs
82352	9	9	0,29	6



### Weck-Gläser mit Deckel, 6er Set

Weck-glasses with lid, 6 pcs.  
Weck tarros de vidrio con tapa, set de 6  
Weck verrines avec couvercle, set de 6



#### 6 Gläser + 6 Deckel

6 glasses + 6 covers  
6 tarros + 6 tapas  
6 verrines + 6 couvercles

	Ø cm	↑ cm	ltr.	pcs
82354	11	9	0,58	6



# Original WECK



370 ml



370 ml



580 ml



580 ml



Sturzform



370 ml

## Weck-Gläser mit Deckel, 2er Set

Weck-glasses with lid, 2 pcs.  
Weck tarros de vidrio con tapa, set de 2  
Weck verrines avec couvercle, set de 2

2 Gläser + 2 Edelstahl Deckel  
2 glasses + 2 stainless steel lids  
2 tarros + 2 tapas de acero inoxidable  
2 verrines + 2 couvercles en acier inox



	Ø cm	↑ cm	ltr.	pcs
82239	11	7,5	0,37	2



Sturzform



580 ml

## Weck-Gläser mit Deckel, 2er Set

Weck-glasses with lid, 2 pcs.  
Weck tarros de vidrio con tapa, set de 2  
Weck verrines avec couvercle, set de 2

2 Gläser + 2 Edelstahl Deckel  
2 glasses + 2 stainless steel lids  
2 tarros + 2 tapas de acero inoxidable  
2 verrines + 2 couvercles en acier inox



	Ø cm	↑ cm	ltr.	pcs
82240	11	11	0,58	2

klappbar  
foldable



370 ml

## Weck-Gläser mit Deckel, 2er Set

Weck-glasses with lid, 2 pcs.  
Weck tarros de vidrio con tapa, set de 2  
Weck verrines avec couvercle, set de 2

2 Gläser + 2 Edelstahl Deckel  
2 glasses + 2 stainless steel lids  
2 tarros + 2 tapas de acero inoxidable  
2 verrines + 2 couvercles en acier inox



	Ø cm	↑ cm	ltr.	pcs
82241	11	7,5	0,37	2

klappbar  
foldable



580 ml

## Weck-Gläser mit Deckel, 2er Set

Weck-glasses with lid, 2 pcs.  
Weck tarros de vidrio con tapa, set de 2  
Weck verrines avec couvercle, set de 2

2 Gläser + 2 Edelstahl Deckel  
2 glasses + 2 stainless steel lids  
2 tarros + 2 tapas de acero inoxidable  
2 verrines + 2 couvercles en acier inox



	Ø cm	↑ cm	ltr.	pcs
82242	11	11	0,58	2





**Weck-Gläser mit Deckel, 2er Set**

Weck-glasses with lid, 2 pcs.  
Weck tarros de vidrio con tapa, set de 2  
Weck verrines avec couvercle, set de 2



2 Gläser + 2 Holz Deckel  
2 glasses + 2 wooden lids  
2 tarros + 2 tapas de madera  
2 verrines + 2 couvercles en bois

	Ø cm	↑ cm	ltr.	pcs
82243	11	7,5	0,37	2



**Weck-Gläser mit Deckel, 2er Set**

Weck-glasses with lid, 2 pcs.  
Weck tarros de vidrio con tapa, set de 2  
Weck verrines avec couvercle, set de 2



2 Gläser + 2 Holz Deckel  
2 glasses + 2 wooden lids  
2 tarros + 2 tapas de madera  
2 verrines + 2 couvercles en bois

	Ø cm	↑ cm	ltr.	pcs
82244	11	11	0,58	2

**Deckel für Weck-Gläser / lids for Weck-glasses**

	Ø cm	↑ cm	fits to
82362	11	2	82243, 82244, 82346, 82347
82360	10,5	2	82239, 82240, 82346, 82347
82361	10,5	4,5	82241, 82242, 82346, 82347





## GLASSES



passende Gläser  
matching glasses  
82310  
82312  
82314

### Serviergestell „WECK“

serving stand  
expositor  
présentoir

ohne Gläser  
without glasses  
sin vasos  
sans verrines



	Ø cm	↑ cm	
33247	22	33	6 x Ø 6 cm



passende Gläser  
matching glasses  
82310  
82312  
82314

### Serviergestell „WECK“

serving stand  
expositor  
présentoir

ohne Gläser  
without glasses  
sin vasos  
sans verrines



	Ø cm	↑ cm	
33246	22	59	12 x Ø 6 cm



### Weck-Gläser mit Deckel, 12er Set

Weck-glasses with lid, 12 pcs.  
Weck tarros de vidrio con tapa, set de 12  
Weck verrines avec couvercle, set de 12



12 Gläser + 12 Deckel  
12 glasses + 12 covers  
12 vasos + 12 tapas  
12 verrines + 12 couvercles

	Ø cm	↑ cm	ltr.	pcs
82310	6	5,5	0,08	12
82312	6	7,0	0,14	12
82314	6	8,0	0,16	12

**Weck-Frischhaltecover, 5er Set**

airtight cover, 5 pcs.  
tapa hermética, set de 5  
couvercle hermétique, set de 5



für Rundrandgläser Ø 6 cm, 5er Set

for Ø 6 cm glasses, 5 pcs. set  
para vasos Ø 6 cm, set de 5  
pour verrines Ø 6 cm, set de 5

	Ø cm	pcs.
82338	7	5

**Gummidichtringe, 10er Set**

rubber washer, 10 pcs.  
juntas de goma, set de 10  
joints de caoutchouc, set de 10

für Deckel der Weck-Gläser, im Beutel verpackt

for covers of Weck-glasses  
para las tapas de los tarritos Weck  
pour la fermeture des verrines Weck

	fits to	pcs.
82318	82307, 82308, 82309, 82310, 82312, 82314, 82316	10
82394	82345	10
82395	82346, 82347	10

**8er Set Deckel-Klammer für 4 Weck-Gläser**

8 pcs. cover clamps for 4 Weck-glasses  
8 abrazaderas para 4 vasitos Weck  
8 agrafes pour 4 verrines Weck



	pcs.
82319	8



Topf darf nicht erhitzt werden!  
Topf ist nicht zum Kochen geeignet!

**Muscheltopf**

mussel pot  
mejillonera  
casserole à moules

schwarz emailliertes Stahlblech, mit Edelstahlrand

black enamelled steel, stainless steel rim

hierro esmaltado negro, borde inox

acier émaillé noir, bord inox



	Ø cm	↑ cm	Topf / pot ltr.	Deckel / lid ltr.
00623	13,5	9,0	0,75	0,60
00625	18,0	12,0	2,60	1,40
00626	20,0	13,0	3,30	1,60
00627	24,0	13,5	5,20	2,70



# ACACIA



## Servier- und Tortenplatte „ACACIA MINI“

cake stand  
porta pasteles  
présentoir à gâteaux

Akazienholz geölt  
acacia wood oiled  
madera de acacia aceitada  
bois d'acacia huilé

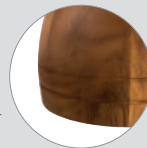

	Ø cm	↑ cm
33290	9,5	7
33291	13,0	9



## Servier- und Tortenplatte „ACACIA“

cake stand  
porta pasteles  
présentoir à gâteaux

Akazienholz geölt, mit möbelschonender Unterseite  
acacia wood oiled, with non-scratching undersurface  
madera de acacia aceitada, con base anti rayaduras  
bois d'acacia huilé, avec revêtement antirayures



	Ø cm	↑ cm
33292	24,0	8
33293	24,0	16
33294	33,0	8
33295	33,0	16
33296	38,5	8
33297	38,5	16

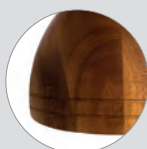

## Frischhalte- Haube / cover / campana / cloche



	Ø cm	↑ cm	fits to
06519	21	17	33292, 33293
06520	30	22	33294, 33295
06521	36	27	33296, 33297



**Torten- / Konditorplatte „SLATE“**

cake stand  
soporte para pastel  
présentoir à gâteaux

Rand fixiert die Haube, mit Antirutsch-Füßchen  
carved edge fixes the cover, with non-slip feet  
ranura para fijar bien la campana, con pies antideslizantes  
bord rainuré pour maintenir ferme la cloche, avec pieds antidérapants



	Ø cm	↑ cm	fits to
85046	21,5	2,5	06519
85047	30,5	3,5	06520, 06512
85048	37,5	4,0	06521



**Torten- / Konditorplatte „LOOPS“**

cake stand  
soporte para pastel  
présentoir à gâteaux

	Ø cm	↑ cm	fits to
85033	21,5	2,5	06519
85034	30,5	3,5	06520, 06512, 06510
85035	37,5	4,0	06521



**Torten- / Konditorplatte**

cake stand  
soporte para pastel  
présentoir à gâteaux

Rand fixiert die Haube, mit Antirutsch-Füßchen  
carved edge fixes the cover, with non-slip feet  
ranura para fijar bien la campana, con pies antideslizantes  
bord rainuré pour maintenir ferme la cloche, avec pieds antidérapants



	Ø cm	↑ cm	Farbe / Colour
00468	31,0	3,5	White
00469	31,0	3,5	Black



**Servier- und Tortenplatte „CASUAL“**

cake plate  
porta pasteles  
présentoir à gâteaux

	Ø cm	↑ cm
83890	31	8
83891	31	16



**Konditorplatte**

cake stand  
soporte para pastel  
présentoir à gâteaux

matt poliert / satin polished finish / acabado efecto satinado / poli mat effet satin



	Ø cm	↑ cm
00046	31	3



## CAKE STAND



NEW

00818

mit Rille / with groove

06512

### Servier- und Tortenplatte

cake stand  
porta pasteles  
présentoir à gâteaux

Eichenholz geölt, mit Antirutsch-Füßchen  
oak wood oiled with non-slip feet  
madera de roble aceitada, con pies antideslizantes  
bois de chêne huilé, avec pieds antidérapants



Ø cm      ↑ cm

00818      32      2,0



Präsentationsmöglichkeit  
presentation example



Ø 30,5 cm

85051

9 cm

Ø 30,5 cm

85052

17,0 cm

### Servier- und Tortenplatte „CLASSIC“

cake stand  
porta pasteles  
présentoir à gâteaux

Rand fixiert die Haube  
carved edge fixes the cover  
ranura para fijar bien la campana  
bord rainuré pour maintenir ferme la cloche



Ø cm      ↑ cm

85051      30,5      9

85052      30,5      17



### Servier- / Tortenplatte

cake stand  
soporte para pastel  
présentoir à gâteaux

matt poliert, drehbar, möbelschonende Moosgummi-Unterseite  
satin polished finish, rotating, foam rubber below to save your furniture  
acabado pulido satinado, giratorio, base revestida de goma para no rallar el mobiliario  
poli satiné, plateau tournant, revêtement mousse sous le pied pour ne pas rayer les meubles



Ø cm      ↑ cm

00463      30,5      9

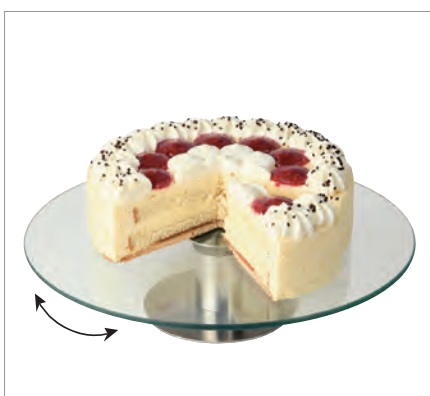

### Servier- / Tortenplatte

cake stand  
soporte para pastel  
présentoir à gâteaux

Fuß matt poliert, drehbar, möbelschonende Moosgummi-Unterseite  
foot satin polished finish, rotating, foam rubber below to save your furniture  
vidrio, pie inox satinado giratorio, base de goma para proteger el mobiliario  
plateau en verre, pied tournant inox poli satin, revêtement mousse sous le pied anti-rayures



Ø cm      ↑ cm

00444      30      7



**Sauciere**  
gravy boat  
salsera  
saucière



hochglanzpoliert, extra schwere Qualität  
mirror polished finish, high quality  
acabado efecto espejo, alta calidad, base pesada  
poli brillant, belle qualité, pied pesant

	cm	↑ cm	ltr.
40208	13 x 6,0	9,0	0,075
40204	16 x 7,5	9,0	0,125
40205	19 x 9,0	13,0	0,25
40206	22 x 10,5	13,5	0,4



**Sauciere**  
gravy boat  
salsera  
saucière



poliert / polished / pulido / poli

	cm	↑ cm	ltr.
40200	18,0 x 7,5	7,0	0,10
40203	21,5 x 9,5	8,5	0,15
40201	23,5 x 10,0	10,0	0,20
40202	23,5 x 12,0	12,0	0,45



**Thermo-Sauciere**  
insulated sauce boat  
salsera isotérmica  
saucière thermique



doppelwandig, Klappdeckelverschluss, Einhandbedienung  
double wall, hinged cover, one-hand operation  
doble pared, tapa con bisagra, se maneja con 1 mano  
double paroi, couvercle avec charnière, usage 1 main

	cm	↑ cm	ltr.
40207	19 x 12,5	13	0,4

## PLATE TRAYS



### Glocke

cloche / dome cover  
campana esférica  
cloche demi-sphère



außen hochglanzpoliert, innen matt poliert, mit verchromten Griff  
outside mirror polished finish, inside satin polished finish, with chromeplated handle  
exterior pulido acabado efecto espejo, interior pulido acabado efecto satinado, pomo cromado  
extérieur poli brillant, intérieur poli satin, buton chromé

	Ø cm	↑ cm
35734	29	18



### Platzteller

plate tray  
bajo plato  
assiette de présentation



hochglanzpoliert, Rand ingerollt  
mirror polished finish, rolled edge  
pulido efecto espejo, borde redondeado  
poli miroir, bord rond

	Ø cm
35735	31



### Platzteller

plate tray  
bajo plato  
assiette de présentation



hochglanzpoliert, mit Fadendekor  
mirror polished finish, with line edge  
pulido efecto espejo, con un filo en relieve  
poli miroir, filet relief

	Ø cm
35730	30,5
36233	33,0



### Platzteller

plate tray  
bajo plato  
assiette de présentation



hochglanzpoliert, mit Perlrand  
mirror polished finish, with pearl edge  
acabado pulido efecto espejo, con borde aperlado  
poli miroir, bord perlé

	Ø cm
35720	30,5
36323	33,0



### Tischkrümelentferner

crumber  
recogemigas  
ramasse-miettes



matt poliert / satin polished finish / acabado mate, fácil de usar, mango hueco  
mat satiné, manche creux, simple à utiliser

	Ø cm	↑ cm	
00058	6,5 x 2,5	22	Hohlgriff / hollow handles
00581	19,0 x 4,5	1	geschliffene Edelstahlkante flat grinded stainless steel edge



### Untersetzer, 6er Set

coaster, 6 pcs.  
posavasos, set de 6  
plateau sous-verre, set de 6



hochglanzpoliert, schwere Ausführung, Rand eingerollt  
mirror polished finish, heavy quality, rolled edge  
acabado pulido efecto espejo, alta calidad, borde redondeado  
effet miroir, bord rond, qualité extra

	Ø cm	pcs.
35711	10	6
35912	12	6



### Serviettenringe, 4er Set

napkin rings, 4 pcs.  
servilleteros, set de 4  
anneaux porte-serviette, set de 4



	Ø cm	↑ cm	pcs.
04446	4,5	2,5	4



### Rechnungstablett

bill presenter  
porta cuenta  
porte-addition



mit Klemme für Rechnung  
with clip for bill  
con clip para la nota  
avec clip pour la note

	cm	↑ cm	Material / material
30108	20 x 12	0,5	ABS Kunststoff / ABS plastic
30110	17 x 11	1,0	Edelstahl / stainless steel



## TABLE CUTLERY BIN



### Besteckkorb „ECONOMIC“

cutlery dispenser  
dispensador de cubiertos  
corbeille à couverts



in Handarbeit geflochten

wickerwork  
trensado a mano  
tressage à main

	Ø cm	↑ cm	Farbe / Colour
40130	12	15	
40007	12	15	
40012	12	15	
40013	12	15	



### Besteckkorb „ECONOMIC“

cutlery dispenser  
dispensador de cubiertos  
corbeille à couverts



in Handarbeit geflochten

wickerwork  
trensado a mano  
tressage à main

	cm	↑ cm	Farbe / Colour
40131	27 x 10	4,5	
40009	27 x 10	4,5	
40010	27 x 10	4,5	
40011	27 x 10	4,5	



### Table Caddy „COUNTRY STYLE“

table barrel  
caddy de mesa  
caddy de table



cooler Country-Style, nicht für den direkten Kontakt mit Lebensmitteln verwendbar

condiment and cutlery holders or even for food presentation, the mini barrels should not come into contact with food, they should be lined with our greaseproof paper

estilo campo, no aptos para el contacto directo con alimentos, sólo usando papel alimenticio

de style champêtre, pas de contact direct avec aliments, seulement en utilisant papier alimentaire

	Ø cm	↑ cm
11930	17,5	8,5
11931	11,5	14,0



**Tischreste- / Besteckbehälter „TOP CHROME“**

table waste bin / cutlery bin  
 papelera de sobremesa / recipiente para cubiertos  
 poubelle de table / récipients pour couverts



mit verchromten Rand  
 with chrome plated ring  
 con anillo cromado  
 avec bord chromé

	Ø cm	↑ cm	ltr.	Farbe / Colour
00025	13	15	1	
00026	13	15	1	



**Tischreste- / Besteckbehälter „BASE CHROME“**

table waste bin / cutlery bin  
 papelera de sobremesa / recipiente para cubiertos  
 poubelle de table / récipients pour couverts



mit verchromten Boden  
 with chrome bottom  
 con base cromada  
 avec base chromée

	Ø cm	↑ cm	ltr.	Farbe / Colour
00019	13	15	1,3	
00020	13	15	1,3	



**Besteckköcher**

cutlery basket  
 cesta para cubiertos  
 corbeille à couverts



	Ø cm	↑ cm	
11998	9,7	13,7	Kunststoff weiß / white plastic plástico blanco / plastique blanc
11999	9,7	13,7	matt poliert / satin polished finish acero inoxidable / inox

11998  
Köcher weiß

11999  
Köcher Edelstahl



**Tischreste- / Besteckbehälter**

table garbage bin / cutlery bin  
 papelera de sobremesa / recipiente para cubiertos  
 poubelle de table / récipients pour couverts



matt poliert, mit abnehmbaren Lochdeckel  
 satin polished finish, with removeable cover  
 acabado pulido satinado, con tapa desmontable  
 poli mat satiné, avec couvercle démontable ouvert au centre

	Ø cm	↑ cm	ltr.
00028	10	12	0,7



**Tischrestebehälter**

table garbage bin  
papelera de sobremesa  
poubelle de table



**matt poliert, abnehmbarer Schwingdeckel, mit Bajonettverschluss „fester Deckelsitz“**  
satin polished finish, swing cover, cover removable  
acabado satinado, tapa basculante desmontable  
poli mat satiné, couvercle basculant démontable

	Ø cm	↑ cm	ltr.
00029	12	17	1,2
00027	10	13	0,7



**Tischrestebehälter**

table garbage bin  
papelera de sobremesa  
poubelle de table



**Behälter aus weiß lackiertem Metall, Edelstahl-Lochdeckel**  
metall white, stainless cover with hole  
tapa, acero inoxidable, con apertura  
couvercle inox, avec ouverture centrale, récipient en acier laqué blanc

	Ø cm	↑ cm	ltr.
00292	12	15	1,2



**Tischreste- / Besteckbehälter**

table waste bin / cutlery bin  
papelera de sobremesa / recipiente para cubiertos  
poubelle de table / récipients pour couverts



**mit verchromten Rand, inkl. herausnehmbarem Einteiler (4 Fächer)**  
with chrome plated ring, incl. divider (4 chambers)  
con anillo cromado  
avec bord chromé

	cm	↑ cm	Farbe / Colour
00016	14 x 14	16	■



**Tischrestebehälter „SUNDAY“**

table waste bin  
papelera de sobremesa  
poubelle de table



**matt poliert, inkl. Deckel, fester Deckelsitz**  
satin polished finish, incl. cover, cover removeable  
acero inoxidable mate, con tapa  
inox mat, avec couvercle

	Ø cm	↑ cm	ltr.
00024	10	18	1,1



**Besteckbehälter „TIN“**

cutlery bin  
recipiente  
récipient



Behälter aus Metall mit Tragegriff aus Holz  
container made of metal with wooden handle  
contenedor de metal con asa de madera  
conteneur métallique avec poignée en bois

	cm	↑ cm
00014	24,5 x 12	18,5



**Besteckköcher**

cutlery basket  
cesta para cubiertos  
corbeille à couverts



	cm	↑ cm	Farbe / Colour
84535	12 x 12	16	White
84536	12 x 12	16	Black



Abtropflöcher  
drainer holes



**Besteckständer**

cutlery basket  
porta cubiertos  
porte-couverts



Behälter aus Edelstahl, matt poliert  
container made of stainless steel, matt polished  
contenedor de acero inoxidable, pulido mate  
conteneur en acier inox, poli mat

	Ø cm	↑ cm
11921	10	10,0
11922	12	13,5



## TABLE GARBAGE BIN



**Tischrestebehälter**  
table garbage bin  
papelera de sobremesa  
poubelle de table



	Ø cm	↑ cm	ltr.	Farbe / Colour
02038	11	14	0,9	White
02039	11	14	0,9	Black



**Tischrestebehälter**  
table garbage bin  
papelera de sobremesa  
poubelle de table



	Ø cm	↑ cm	ltr.
00311	14	15	1,2



**Tischrestebehälter**  
table garbage bin  
papelera de sobremesa  
poubelle de table



**Kunststoff weiß / granit, abnehmbarer Schwingdeckel**  
white plastic, swing cover, cover removable  
plástico blanco/granito, tapa basculante desmontable  
plastique blanc/gris chiné, couvercle basculant démontable

	Ø cm	↑ cm	ltr.
00031	12	18	1,4



**Tischrestebehälter „INTERNATIONAL“**  
table waste bin  
papelera de sobremesa  
poubelle de table



**Deckel-Ring mit Dichtung, internationale Beschriftung**  
cover with sealing ring, internationale Beschriftung  
tapa con junta, texto multi-idomas  
couvercle avec joint, texte multilingue

	Ø cm	↑ cm	ltr.
83847	10	17,5	1



**Tischrestebehälter**  
table garbage bin  
papelera de sobremesa  
poubelle de table



	Ø cm	↑ cm	ltr.
83999	13 / 9	14	1,2



**Besteckbehälter „ELEMENT“**

cutlery bin  
 recipiente para cubiertos  
 récipients pour couverts



mit Abflussloch, mit weißem Logo, Bodeneinlage aus Silikon zum Schonen des Bestecks, mit möbelschonender Unterseite  
 with drain hole, with white logo, silicone floor inserts for saving the cutlery, with non-scratching undersurface  
 con orificio de drenaje, con logotipo blanco, base de silicona para proteger la cubertería, con base anti rayaduras  
 avec trou de drainage, avec logo blanc, insert de silicone pour protéger la coutellerie, avec revêtement antirayures

	Ø cm	↑ cm	Logo
11935	12	14	fork
11936	12	14	knife
11937	12	14	spoon



**Besteckbehälter „ELEMENT“**

cutlery bin  
 recipiente para cubiertos  
 récipients pour couverts



mit Abflussloch, mit Besteck Logo, Bodeneinlagen aus Silikon zum Schonen des Bestecks, mit möbelschonender Unterseite  
 with drain hole, with cutlery logo, silicone floor inserts for saving the points of knives, with non-scratching undersurface  
 con orificio de drenaje, con logotipo de cubertería, soporte de silicona para proteger las puntas de los cuchillos, con base antirrayaduras  
 avec le trou de drainage, avec le logo de coutellerie, insert de silicone pour protéger les pointes des couteaux, avec base revêtu antirayures

	Ø cm	↑ cm
00018	11	14



**Besteckbehälter „ACACIA“**

cutlery bin  
 recipiente para cubiertos  
 récipients pour couverts



Akazienholz natur  
 acacia wood nature  
 madera de acacia natural  
 bois d'acacia naturelle

	cm	↑ cm	Logo
11939	14 x 14	15	fork / knife / spoon

**NEW** **MENU HOLDER**

**zum Einschieben der Speisekarten – schneller Austausch jederzeit möglich!**  
for inserting the menus - quick exchange possible at any time!

Der Kartenhalter ist völlig unkompliziert zu handhaben, denn er verfügt über eine Vorrichtung, in die die Karten einfach eingeschoben und schnell ausgetauscht werden können.

The menu holder is completely uncomplicated to handle, because it has a device into which the cards can simply be inserted and quickly exchanged.

El uso del porta menús es totalmente sencillo, ya que dispone de un dispositivo en el que simplemente se introducen las tarjetas y se intercambian rápidamente.

L'utilisation du porte-cartes est très simple, car il dispose d'un dispositif dans lequel les cartes peuvent être simplement insérées et rapidement échangées.

**DIN A6**

71521

**Kartenhalter 2-teilig**  
menu holder, 2 pcs.  
porta menús, set de 2  
porte-cartes, set de 2

1 Fuß aus Edelstahl, 1 Menühalter aus Acryl  
1 stainless steel base, 1 menu holder made of acrylic  
1 base de acero inoxidable, porta menús acrílico  
1 base en acier inox, porte-cartes en acrylique

	cm	↑ cm		
71521	10,5 x 7	17	stainless steel	
71527	10,5 x 7	17	black	

**DIN A5**

71528

**Kartenhalter 2-teilig**  
menu holder, 2 pcs.  
porta menús, set de 2  
porte-cartes, set de 2

1 Fuß aus Edelstahl, 1 Menühalter aus Acryl  
1 stainless steel base, 1 menu holder made of acrylic  
1 base de acero inoxidable, porta menús acrílico  
1 base en acier inox, porte-cartes en acrylique

	cm	↑ cm		
71522	15 x 7	23	stainless steel	
71528	15 x 7	23	black	

**DIN A4**

71523

**Kartenhalter 2-teilig**  
menu holder, 2 pcs.  
porta menús, set de 2  
porte-cartes, set de 2

1 Fuß aus Edelstahl, 1 Menühalter aus Acryl  
1 stainless steel base, 1 menu holder made of acrylic  
1 base de acero inoxidable, porta menús acrílico  
1 base en acier inox, porte-cartes en acrylique

	cm	↑ cm		
71523	21 x 7	32	stainless steel	
71529	21 x 7	32	black	



**Mini Staffelei, 2 teilig**

easel mini, 2 pcs.  
caballete mini, set de 2  
chevale mini, set de 2

HOLZ  
WOOD

1 Ständer aus Akazienholz, 1 Schild kann senkrecht oder waagrecht verwendet werden  
1 acacia wood stand, 1 sign can be used vertically or horizontally  
1 soporte de madera de acacia, 1 el cartel se puede utilizar vertical u horizontalmente  
1 support en bois d'acacia, 1 le panneau peut être utilisé verticalement ou horizontalement

	cm	↑ cm
71520	13,5 x 10,0	19



waagrecht  
horizontal



senkrecht  
vertical

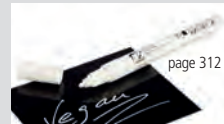

71490 Kreide-Marker  
chalk marker

Inhalt ohne Stift  
content without pen  
contenido sin bolígrafo  
contenu sans stylo



**Kartenhalter „ELEMENT“, 2 teilig**

menu holder, 2 pcs.  
soporte de tarjeta de menú, set de 2  
porte-cartes de menu, set de 2

BETON  
CONCRETE

ACRYL  
ACRYLIC

1 Fuß aus Beton, 1 Menühalter aus Acryl  
1 concrete base, 1 acrylic menu sign / holder  
1 base de hormigón, 1 letrero de menú acrílico  
1 socle en béton, 1 plaque de menu en acrylique

	cm	↑ cm
71496	11,5 x 4,5	10
71497	15,5 x 6,5	26



**Kartenhalter-Set**

card holder set  
portatarjetas, set  
porte-cartes, set

PP  
POLYPROPYLEN

METALL  
VERCHROMT

18-teilig: 6 Kartenhalter 4 x 2,5 cm + 12 Kunststoff-Beschriftungskarten 10 x 6 cm  
18 pcs. set: 6 card holder 4 x 2,5 cm + 12 plastic cards of inscription 10 x 6 cm  
set de 18: 6 soportes 4 x 2,5 cm + 12 tarjetas de plástico 10 x 6 cm  
set de 18: 6 supports 4 x 2,5 cm + 12 étiquettes en plastique 10 x 6 cm

	cm
00022	4 x 2,5

6 Stck. Halter  
12 Stck. Karten



## MENU HOLDER

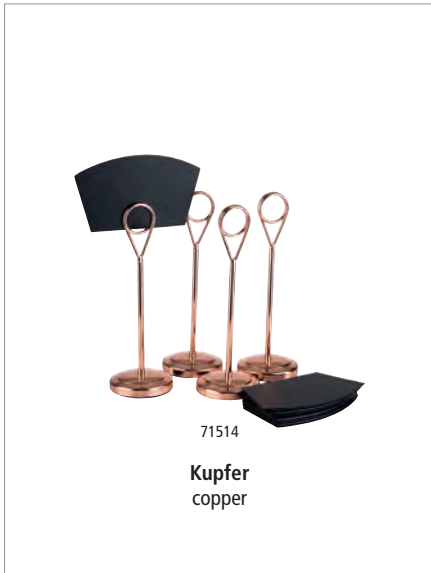

### Kartenhalter, 4er Set

table stands, 4 pcs.  
portatarjetas, set de 4  
porte-cartes, set de 4



hochglanzpoliert, inkl. 20 schwarze Beschriftungskarten aus Polypropylen  
mirror polished finish, incl. 20 black cards made of polypropylene  
pulido brillante, incl. 20 tarjetas negras de polipropileno  
poli miroir, incl. 20 étiquettes noires en polypropylène

	Ø cm	↑ cm	pcs.	Farbe / Colour	
71511	5	10,5	4		copper
71514	5	15,5	4		copper
71517	5	20,5	4		copper

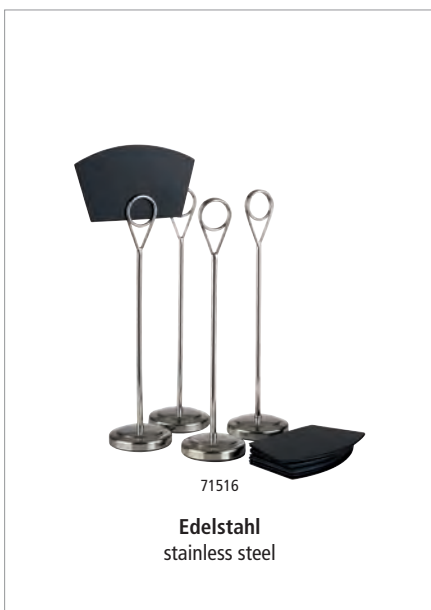

### Kartenhalter, 4er Set

table stands, 4 pcs.  
portatarjetas, set de 4  
porte-cartes, set de 4



hochglanzpoliert, inkl. 20 schwarze Beschriftungskarten aus Polypropylen  
mirror polished finish, incl. 20 black cards made of polypropylene  
pulido brillante, incl. 20 tarjetas negras de polipropileno  
poli miroir, incl. 20 étiquettes noires en polypropylène

	Ø cm	↑ cm	pcs.	Farbe / Colour	
71510	5	10,5	4		stainless steel
71513	5	15,5	4		stainless steel
71516	5	20,5	4		stainless steel

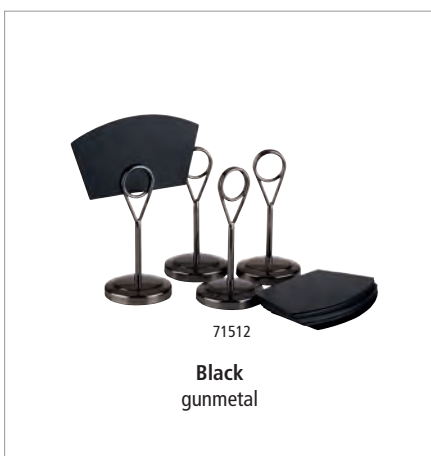

### Kartenhalter, 4er Set

table stands, 4 pcs.  
portatarjetas, set de 4  
porte-cartes, set de 4



hochglanzpoliert, inkl. 20 schwarze Beschriftungskarten aus Polypropylen  
mirror polished finish, incl. 20 black cards made of polypropylene  
pulido brillante, incl. 20 tarjetas negras de polipropileno  
poli miroir, incl. 20 étiquettes noires en polypropylène

	Ø cm	↑ cm	pcs.	Farbe / Colour	
71512	5	10,5	4		gunmetal
71515	5	15,5	4		gunmetal
71518	5	20,5	4		gunmetal



### Beschriftungskarten, 10er Set

designation cards, 10 pcs.  
tarjetas, set de 10  
étiquettes, set de 10



	cm	✱ mm
00037	7,5 x 5	0,4



**Bankettkartenständer**

menu stand / table number  
 porta-etiqueta o carta de sobremesa  
 porte-étiquette de table, porte-menu, ou n° de table



hochglanzpoliert, schwere Qualität  
 mirror polished finish, heavy gauge  
 acero inoxidable de alta calidad  
 inox, belle qualité

	Ø cm	↑ cm
71460	7,5	18,5
71461	7,5	29
71462	7,5	46



**Tischkartenhalter, 4er Set**

table stands, 4 pcs.  
 pinzas porta-etiquetas, set de 4  
 porte-étiquettes à pince, set de 4



hochglanzpoliert, schwerer Fuß, inkl. 20 weiße Beschriftungskarten  
 mirror polished finish, heavy foot, incl. 20 white labels  
 acabado brillante, incluye 20 etiquetas en blanco  
 poli brillant, inclut 20 étiquettes blanches

	Ø cm	↑ cm	pcs.
00070	4	10	4



**Tischaufsteller, 10er Set**

table stands, 10 pcs.  
 caballes de mesa, set de 10  
 chevalets de table, set de 10



Ecken abgerundet  
 corners rounded  
 esquinas redondeadas  
 coins arrondies

	cm	↑ cm	pcs.
00011	7,5 x 3,5	5	10
00012	10,5 x 6	6,5	10



**Kartenhalter, 2er Set**

card holder, 2 pcs.  
 soporte de mesa, set de 2  
 support de table, set de 2



inkl. 40 Beschriftungskarten, durch Magnete einfach zusammenklappbar  
 incl. 40 cards, easily foldable with magnets  
 incluye 40 tarjetas, fácil de plegar, con imanes  
 inclut 40 étiquettes, fácil à plier, avec aimants

	cm	↑ cm	pcs.
00076	9 x 3	5,5	2

## MENU HOLDER

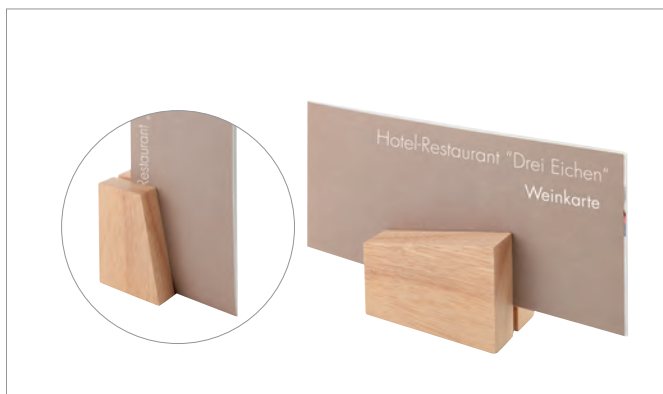

### Kartenhalter, 2er Set

menu holder, 2 pcs.  
porta cartas de mesa, set de 2  
supports pour menu de table, set de 2

HOLZ  
WOOD



	cm	↑ cm	pcs.
00023	8,5 x 6	4,5 / 8,5	2



### Kartenhalter, 2er Set

menu holder, 2 pcs.  
porta cartas de mesa, set de 2  
porte-menus de table, set de 2

EDELSTAHL  
STAINLESS  
INOX



**matt poliert**

satin polished finish  
pulido satinado  
poli mat satiné

	cm	↑ cm	pcs.
00021	8,5 x 4	4 / 8,5	2



### Tischkartenhalter

table stand  
soporte-carta para la mesa  
support pour menu de table

EDELSTAHL  
STAINLESS  
INOX



**matt poliert**

satin polished finish  
pulido satinado  
poli mat satiné

	cm	↑ cm	pcs.
00030	8 x 7,0	2	1
00036	6 x 4,5	4	1

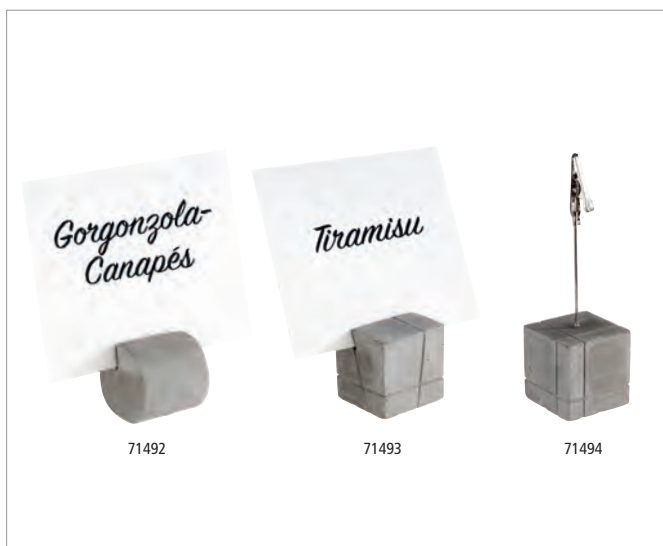

### Kartenhalter-Set, 4er Set

table stands, 4 pcs.  
portatarjetas, set de 4  
porte-cartes, set de 4

BETON  
CONCRETE



**inkl. 30 Beschriftungskarten (15 x weiß + 15 x schwarz)**

incl. 30 labels (15 x white + 15 x black)

incl. 30 tarjetas (15 x blanco + 15 x negro)

incl. 20 étiquettes (15 x blanc + 15 x noir)

	cm	↑ cm	pcs.
71492	3 x 3	3	4
71493	3 x 3	3	4
71494	3 x 3	12	4



**Kartenhalter, 4er Set**

table stands, 4 pcs.  
soportes de mesa, set de 4  
support de table, set de 4



**inkl. 20 weiÙe Beschriftungskarten ca. 10 x 8 cm**  
incl. 20 white labels 10 x 8 cm  
incluye 20 etiquetas blancas 10 x 8 cm  
20 étiquettes blanches incluses 10 x 8 cm

	cm	↑ cm	pcs.	Farbe / Colour
00074	3 x 3	12	4	

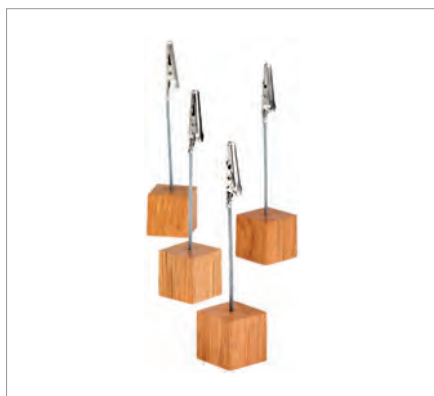

**Kartenhalter, 4er Set**

table stands, 4 pcs.  
soportes de mesa, set de 4  
support de table, set de 4



**inkl. 20 weiÙe Beschriftungskarten ca. 10 x 8 cm**  
incl. 20 white labels 10 x 8 cm  
incluye 20 etiquetas blancas 10 x 8 cm  
20 étiquettes blanches incluses 10 x 8 cm

	cm	↑ cm	pcs.	Farbe / Colour
00700	2,5 x 2,5	12	4	



**Kartenhalter „WÜRFEL“, 4er Set**

table stands, 4 pcs.  
soporte de mesa, set de 4  
porte-étiquettes, set de 4



**inkl. 20 weiÙe Beschriftungskarten ca. 10 x 8 cm, mehrfach beschriftbar**  
incl. 20 white labels 10 x 8 cm  
incluye 20 etiquetas blancas 10 x 8 cm  
20 étiquettes blanches incluses 10 x 8 cm

	cm	pcs.
00078	3 x 3 x 3	4



**Kartenhalter „ZYLINDER“, 4er Set**

table stands, 4 pcs.  
soporte de mesa, set de 4  
porte-étiquettes, set de 4



**inkl. 20 weiÙe Beschriftungskarten ca. 10 x 8 cm, mehrfach beschriftbar**  
incl. 20 white labels 10 x 8 cm  
incluye 20 etiquetas blancas 10 x 8 cm  
20 étiquettes blanches incluses 10 x 8 cm

	cm	pcs.
00079	3 x 3 x 3	4



**Tafelhalter / Schild**

slate sign  
caballete de mesa, pizarra  
plaque signalétique avec support



	cm	↑ cm
00060	12 x 4	7



## MENU HOLDER



### Kartenhalter, 2er Set

table stands, 2 pcs.  
portatarjetas, set de 2  
porte-cartes, set de 2

BETON  
CONCRETE



inkl. 30 Beschriftungskarten ca. 10 x 8 cm (15 x weiß + 15 x schwarz)  
incl. 30 labels 10 x 8 cm (15 x white + 15 x black)  
incl. 30 tarjetas 10 x 8 cm (15 x blanco + 15 x negro)  
incl. 20 étiquettes 10 x 8 cm (15 x blanc + 15 x noir)

	cm	↑ cm	pcs.
71495	8 x 3,5	6	2



### Kartenhalter, 2er Set „KLAMMER“

table stand, 2 pcs.  
soporte de mesa, set de 2  
support de table, set de 2

HOLZ  
WOOD



inkl. 30 Beschriftungskarten ca. 10 x 8 cm (15 x weiß, 15 x schwarz)  
incl. 30 cards 10 x 8 cm (15 x white, 15 x black)  
incluye 30 tarjetas 10 x 8 cm (15 x blanco, 15 x negro)  
includ 30 étiquettes 10 x 8 cm (15 x blanc, 15 x noir)

	cm	↑ cm	pcs.	Farbe / Colour
71487	4 x 2,5	10	2	■
71489	4 x 2,5	10	2	■

Beschriftungskarten, 50 Stück / designation cards, 50 pcs. set  
cartelitos de designación, 50 piezas / cartes de désignation, 50 pièces

	cm	pcs.	Farbe / Colour	fits to
71498	10 x 8	50	■	71487, 71489
71499	10 x 8	50	■	71487, 71489



### Tischkartenhalter „PROFI“

table stand  
soporte de mesa  
support de table

METALL  
VERCHROMT



	cm	↑ cm
40425	9,5 x 7,5	13,5



### Tischkartenhalter

table stand  
soporte de mesa  
support de table

EDELSTAHL  
STAINLESS  
INOX



mit möbelschonender Unterseite  
non-scratching undersurface  
con base antirrayaduras  
avec base revêtue antirayures

	cm	↑ cm
00071	14 x 5,5	14



**Schilderhalter „FLEXIBEL“**

sign holder  
soporte para cartelito  
support pour menu de table



biegsamer Draht mit zwei Klemmen, extrem flexibel, die Klemmen lassen sich weit öffnen  
bedable metal coil adds visual interest, two metal clip open  
metal cromado flexible, 2 pinzas con gran apertura  
métal chromé, flexible, 2 pinces à grande ouverture

	→ cm	
71470	12	ohne Schilder / without signs sin cartelitos / sans étiquette
71471	23	ohne Schilder / without signs sin cartelitos / sans étiquette
71480	12	inkl. 10 Schilder 11879 / incl. 10 signs 11879 con 10 cartelitos 11879 / avec 10 étiquettes 11879

Schilder, 10er Set / signs, 10 pcs. / set de 10 cartelitos / set de 10 étiquettes

	cm	
11879	7,7 x 5,2	
12879	5,0 x 3,0	



**10 Schilderhalter „FLEX CLIP“**

10 sign holders  
10 clips  
10 porte-étiquettes



Durch die bewegliche Verbindung der Klemme und Schilderhalterung ein extrem flexibler Cliphalter!  
multi angle ticket clip / inclinable con pinza / inclinable avec pince

	→ cm	Farbe / Colour
71472	9,5	White
71474	9,5	Black

Schilder, 10er Set / signs, 10 pcs. / set de 10 cartelitos / set de 10 étiquettes

	cm	pcs.
11879	7,7 x 5,2	10
12879	5,0 x 3,0	10



**10 Beschriftungsclips, inkl. 10 Schilder**

10 sign holders, with 10 signs  
10 soportes + 10 cartelitos  
10 supports + 10 étiquettes



	cm	Farbe / Colour
71482	6 x 2,7	White
71483	6 x 2,7	Black

Schilder, 10er Set / signs, 10 pcs. / set de 10 cartelitos / set de 10 étiquettes

	cm	
11879	7,7 x 5,2	
12879	5,0 x 3,0	



**Tischaufsteller 2er Set**

table stands, 2 pcs.  
caballetes de mesa, set de 2  
chevalets de table, set de 2



	cm	↑ cm	
00017	5,5 x 5	3,5	reserviert
00013	5,5 x 5	3,5	reserved
00572	5,5 x 5	3,5	smoking

## MENU HOLDER



71425

71427

### Kartenhalter, 4er Set

table stands, 4 pcs.  
portatarjetas, set de 4  
porte-cartes, set de 4



inkl. 30 Beschriftungskarten ca. 10 x 8 cm (15x weiß, 15x schwarz)

incl. 30 labels 10 x 8 cm (15x white + 15x black)

incl. 30 tarjetas 10 x 8 cm (15x blanco + 15x negro)

incl. 30 étiquettes 10 x 8 cm (15x blanc + 15x noir)

	Ø cm	↑ cm	Farbe / Colour	pcs.
71425	3	10	Marmor weiß / marble white	4
71427	3	10	Marmor grau / marble grey	4



71426

71428

### Kartenhalter, 4er Set

table stands, 4 pcs.  
portatarjetas, set de 4  
porte-cartes, set de 4



inkl. 30 Beschriftungskarten ca. 10 x 8 cm (15x weiß, 15x schwarz)

incl. 30 labels 10 x 8 cm (15x white + 15x black)

incl. 30 tarjetas 10 x 8 cm (15x blanco + 15x negro)

incl. 30 étiquettes 10 x 8 cm (15x blanc + 15x noir)

	cm	↑ cm	Farbe / Colour	pcs.
71426	3,5 x 3,5	10	Marmor weiß / marble white	4
71428	3,5 x 3,5	10	Marmor grau / marble grey	4



### Beschriftungsetiketten

labeling labels  
etiquetas  
étiquettes



12 Bögen mit je 6 Motiven, selbstklebend, mit wasserlöslichem Stift beschreibbar

12 sheets includes 6 self-adhesive and removable labels, use regular chalkboard markers and wipe clean with a clamp cloth

12 hojas, cada una con 6 motivos autoadhesivos, se pueden marcar con un rotulador lavable con agua

12 feuilles chacune avec 6 motifs autoadhésifs, on peut écrire avec un stylo lavable à l'eau

	cm	Farbe / Colour
00069	8,0 x 4,6	■



### Kreide-Marker, Stärke 2 mm, 2er Set

chalk marker, 2 pcs.  
rotulador de tiza, set de 2  
marqueur a la craie liquide, set de 2



Zum Gestalten und Beschriften von Tafeln, Glas und fast allen geschlossenen Oberflächen, deckende Flüssigkreide auf Wasserbasis, feucht abwischbar

For decorating and writing on boards, glass and almost all non-porous surfaces, opaque water-based liquid chalk, wet-wipeable

Rotuladores para pizarra de tiza líquida para decorar y escribir sobre pizarras, cristales y casi todas las superficies no porosas. Tizi líquida opaca al agua que se pueda borrar con un trapo

Pour décorations et inscriptions sur tableaux, verre et presque toutes les surfaces non poreuses, craie liquide opaque à base d'eau, effaçable avec un chiffon humide

	Ø cm	↑ cm	Farbe / Colour	pcs.
71490	1	13	■	2
71491	1	13	■	2

NEW

## TWO IN ONE



Fondue

13 tlg. Set  
13 pcs. set

Feuerzange



2,2 ltr.

65060

65061

6 Stk.  
6 pcs.

65062

## Fondue und Feuerzangenbowl-Set „TWO IN ONE“

fondue and fire punch bowl set  
set para fondue o ponche caliente  
service à fondue et à punch

13-teiliges Set aus Edelstahl bestehend aus:

1 Topf, 1 Rechaud, 1 Spritzschutz, 1 Untersetzer, 1 Schöpfkelle, 1 Feuerzange,  
1 Pastenbrenner, 6 Fonduegabeln

13-piece stainless steel set consisting of:

1 pot, 1 rechaud, 1 splash guard, 1 coaster, 1 ladle, 1 fire tongs,  
1 paste burner, 6 fondue forks

set de 13 piezas de acero inoxidable compuesto por:

1 olla, 1 rechaud, 1 protector contra salpicaduras, 1 trébede, 1 cazo,  
1 pinza para el fuego, 1 quemador de pasta, 6 tenedores de fondue

set de 13 pièces en acier inox comprenant:

1 marmite, 1 rechaud, 1 pare-éclaboussures, 1 dessous de plat, 1 louche, 1 pince à feu,  
1 brûleur à pâte, 6 fourchettes à fondueEDELSTAHL  
STAINLESS  
INOX  
18/8PP  
POLYPROP.

	Ø cm	↑ cm	ltr.
65060	22	23	2,2

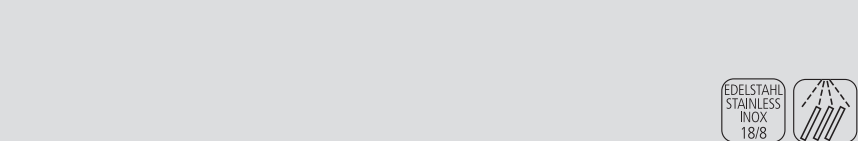
Brennpastenbehälter zu 65060 / fuel paste container for 65060 / recipiente para pasta de  
combustible para 65060 / récipient pour pâte à combustible pour 65060

	cm	↑ cm	fits to
65061	26 x 12	10	65060

EDELSTAHL  
STAINLESS  
INOX  
18/8

Gabelset zu 65060 / fork set for 65060 / set de tenedores para 65060 / set de fourchettes pour 65060

	cm	→ cm	pcs.	fits to
65062	24	Griff / handle 8	6	65060

EDELSTAHL  
STAINLESS  
INOXPP  
POLYPROP.









# Körbe

baskets

cestas

corbeilles

# SUPERSTRONG



## GN 1/1 Korb „SUPERSTRONG“

GN 1/1 basket  
GN 1/1 cesta  
GN 1/1 corbeille



	cm	↑ cm	GN	Farbe / Colour
50640	53 x 32,5	6,5	1/1	Yellow
50641	53 x 32,5	10,0	1/1	Yellow
50642	53 x 32,5	15,0	1/1	Yellow
50643	53 x 32,5	6,5	1/1	Dark Brown
50644	53 x 32,5	10,0	1/1	Dark Brown
50645	53 x 32,5	15,0	1/1	Dark Brown

## GN Kuppelhaube / GN cover / GN cúpula / GN cloche bombée

	cm	↑ cm	GN
11027	54 x 33	20	1/1

## GN Abdeckhaube / GN cover / GN cubierta / GN cloche

	cm	↑ cm	GN
11042	53 x 32,5	9,5	1/1

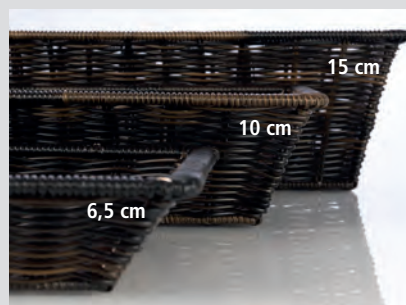



# PROFI LINE



**Korb "PROFI LINE"**  
basket baker size  
cesta tamaño panaderia  
corbeille dimensions „boul-pâte“



	cm	↑ cm	Farbe / Colour
50714	30 x 20	5	
50900	40 x 20	5	
50901	40 x 20	5	
50902	40 x 20	5	
50903	40 x 20	5	



**Korb "PROFI LINE"**  
basket baker size  
cesta tamaño panaderia  
corbeille dimensions „boul-pâte“



	cm	↑ cm	Farbe / Colour
50905	40 x 30	5	
50906	40 x 30	5	
50907	40 x 30	5	
50908	40 x 30	5	
	cm	↑ cm	Farbe / Colour
50710	40 x 30	10	
50711	40 x 30	10	
50713	40 x 30	10	
50712	40 x 30	10	



**Korb "PROFI LINE"**  
basket baker size  
cesta tamaño panaderia  
corbeille dimensions „boul-pâte“



	cm	↑ cm	Farbe / Colour
50910	60 x 20	5	
50911	60 x 20	5	
50912	60 x 20	5	
50913	60 x 20	5	



# BASKETS

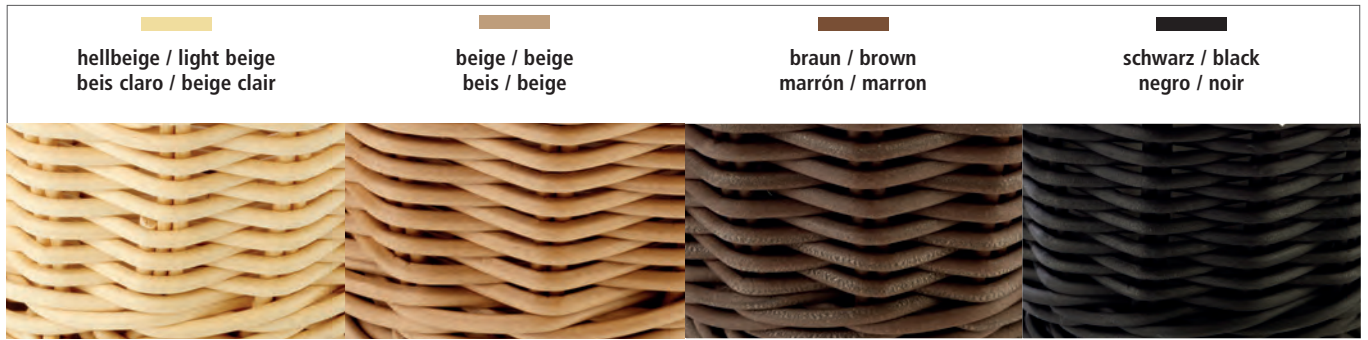

hellbeige / light beige  
beis claro / beige clair

beige / beige  
beis / beige

braun / brown  
marrón / marron

schwarz / black  
negro / noir



## Korb "PROFI LINE"

basket baker size  
cesta tamaño panaderia  
corbeille dimensions „boul-pâte"



	cm	↑ cm	Farbe / Colour
50915	60 x 40	5	hellbeige
50916	60 x 40	5	beige
50917	60 x 40	5	braun
50918	60 x 40	5	schwarz



## GN 1/1 Korb „PROFI LINE"

GN 1/1 basket  
GN 1/1 cesta  
GN 1/1 corbeille



	cm	↑ cm	Farbe / Colour
50720	53 x 32,5	10	hellbeige
50721	53 x 32,5	10	beige
50723	53 x 32,5	10	braun
50722	53 x 32,5	10	schwarz



## Korb, rechteckig „PROFI LINE"

basket, rectangular  
cesta, rectangular  
corbeille, rectangulaire



	cm	↑ cm	Farbe / Colour
50700	26,5 x 19	7	hellbeige
50701	26,5 x 19	7	beige
50703	26,5 x 19	7	braun
50702	26,5 x 19	7	schwarz

	cm	↑ cm	Farbe / Colour
50705	31 x 21	9	hellbeige
50706	31 x 21	9	beige
50708	31 x 21	9	braun
50707	31 x 21	9	schwarz



**Brötchenschütte „PROFI LINE“**

roll / bun basket  
cesta para bollos  
corbeille à petits pains



	cm	↑ cm
50510	60 x 40	60



**Stangenbrotkorb „PROFI LINE“**

baguette basket  
cesta de baguette  
corbeille à baguettes



	Ø cm	↑ cm	Farbe / Colour
50500	28 / 30	38	
50501	28 / 30	38	



**Auslage Tablett flach „PROFI LINE“**

display tray flat, baker size  
bandeja de presentación, tamaño panadería  
plateau de présentation, dimensions „boul-pâte“



	cm	↑ cm
40296	40 x 30	1
40297	60 x 40	1



## BASKETS



### Korb, rund „PROFI LINE“

basket, round  
cesta redonda  
corbeille ronde



	∅ cm	↑ cm
50210	37	9
50215	42	12



### Korb, rund „PROFI LINE“

basket, round  
cesta redonda  
corbeille ronde



	∅ cm	↑ cm
50205	31 / 37	12 / 6



### Korbschütte, rund „PROFI LINE“

basket, round  
cesta redonda  
corbeille ronde



	∅ cm	↑ cm
50100	36,5	12,0
50105	42,0	18,5
50110	46,0	18,5



### Systemkorb, gestäbt „PROFI LINE“

basket  
cesta  
corbeille



	cm	↑ cm
50300	30 x 40	27 / 16
50305	45 x 40	27 / 16
50310	60 x 40	27 / 16



### Systemkorb „PROFI LINE“

basket  
cesta  
corbeille



	cm	↑ cm
50400	40 x 50	25 / 14



### Trenner „PROFI LINE“

divider  
divisor  
paroi de séparation



	↑ cm	→ cm
50315	26 / 15	38



**Baguette Korb, oval „PROFI LINE“**

baguette basket, oval  
cesta de baguette, oval  
corbeille à baguettes, ovale



	cm	↑ cm	Farbe / Colour
50805	28 x 16	8	
50806	28 x 16	8	
50808	28 x 16	8	
50807	28 x 16	8	

	cm	↑ cm	Farbe / Colour
50823	40 x 16	8	



**Korb, oval „PROFI LINE“**

basket, oval  
cesta oval  
corbeille ovale



	cm	↑ cm	Farbe / Colour
50800	25 x 19	6,5	
50801	25 x 19	6,5	
50803	25 x 19	6,5	
50802	25 x 19	6,5	

	cm	↑ cm	Farbe / Colour
50815	32 x 23	7	
50816	32 x 23	7	
50818	32 x 23	7	
50817	32 x 23	7	



**Korb, rund „PROFI LINE“**

basket, round  
cesta redonda  
corbeille ronde



	Ø cm	↑ cm	Farbe / Colour
50600	16	8	
50601	16	8	
50603	16	8	
50602	16	8	

	Ø cm	↑ cm	Farbe / Colour
50605	20	8	
50606	20	8	
50608	20	8	
50607	20	8	

	Ø cm	↑ cm	Farbe / Colour
50610	29	7	
50611	29	7	
50613	29	7	
50612	29	7	



# BASKETS



50624

## Korb, oval „PROFI LINE“

basket, oval  
cesta, oval  
corbeille, ovale



	cm	↑ cm	Farbe / Colour
50624	19 x 12	6	
50625	19 x 12	6	
50627	19 x 12	6	
50626	19 x 12	6	



## Korb, rechteckig „PROFI LINE“

basket, rectangular  
cesta rectangular  
corbeille rectangulaire



	cm	↑ cm	Farbe / Colour
50632	17 x 11	9	
50633	17 x 11	9	
50635	17 x 11	9	
50634	17 x 11	9	

	cm	↑ cm	Farbe / Colour
50628	19 x 13	6	
50629	19 x 13	6	
50631	19 x 13	6	
50630	19 x 13	6	



## Korb, rund „PROFI LINE“

basket, round  
cesta, redonda  
corbeille, ronde



	Ø cm	↑ cm	Farbe / Colour
50620	13	10	
50621	13	10	
50623	13	10	
50622	13	10	

# GN LINE



2 Höhen - 6,5 und 10 cm  
2 heights - 6,5 and 10 cm



40293  
GN 1/1 - 10 cm



40292  
GN 1/2 - 10 cm

40225  
GN 1/4 - 6,5 cm

## Korb „GN LINE“

GN basket  
GN cesta  
GN corbeille



stabile Ausführung mit Edelstahldraht im Rand zur Stabilisierung  
very solid with stainless steel wire frame to stabilize the basket  
muy resistente con refuerzo de alambre inox  
très résistante avec son fil de renfort inox

	cm	↑ cm	GN	Farbe / Colour
40291	53,0 x 32,5	6,5	1/1	
40290	32,5 x 26,5	6,5	1/2	
40223	32,5 x 17,6	6,5	1/3	
40225	26,5 x 16,2	6,5	1/4	
40227	17,6 x 16,2	6,5	1/6	
40229	32,5 x 35,4	6,5	2/3	

	cm	↑ cm	GN	Farbe / Colour
40293	53,0 x 32,5	10,0	1/1	
40292	32,5 x 26,5	10,0	1/2	
40243	32,5 x 17,6	10,0	1/3	
40245	26,5 x 16,2	10,0	1/4	
40247	17,6 x 16,2	10,0	1/6	
40249	32,5 x 35,4	10,0	2/3	



GN 1/1

## GN 1/1 Besteckbehälter

GN 1/1 dispenser GN  
GN 1/1 dispensador de cubiertos  
GN 1/1 bac à couverts



in Handarbeit geflochten, 4 Mulden, Kunststoff-Geflecht, Drahtgestell, braun-schwarz  
wickerwork, 4 compartments, with reinforced chromed wire structure, brown-black  
cesta trensada a mano, 4 compartimentos, de plástico, con bastidor cromado reforzado, marrón oscuro  
corbeille tressée à main, 4 compartiments, en plastique, cadre acier chromé renforcé, couleur marron foncé

	cm	↑ cm	GN	Farbe / Colour
11966	53 x 32,5	9	1/1	



# GN LINE

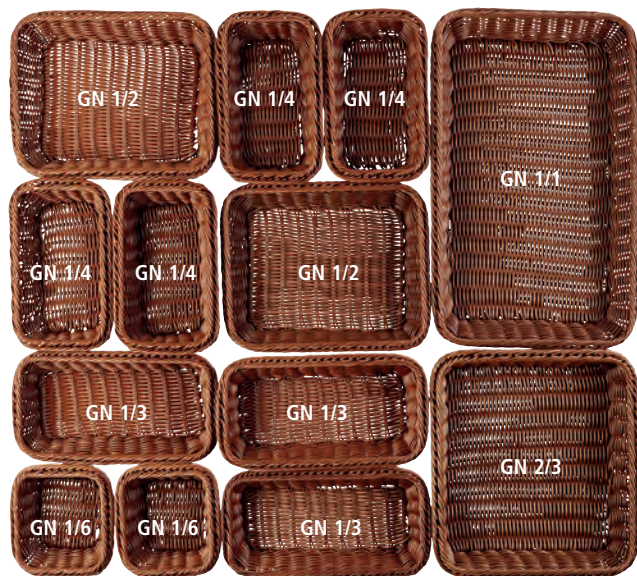
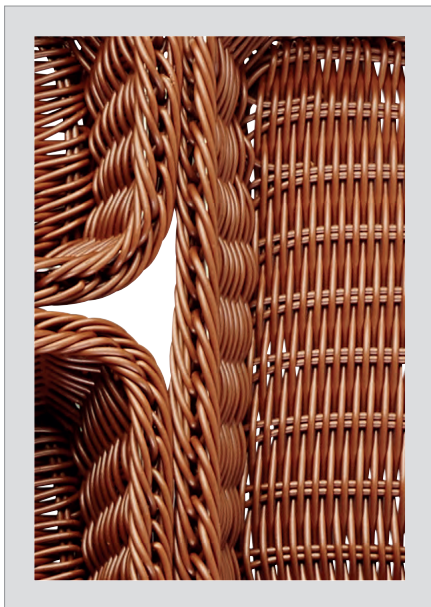

## Korb „GN LINE“

GN basket  
GN cesta  
GN corbeille



stabile Ausführung mit Edelstahldraht im Rand zur Stabilisierung  
very solid with stainless steel wire frame to stabilize the basket  
muy resistente con refuerzo de alambre inox  
très résistante avec son fil de renfort inox

	cm	↑ cm	GN	Farbe / Colour
40220	53,0 x 32,5	6,5	1/1	Yellow
40222	32,5 x 26,5	6,5	1/2	Yellow
40224	32,5 x 17,6	6,5	1/3	Yellow
40226	26,5 x 16,2	6,5	1/4	Yellow
40228	17,6 x 16,2	6,5	1/6	Yellow
40230	32,5 x 35,4	6,5	2/3	Yellow
	cm	↑ cm	GN	Farbe / Colour
40240	53,0 x 32,5	10	1/1	Yellow
40242	32,5 x 26,5	10	1/2	Yellow
40244	32,5 x 17,6	10	1/3	Yellow
40246	26,5 x 16,2	10	1/4	Yellow
40248	17,6 x 16,2	10	1/6	Yellow
40250	32,5 x 35,4	10	2/3	Yellow
	cm	↑ cm	GN	Farbe / Colour
40260	53,0 x 32,5	6,5	1/1	Brown
40262	32,5 x 26,5	6,5	1/2	Brown
40263	32,5 x 17,6	6,5	1/3	Brown
40264	26,5 x 16,2	6,5	1/4	Brown
40266	17,6 x 16,2	6,5	1/6	Brown
40268	32,5 x 35,4	6,5	2/3	Brown
	cm	↑ cm	GN	Farbe / Colour
40270	53,0 x 32,5	10	1/1	Brown
40272	32,5 x 26,5	10	1/2	Brown
40274	32,5 x 17,6	10	1/3	Brown
40276	26,5 x 16,2	10	1/4	Brown
40278	17,6 x 16,2	10	1/6	Brown
40280	32,5 x 35,4	10	2/3	Brown

# ECONOMIC



## Tisch- und Buffetkorb, rund „ECONOMIC“

buffet basket, round  
cesta de buffet, redonda  
corbeille de buffet, ronde



	Ø cm	↑ cm	Farbe / Colour
40132	19,0	9,5	
40135	25,5	8,5	
40144	39,0	10,0	
40191	19,0	9,5	
40192	25,5	8,5	



## Tisch- und Buffetkorb, oval „ECONOMIC“

buffet basket, oval  
cesta de buffet, oval  
corbeille de buffet, ovale



	cm	↑ cm	Farbe / Colour
40137	23,0 x 17	8,0	
40139	28,5 x 17	8,5	
40193	23,0 x 17	8,0	
40194	28,5 x 17	8,5	



stapelbar  
stackable



## Tisch- und Buffetkorb, eckig „ECONOMIC“

buffet basket, rectangular  
cesta de buffet, rectangular  
corbeille de buffet, rectangulaire



	cm	↑ cm	Farbe / Colour
40140	23,0 x 17	8	
40159	31,5 x 22	8,5	
40195	23,0 x 17	8	
40196	31,5 x 22	8,5	



## GN Buffetkorb „ECONOMIC“

GN basket  
GN cesta  
GN corbeille



	cm	↑ cm	GN	Farbe / Colour
40148	53 x 32,5	8	1/1	



## GN Buffetkorb „ECONOMIC“

GN basket  
GN cesta  
GN corbeille



	cm	↑ cm	GN	Farbe / Colour
40152	32,5 x 26,5	8	1/2	



# BASKETS



## Buffetkorb „ECONOMIC“

buffet basket  
cesta de buffet  
corbeille de buffet



**stabile Ausführung mit Edelstahldraht im Rand zur Stabilisierung**

very solid with stainless steel wire frame to stabilize the basket

muy resistente con refuerzo de alambre inox

très résistante avec son fil de renfort inox

	cm	↑ cm	GN
40129	53 x 32,5	15,5	1/1

**GN Kuppelhaube / GN cover / GN cúpula / GN cloche bombée**

	cm	↑ cm
11027	54 x 33	20



## Buffetkorb „ECONOMIC“

buffet basket  
cesta de buffet  
corbeille de buffet



**stabile Ausführung mit Edelstahldraht im Rand zur Stabilisierung**

very solid with stainless steel wire frame to stabilize the basket

muy resistente con refuerzo de alambre inox

très résistante avec son fil de renfort inox

	cm	↑ cm
40153	45 x 42	17 / 24



## Buffetkorb, rund „ECONOMIC“

buffet basket, round  
cesta de buffet, redonda  
corbeille de buffet ronde



**stabile Ausführung mit Edelstahldraht im Rand zur Stabilisierung**

very solid with stainless steel wire frame to stabilize the basket

muy resistente con refuerzo de alambre inox

très résistante avec son fil de renfort inox

	Ø cm	↑ cm	Farbe / Colour
40149	40	12,5	Yellow
40295	40	12,5	Black

**Rolltophaube / rolltop cover / campana abatible / cloche basculante**

	Ø cm	↑ cm	
18388	38	20	mit verchromtem Kugelgriff with chrome plated handle con pomo cromado / avec bouton chromé
18387	38	20	mit vergoldetem Kugelgriff / gold plated handle pomo dorado / bouton doré
18389	38	20	mit verchromtem Designergriff / with chrome plated designer handle



**Buffetkorb „ECONOMIC“**

buffet basket  
cesta de buffet  
corbeille buffet



in Handarbeit geflochten, stabile Ausführung, Edelstahl Fixierungsrahmen,  
zur Rutschsicherung, ohne Haube

wickerwork, stainless steel fix the cover, without cover

cesta trensada a mano, con marco cromado patentado para fijar  
y encajar la campana (se entrega sin la campana)

corbeille tressée main, cadre fil acier inoxydable pour fixer la cloche (livré sans la cloche)

	cm	↑ cm	Farbe / Colour
40150	56,5 x 36	10	
40294	56,5 x 36	10	

GN 1/1 Rolltop-Haube / GN 1/1 rolltop cover / GN 1/1 campana abatible  
GN 1/1 cloche basculante

	cm	↑ cm	GN	
11008	53 x 32,5	19	1/1	vergoldeter Griff / gold plated handle pomo dorado / bouton doré
11010	53 x 32,5	19	1/1	verchromter Griff / chrome plated handle pomo cromado / bouton chromé
11018	53 x 32,5	17	1/1	mit verchromtem Designergriff with chrome plated designer handle



**GN Kuppelhaube**

GN cover  
GN cúpula  
GN cloche bombée



glasklarer Kunststoff, Griff aus Zinkdruckguss

crystal clear plastic, die-cast zinc knob

plástico transparente, asa de zinc fundido a presión

plastique transparente, poignée en zinc moulé sous pression

	cm	↑ cm	GN	
11021	33 x 28	17	1/2	geschlossen / totally closed cerrada / tolement fermée
11022	33 x 28	17	1/2	mit Front-Ausschnitt / one long side cut out gran apertura frontal / grande ouverture frontale
11026	54 x 33	20	1/1	geschlossen / totally closed cerrada / tolement fermée
11027	54 x 33	20	1/1	mit Front-Ausschnitt / one long side cut out gran apertura frontal / grande ouverture frontale
11028	54 x 33	20	1/1	mit seitlichem Ausschnitt one small side cut out pequeña apertura lateral / petite ouverture latérale



**Eierkorb „PROFI LINE“**

egg basket  
cesta de huevos  
panier à oeufs



mit Edelstahldraht  
im Rand  
with stainless steel  
wire in the rim

für ca. 20 Eier, hält den Inhalt durch das Stoff-Futter lange warm

for around 20 eggs, keeps the eggs warm for a long time thanks to the fabric lining

para unos 20 huevos, mantiene los huevos calientes mucho tiempo gracias al forro de tela

pour env. 20 oeufs, garde les oeufs au chaud longtemps grâce à la doublure en tissu

	Ø cm	↑ cm	Farbe / Colour
40299	26	17	
30299	26	17	

stabile Vollweide  
willow, stable

# BASKETS



## Buffetgestell „DOPPELDECKER“ für GN

buffet frame for GN  
estructura para buffet para GN  
support buffet pour GN



2-teilig, einfach zusammensetzbar, Etagen-Abstand ca. 26 cm, platzsparend, stabile Ausführung  
2 pcs., easy to assemble, distance between the tiers approx. 26 cm, space-saving, robust  
2 pzas, fácil de montar, distancia entre pisos aprox. 26 cm, robusto  
2 pcs, assemblage facile, distance entre niveaux approx. 26 cm, robuste

	cm	↑ cm	fits to GN
11555	50 x 34	37,5	1/1
11553	29 x 27	35,0	1/2



## Baguettekorb „ECONOMIC“

baguette basket  
cesta para baguette  
corbeille pour baguettes



stabile Ausführung mit Edelstahldraht im Rand zur Stabilisierung  
very solid with stainless steel wire frame to stabilize the basket  
muy resistente con refuerzo de alambre inox  
très résistante avec son fil de renfort inox

	Ø cm	↑ cm	Farbe / Colour
40198	35	24 / 42	Yellow



## Besteckkorb „ECONOMIC“

cutlery dispenser  
dispensador de cubiertos  
corbeille à couverts



4 Fächer (3 kleine und 1 großes) / 4 compartments (3 small and 1 large) /  
4 compartimentos (3 pequeños y 1 grande) / 4 compartiments (3 petits et 1 grand)

	cm	↑ cm	Farbe / Colour
40179	26 x 18	15	Yellow
40182	26 x 18	15	Black







**Brot- und Obstkorb „WICKER LOOK“**

basket for bread or fruits  
cesta para pan o fruta  
corbeille à pain ou à fruits



	Ø cm	↑ cm	Farbe / Colour
40214	20	6,5	
40216	23 x 17	6,5	

	cm	↑ cm	Farbe / Colour
40211	39,5 x 29,5	10	
40212	39,5 x 29,5	10	
40210	39,5 x 29,5	10	



**Besteckkorb „ECONOMIC“**

cutlery dispenser  
dispensador de cubiertos  
corbeille à couverts



in Handarbeit geflochten  
wickerwork  
trensado a mano  
tressage à main

	Ø cm	↑ cm	Farbe / Colour
40130	12	15	
40007	12	15	
40012	12	15	
40013	12	15	



**Besteckkorb „ECONOMIC“**

cutlery dispenser  
dispensador de cubiertos  
corbeille à couverts



in Handarbeit geflochten  
wickerwork  
trensado a mano  
tressage à main

	cm	↑ cm	Farbe / Colour
40131	27 x 10	4,5	
40009	27 x 10	4,5	
40010	27 x 10	4,5	
40011	27 x 10	4,5	



# BASKETS

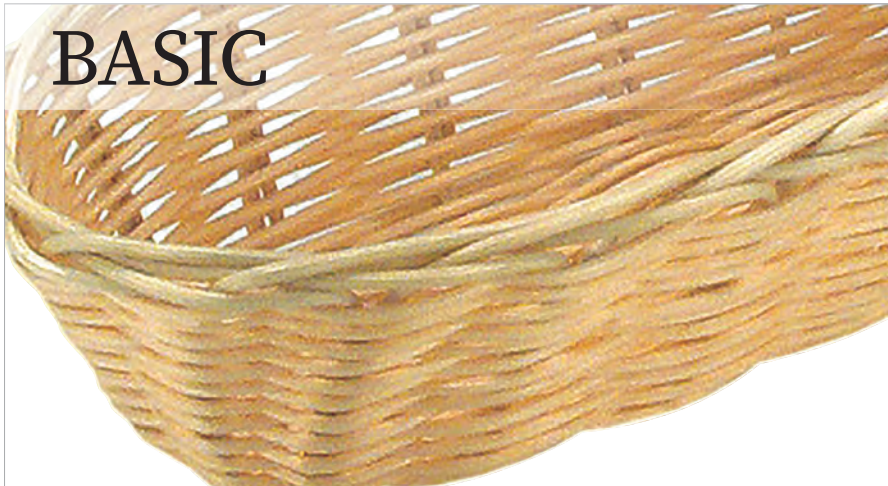

- in Handarbeit geflochten, einfache und leichte Ausführung
- wickerwork, simple and light version
- ligera, trensada a mano
- tressé à main, version légère



## Brot- und Obstkorb oval „BASIC“

basket for bread or fruits  
cesta para pan o fruta  
corbeille à pain ou à fruits



	cm	↑ cm
30279	18 x 12	7
30280	23 x 15	6



## Brot- und Obstkorb oval „BASIC“

basket for bread or fruits  
cesta para pan o fruta  
corbeille à pain ou à fruits



	cm	↑ cm
30282	21 x 10	6
30284	36 x 15	7



## Brot- und Obstkorb rund „BASIC“

basket for bread or fruits  
cesta para pan o fruta  
corbeille à pain ou à fruits



	Ø cm	↑ cm
30281	20	7
30285	25	7



## Tisch- und Buffetkorb rechteckig „BASIC“

buffet basket  
cesta de buffet  
corbeille de buffet



	cm	↑ cm
30286	30 x 22	7
30288	41 x 29	7
30283	22 x 15	6



## Brot- und Obstkorb quadratisch „BASIC“

basket for bread or fruits  
cesta para pan o fruta  
corbeille à pain ou à fruits



	cm	↑ cm
30287	24 x 24	6

# Brottasche

Umgekrempelt kann die Höhe individuell gestaltet werden!



## Brottasche

bread basket  
panera  
corbeille



70% Naturfaser und 30% Kunstharz  
70% natural fibre and 30% synthetic resin  
70% fibra natural y 30% resina sintética  
70% de fibres naturelles et 30% de résine synthétique

	Ø cm	↑ cm	Farbe / Colour
30440	17	11	Yellow
30450	20	13	Yellow
30442	24	24	Yellow
30443	30	22	Yellow
30441	17	11	Black
30451	20	13	Black
30445	24	24	Black
30446	30	22	Black



## Brottasche

bread basket  
panera  
corbeille



70% Naturfaser und 30% Kunstharz  
70% natural fibre and 30% synthetic resin  
70% fibra natural y 30% resina sintética  
70% de fibres naturelles et 30% de résine synthétique

	cm	↑ cm	Farbe / Colour
30444	30 x 20	18	Yellow
30447	30 x 20	18	Black

umgekrempelt kann die Höhe individuell gestaltet werden  
adjustable height by turning the edge upside down  
altura ajustable girando el borde al revés  
hauteur ajustable en tournant le bord à l'envers

# BASKETS



## Brottasche bread basket panera corbeille



**70% Naturfaser und 30% Kunstharz**  
70% natural fibre and 30% synthetic resin  
70% fibra natural y 30% resina sintética  
70% de fibres naturelles et 30% de résine synthétique

	cm	↑ cm	Farbe / Colour
30355	12 x 11,5	11,5	
30356	12 x 11,5	11,5	



**umgekrempelt kann die Höhe individuell gestaltet werden**  
adjustable height by turning the edge upside down  
altura ajustable girando el borde al revés  
hauteur ajustable en tournant le bord à l'envers



## Brottasche bread basket panera corbeille

KUNST  
FASER  
TETRON



**schmutzabweisende Kunstfaser, 30°C waschbar**  
dirt-repellent synthetic fibre, washable 30°C  
fibra sintética repelente a la suciedad, lavable a 30°C  
fibre synthétique anti-salissante, lavable à 30°C

	Ø cm	↑ cm	Farbe / Colour
30345	17	11,5	
30346	20	13,5	



## Brottasche bread basket panera corbeille

KUNST  
FASER  
TETRON



**schmutzabweisende Kunstfaser, 30°C waschbar**  
dirt-repellent synthetic fibre, washable 30°C  
fibra sintética repelente a la suciedad, lavable a 30°C  
fibre synthétique anti-salissante, lavable à 30°C

	cm	↑ cm	Farbe / Colour
30347	19 x 11	10,5	
30348	24 x 16	10,5	



**Präsentationsmöglichkeit**  
presentation example





30350 rund / round

30371 oval

**Brottasche**

bread basket  
panera  
corbeille à pain en toile



Baumwolle, umgekrempelt kann die Höhe individuell gestaltet werden, maschinenwaschbar bis 30°C, rund oder oval  
cotton, adjustable height, mashine-washable 30°C, round or oval  
algodón, altura ajustable, lavable a máquina 30°C, redondo u oval  
coton, hauteur ajustable, lavable en machine maxi 30°C, rond ou ovale

	Ø cm	↑ cm	Farbe / Colour
30340	17	11	
30350	20	12	
30341	17	11	
30351	20	12	
30360	20 x 15	10	
30370	25 x 18	12	
30361	20 x 15	10	
30371	25 x 18	12	



mit Zugverschluss

Das Wärmekissen einfach in der Mikrowelle erhitzen (90 Sekunden / 500 Watt)

maschinenwaschbar bis 30°C (außer Kissen)

**Brottasche mit Wärmekissen**

bread basket with stones pillow  
panera con cojín  
corbeille à pain en toile avec coussin chauffant



Baumwolle, Keramik-Kugeln, maschinenwaschbar bis 30°C  
cotton, ceramic stones, mashine-washable 30°C  
algodón, bolas de cerámica, lavable a máquina 30°C  
coton, billes de céramiques, lavable en machine maxi 30°C

	Ø cm	↑ cm	Farbe / Colour
30380	19	23	
30390	19	23	

Wärmekissen / stones pillow / cojín de piedrecillas a calentar / coussin de petites pierres, à chauffer

	Ø cm	↑ cm
30385	19	1,5



30205

30206

**Brot- und Obstkorb „WIRE“**

wire basket  
cesta para pan o fruta  
corbeille pour pain ou fruits



	Ø cm	↑ cm	Farbe / Colour
30205	31	14	metal chrome
30206	31	14	metal black



## BASKETS

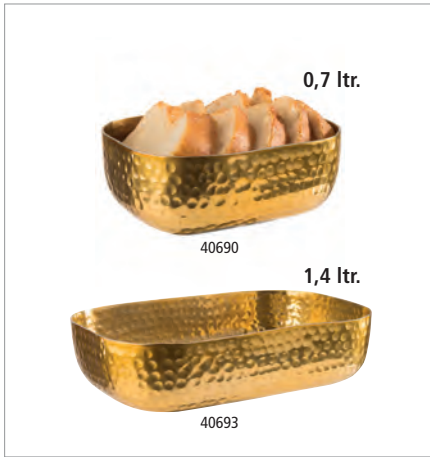

### Schale

bowl  
cuenco  
bol



gehämmerte Oberfläche  
hammered surface  
superficie martillada  
surface martelée

	cm	↑ cm	ltr.	Farbe / Colour
40690	15,5 x 12,0	5,5	0,7	gold look
40693	23,0 x 15,5	6,0	1,4	gold look

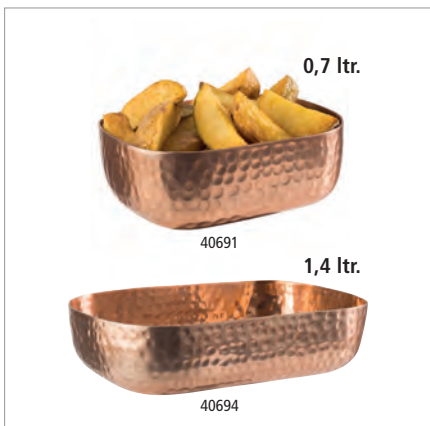

### Schale

bowl  
cuenco  
bol



gehämmerte Oberfläche  
hammered surface  
superficie martillada  
surface martelée

	cm	↑ cm	ltr.	Farbe / Colour
40691	15,5 x 12,0	5,5	0,7	copper look
40694	23,0 x 15,5	6,0	1,4	copper look



### Schale

bowl  
cuenco  
bol



gehämmerte Oberfläche  
hammered surface  
superficie martillada  
surface martelée

	cm	↑ cm	ltr.	Farbe / Colour
40692	15,5 x 12,0	5,5	0,7	gunmetal-look
40695	23,0 x 15,5	6,0	1,4	gunmetal-look



### Servierkorb „BURGER & FRIES“

serving basket  
cesta para servir  
corbeille de service



Servierkorb aus Metall mit 2 Haltern für Dipschälchen

metal serving basket with 2 holders for dip bowls

cesta de metal para servir con 2 soportes para cuencos para dip

corbeille de service en métal avec 2 supports pour ramequins

	cm	↑ cm
40604	39,5 x 20	11

passende Schälchen / fitting bowls / cuencos adecuados / bols apropiés



	Ø cm	↑ cm	ltr.	VE / unit
83781	7	3,7	0,05	24



**Korb „URBAN“**

basket  
cesta  
corbeille



	Ø cm	↑ cm	Farbe / Colour
30410	17	7,0	■
30411	20	8,5	■



**Korb „URBAN“**

basket  
cesta  
corbeille



	cm	↑ cm	Farbe / Colour
30412	21 x 10	7	■
30413	30 x 14	12	■



**Korb „URBAN“**

basket  
cesta  
corbeille



	cm	↑ cm	Farbe / Colour
30337	29 x 16	7	■



**GN Korb „URBAN“**

GN basket  
GN cesta  
GN corbeille



	cm	↑ cm	GN	Farbe / Colour
30414	53,0 x 32,5	7,5	1/1	■
30415	32,5 x 26,5	7,5	1/2	■
30416	53,0 x 16,2	7,5	2/4	■

**GN Abdeckhaube / GN cover / GN cubierta / GN cloche**

	cm	↑ cm	GN	
11044	53 x 16,2	10,5	2/4	
11042	53 x 32,5	9,5	1/1	ohne Abbildung
11022	33 x 28,0	17,0	1/2	ohne Abbildung
11027	54 x 33,0	20,0	1/1	

## BASKETS



Korb „SVART“  
basket  
cesta  
corbeille

Black  
is  
beautiful



	Ø cm	↑ cm	Farbe / Colour
30420	17,5	8	■
30421	20,0	8	■



Korb „SVART“  
basket  
cesta  
corbeille

Black  
is  
beautiful



	cm	↑ cm	Farbe / Colour
30422	20 x 15	8	■
30423	24 x 19	8	■

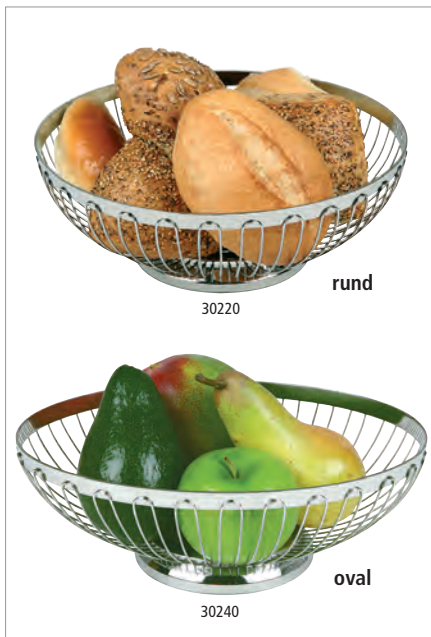

Brot- und Obstkorb  
basket for bread or fruits  
cesta para pan o fruta  
corbeille à pain ou à fruits



hochglanzpoliert  
mirror polished finish  
acabado pulido brillante  
brillant

	Ø cm	↑ cm
30200	17,5	7,0
30220	20,5	8,5
30230	25,5	9,5

	cm	↑ cm
30210	20 x 15	7,0
30240	24 x 19	8,5
30250	28 x 21	9,5



Obstkorb  
basket for fruits  
cesta para fruta  
corbeille à fruits



hochglanzpoliert  
mirror polished finish  
acabado pulido brillante  
brillant

	Ø cm	↑ cm
30270	21,5	20,5



**Lunchbag, 2er Set**

lunch bag, 2 pcs.  
bolsa de almuerzo, set de 2  
sac à lunch, set de 2

70%  
NATURFASER  
30%  
KUNSTHARZ



70% Naturfaser und 30% Kunstharz  
70% natural fibre and 30% synthetic resin  
70% fibra natural y 30% resina sintética  
70% de fibres naturelles et 30% de résine synthétique

	cm	↑ cm
30357	16 x 10	32
30358	25 x 15	30



mit Klettverschluss  
with velcro fastener  
con cierre de velcro  
avec fermeture velcro



**Brot- und Obstkorb**

basket for bread or fruits  
cesta para pan o fruta  
corbeille à pain ou fruits

METALL



	Ø cm	↑ cm	Farbe / Colour
30207	21	16,5	copper-look handle
30208	30	19,0	copper-look handle



**Brot- und Obstkorb**

basket for bread or fruits  
cesta para pan o fruta  
corbeille à pain ou fruits

METALL  
VERCHROMT



	Ø cm	↑ cm
30310	18	7,5

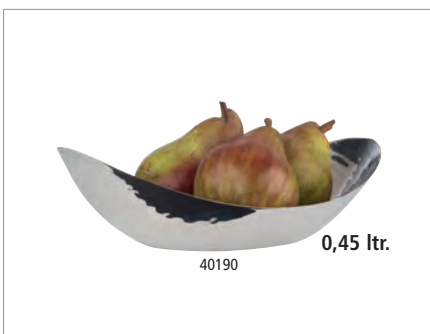

**Schale**

bowl  
cuenco  
bol

EDELSTAHL  
STAINLESS  
INOX



gehämmerte Oberfläche / hammered surface / superficie martillada / surface martelée

	cm	↑ cm	ltr.
40189	20 x 13,5	5,5	0,30
40190	24 x 16,5	7,0	0,45



## BASKETS



### Brot- und Obstschale

bowl for bread or fruits  
bol para pan o fruta  
bol à pain ou à fruits

EDELSTAHL  
STAINLESS  
INOX



hochglanzpoliert, Hammerschlag Optik  
mirror polished finish, hammered look  
acabado pulido efecto espejo, aspecto repujado  
brillant, aspect martelé

	Ø cm	↑ cm
30276	16	5,0
30277	20	5,5



### Schale

bowl  
bandeja  
corbeille

EDELSTAHL  
STAINLESS  
INOX



ingerollter Rand  
rolled edge  
borde redondeado  
bord roulé

	cm	↑ cm
40110	26,5 x 18,5	4,0
40115	31,0 x 21,0	4,5



### Korb / Ständer „APS PLUS“

basket / riser  
cesta / soporte  
corbeille / support

METALL



	Ø cm	↑ cm	Farbe / Colour
15320	10,5 / 8	8	 polished chrome
15324	10,5 / 8	8	 brushed gold
15322	10,5 / 8	8	 brushed copper



### Korb / Ständer „APS PLUS“

basket / riser  
cesta / soporte  
corbeille / support

METALL



	Ø cm	↑ cm	Farbe / Colour
15321	21 / 15	11	 polished chrome
15325	21 / 15	11	 brushed gold
15323	21 / 15	11	 brushed copper



**Korb / Ständer „ASIA PLUS“**

basket / riser  
cesta / soporte  
corbeille / support



	Ø cm	↑ cm	Farbe / Colour
15331	15	10,5	polished chrome
15332	21	20,0	polished chrome
15334	15	10,5	brushed gold
15335	21	20,0	brushed gold



**Korb / Ständer „ASIA PLUS“**

basket / riser  
cesta / soporte  
corbeille / support



	Ø cm	↑ cm	Farbe / Colour
15326	21 / 15	21	



**Buffetständer / -korb „ASIA PLUS“**

buffet stand / basket  
soporte para buffet / cesta  
présentoir buffet / corbeille



	Ø cm	↑ cm	Farbe / Colour
15507	15	10,5	



**Buffetständer / -korb „ASIA PLUS“**

buffet stand / basket  
soporte para buffet / cesta  
présentoir buffet / corbeille



	Ø cm	↑ cm	Farbe / Colour
15508	21	10,5	



**Buffetständer / -korb „ASIA PLUS“**

buffet stand / basket  
soporte para buffet / cesta  
présentoir buffet / corbeille



	Ø cm	↑ cm	Farbe / Colour
15509	21	20	









# Chafing Dish, GN Container & Transport



# EASY INDUCTION



die Deckelbremse sorgt für langsames Schließen

the revolving cover closes gently, thanks to a special built-in axle

sistema de freno para un cierre suave de la tapa

système avec frein pour une fermeture en douceur du couvercle



Druckhebel zum leichten Entnehmen des GN-Behälters

stick for easy removing of the GN-container

dispositivo para levantar y quitar con facilidad la cubeta GN

dispositif pour lever et retirer facilement le bac GN



abnehmbarer Glas-Deckel mit Wasserrücklaufsystem

removable glass lid, with water-runback-system

tapa transparente desmontable con sistema de retorno de la condensación

couvercle transparent amovible avec système de retour de la condensation



Fixierschraube verhindert das Rutschen

fixing screw for skid resistance

Pie trasero anti-deslizante, altura regulable

Pied supplémentaire anti-dérapant réglable en hauteur

**Lieferung ohne Induktionskochplatte**  
delivery without induction plate  
se entrega sin placa de inducción  
livré sans plaque à induction

## GN 1/1 Chafing Dish „EASY INDUCTION“



1 Gestell + 1 Wasserbecken mit Sandwichboden + 1 Deckel mit hydraulischem Gelenk + 1 GN 1/1 Behälter 65 mm tief, hitzebeständige Griffe, hochwertige Verarbeitung, ausschließlich für Induktionskochfelder

1 frame + 1 waterpan with sandwich base + 1 hydraulic cover + 1 GN 1/1 container 65 mm, heat-resistant handles, high quality, only for induction plates

1 marco + 1 baño maría con base sandwich + 1 marco con tapa hidráulica + 1 cubeta GN 1/1 pan 65 mm profundo, asas resistentes al calor, buenos acabados, solamente para inducción

1 pied support + 1 bac bain-marie avec fond sandwich + 1 cadre avec couvercle hydraulique + 1 bac GN 1/1 - 65mm, poignées résistantes à la chaleur, belle qualité, uniquement pour induction

	cm	↑ cm	GN	ltr.
12322	60 x 42	30	1/1	9



**Lieferung ohne Induktionskochplatte**  
delivery without induction plate  
se entrega sin placa de inducción  
livré sans plaque à induction

## GN 2/3 Chafing Dish „EASY INDUCTION“



1 Gestell + 1 Wasserbecken mit Sandwichboden + 1 Wasserbeckenrahmen + 1 Deckel mit hydraulischem Gelenk + 1 GN 2/3 Behälter 65 mm tief, hitzebeständige Griffe, hochwertige Verarbeitung, ausschließlich für Induktionskochfelder

1 frame + 1 waterpan with sandwich base + 1 frame for waterpan + 1 hydraulic cover + 1 GN 2/3 container 65 mm, heat-resistant handles, high quality, only for induction plates

1 marco + 1 baño maría con base sandwich + 1 marco con tapa hidráulica + 1 cubeta GN 2/3 pan 65 mm profundo, asas resistentes al calor, buenos acabados, solamente para inducción

1 pied support + 1 bac bain-marie avec fond sandwich + 1 cadre avec couvercle hydraulique + 1 bac GN 2/3 - 65mm, poignées résistantes à la chaleur, belle qualité, uniquement pour induction

	cm	↑ cm	GN	ltr.
12323	42 x 41	30	2/3	5,5





Lieferung ohne Induktionskochplatte  
delivery without induction plate  
se entrega sin placa de inducción  
livré sans plaque à induction

Chafing Dish „EASY INDUCTION“



1 Gestell + 1 Wasserbecken mit Sandwichboden + 1 Deckel mit hydraulischem Gelenk + 1 runder Speisenbehälter, hitzebeständige Griffe, hochwertige Verarbeitung, ausschließlich für Induktionskochfelder geeignet

1 frame + 1 waterpan with sandwich base + 1 hydraulic cover + 1 round foodpan, heat-resistant handles, high quality, good for induction plates

1 soporte + 1 baño maría con base sandwich + 1 tapa hidráulica + 1 cubeta redonda, asas resistente al calor, buen acabado, apto para inducción

1 pied support + 1 bac bain-marie avec fond sandwich + 1 cadre avec couvercle hydraulique + 1 bac rond, poignées résistantes à la chaleur, belle qualité, uniquement pour induction

	cm	↑ cm	ltr.
12324	46 x 50	30	6



Lieferung ohne Induktionskochplatte  
delivery without induction plate  
se entrega sin placa de inducción  
livré sans plaque à induction

Chafing Dish „EASY INDUCTION“



1 Gestell + 1 Wasserbecken mit Sandwichboden + 1 Deckel mit hydraulischem Gelenk + 1 runder Speisenbehälter, hitzebeständige Griffe, hochwertige Verarbeitung, ausschließlich für Induktionskochfelder geeignet

1 frame + 1 waterpan with sandwich base + 1 hydraulic cover + 1 round foodpan, heat-resistant handles, high quality, good for induction plates

1 soporte + 1 baño maría con base sandwich + 1 tapa hidráulica + 1 cubeta redonda, asas resistente al calor, buen acabado, apto para inducción

1 pied support + 1 bac bain-marie avec fond sandwich + 1 cadre avec couvercle hydraulique + 1 bac rond, poignées résistantes à la chaleur, belle qualité, uniquement pour induction

	cm	↑ cm	ltr.
12325	48 x 42	39	11



Induktionskochplatte für Chafing Dish

induction plate for chafing dish  
placa de inducción para chafing dish  
plaque à induction pour chafing dish

mit Regler  
with power control  
con control de potencia  
avec régulateur

	Ø cm	
12295	24	900 W



82210  
4,3 ltr.

82215  
2 x 2 ltr.

Porzellan-Einsatz  
porcelain insert  
bandeja de porcelana  
bac supérieur en porcelaine



	Ø cm	↑ cm	ltr.	fits to
82210	39	6	4,3	12324
82215	39	6	4,0	12324

# PREMIUM



**langlebige Deckelbremse**  
Abnehmbarer Deckel, dieser lässt sich spielend leicht öffnen und schließen, der Lauf des Deckels wird professionell gedämpft.



**Kondenswasser - Rücklaufsystem**  
Kondenswasser wird in das Wasserbecken zurückgeführt.



**Sandwichboden / Kapselboden**  
Induktionsfähiger Boden, direkt auf dem Induktionskochfeld einsetzbar. Perfekte Wärmeverteilung und Steuerung.



**Fixierschraube / Rutschsicherung**  
Höhenverstellbares Gelenk, fixiert das Gerät in dem Gestell und auf dem Tisch.



**Induktionskochplatte Nr. 12295**  
Induktionskochplatte wird einfach in das Gestell gelegt.



**stapelbar**  
Chafing Dish Rahmen sind übereinander stapelbar. Platzsparend und rutschfest stapeln und transportieren.



## Induktionskochplatte für Chafing Dish

induction plate for chafing dish  
placa de inducción para chafing dish  
plaque à induction pour chafing dish

mit Regler  
with power control  
con control de potencia  
avec régulateur

	Ø cm	
12295	24	900 W





12370

**Lieferung ohne Induktionskochplatte**  
delivery without induction plate  
se entrega sin placa de inducción  
livré sans plaque à induction

GN 1/1 Chafing Dish „PREMIUM“



1 Gestell + 1 Wasserbecken mit Sandwichboden + 1 Wasserbeckenrahmen + 1 Deckel mit hydraulischem Gelenk + 1 GN 1/1 Behälter 65 mm tief, hitzebeständige Griffe, hochwertige Verarbeitung, ausschließlich für Induktionskochfelder

1 frame + 1 waterpan with sandwich base + 1 frame for waterpan + 1 hydraulic cover + 1 GN 1/1 container 65 mm, heat resistant handles, high quality, only for induction plates

1 soporte + 1 cubeta baño maría con base sandwich + 1 marco para cubeta baño maría + 1 tapa hidráulica + 1 cubeta GN 1/1 de 65 mm, asas resistentes al calor, acabado de alta calidad, solamente para inducción

1 pied support + 1 bac bain-marie avec fond sandwich + 1 cadre pour bac bain-marie + 1 couvercle hydraulique + 1 bac GN 1/1 de 65 mm, poignées résistantes à la chaleur, finition de qualité, uniquement pour induction

	cm	↑ cm	ltr.	
12370	66 x 48	33	9	mit Edelstahldeckel with stainless steel cover
12352	66 x 48	33	9	mit Glasdeckel with glass cover



12353

**Lieferung ohne Induktionskochplatte**  
delivery without induction plate  
se entrega sin placa de inducción  
livré sans plaque à induction

Chafing Dish rund „PREMIUM“



1 Gestell + 1 Wasserbecken mit Sandwichboden + 1 Wasserbeckenrahmen + 1 Deckel mit hydraulischem Gelenk + 1 runder Speisenbehälter, hitzebeständiger Griff, hochwertige Verarbeitung, für Induktionskochfelder geeignet

1 frame + 1 waterpan with sandwich base + 1 frame for waterpan + 1 hydraulic cover + 1 round foodpan, heat resistant handle, high quality, suitable for induction plates

1 soporte + 1 cubeta baño maría con base sandwich + 1 marco para cubeta baño maría + 1 tapa hidráulica + 1 cubeta redonda, asa resistente al calor, acabado de alta calidad, apto para inducción

1 pied support + 1 bac bain-marie avec fond sandwich + 1 cadre pour bac bain-marie + 1 couvercle hydraulique + 1 bac rond, poignée résistante à la chaleur, finition de qualité, apte pour induction

	cm	↑ cm	ltr.	
12371	44 x 54	33	6	mit Edelstahldeckel with stainless cover
12353	44 x 54	33	6	mit Glasdeckel with glass cover

Speiseneinsatz / foodpan / cubeta / bac supérieur

12366



12372

**Lieferung ohne Induktionskochplatte**  
delivery without induction plate  
se entrega sin placa de inducción  
livré sans plaque à induction

Chafing Dish rund „PREMIUM“



1 Gestell + 1 Wasserbecken mit Sandwichboden + 1 Wasserbeckenrahmen + 1 Deckel mit hydraulischem Gelenk + 1 runder Speisenbehälter, hitzebeständige Griffe, hochwertige Verarbeitung, für Induktionskochfelder geeignet

1 frame + 1 waterpan with sandwich base + 1 frame for waterpan + 1 hydraulic cover + 1 round foodpan, heat resistant handles, high quality, suitable for induction plates

1 soporte + 1 cubeta baño maría con base sandwich + 1 marco para cubeta baño maría + 1 tapa hidráulica + 1 cubeta redonda, asas resistentes al calor, acabado de alta calidad, apto para inducción

1 pied support + 1 bac bain-marie avec fond sandwich + 1 cadre pour bac bain-marie + 1 couvercle hydraulique + 1 bac rond, poignées résistantes à la chaleur, finition de qualité, apte pour induction

	cm	↑ cm	ltr.	
12372	44 x 48	39	10	mit Edelstahldeckel with stainless cover
12354	44 x 48	39	10	mit Glasdeckel with glass cover

Speisenbehälter / foodpan / cubeta superior / bac supérieur

12397

# GLOBE



die Deckelbremse sorgt für langsames Schließen

the revolving cover closes gently, thanks to a special built-in axle

resistencia los frenos del sistema garantizan un cierre suave de la tapa

système avec frein pour une fermeture en douceur du couvercle



abnehmbarer Deckel mit Wasserrücklaufsystem

lid can be taken off, with water runback system

tapa fácil de desmontar, y canal incorporado para recuperar el agua condensada

couvercle facile à démonter, rainure pour récupérer les gouttes de condensation



Kondenswasser wird in das Wasserbecken zurückgeführt

condensed water is led back into the waterpan

el agua de condensación vuelve a la cubeta de agua

l'eau de condensation retourne dans le bac d'eau



für alle Herdarten geeignet, auch für Induktionskochplatten

suitable for all kinds of ovens, even induction cookers

apto para todas las fuentes de calor, incluso inducción

apte pour toutes les sources de chaleur, y compris induction



## GN 1/1 Chafing Dish „GLOBE“



hochglanzpoliert, mit abnehmbarem hydraulischem Edelstahl-Deckel, Sandwichboden sorgt für optimale Wärmeleitung, für Induktionsplatten geeignet, Set: Gestell + Wasserbecken + Speisenbehälter GN 1/1 65 mm tief, 9 Liter + Löffelablage + 2 Brennpastenbehälter + Metallrahmen für Induktionskochplatte

mirror polished finish, removable stainless steel hydraulic cover, sandwich base for optimum heat distribution, suitable for induction plates

set: frame + waterpan + GN 1/1 container 65 mm, 9l + cutlery compartment ladles + 2 burner holder + frame for induction plate

pulido brillante, tapa hidráulica de acero inoxidable extraíble, fondo difusor sandwich apto para inducción, incluye: soporte + cubeta baño maría + cubeta GN 1/1 de 65 mm, 9 l + soporte para cuchara (sin cuchara) + 2 quemadores + marco para la placa de inducción

poli brillant, couvercle inox hydraulique amovible, fond diffuseur sandwich apte pour induction, comprend: pied support + bac bain-marie + bac GN 1/1 de 65 mm, 9 l + porte-louche (louche non incluse) + 2 brûleurs + cadre inox pour la plaque à induction

	cm	↑ cm	ltr.	
12394	66,5 x 44	34	9	mit Edelstahldeckel with stainless cover
12404	66,5 x 44	34	9	mit Glasdeckel with glass cover

Induktionskochplatte für Chafing Dish / induction plate for chafing dish / placa de inducción para chafing dish / plaque à induction pour chafing dish

12295

Metallrahmen für Induktionskochplatte / frame for induction plate / estructura o marco para placa de inducción / cadre support inox pour plaque induction

12296



**Suppen-Kugel inkl. Gestell „GLOBE“**

soup bowl with stand  
cubeta sopa con soporte  
récipient à soupe avec pied



hochglanzpoliert, inkl. Speisenbehälter, 1 Brennpastenbehälter, mit einhängbarer Löffelablage, Sandwichboden sorgt für optimale Wärmeverteilung, für Induktionsplatten geeignet, einfaches Anbringen und Entfernen des Deckels, hitzeisolierende Griffe, 1 Metallrahmen für Induktionskochplatten

mirror polished finish, incl. foodpan and 1 burner holder, with fitting compartment for ladles, sandwich bottom for optimum heat distribution, gentle opening of the lid, heat-resistant handles, frame for induction plate

acabado pulido brillante, cubeta sopa inox, 1 quemador, platillo a colgar para el cucharón, fondo difusor sandwich, apto para inducción, tapa con apertura controlada, asas frías, marco para placa de inducción

poli brillant, récipient à soupe inox, 1 brûleur, repose-couvert à accrocher, fond diffuseur sandwich, apte pour induction, couvercle à ouverture contrôlée, anses froides, cadre support inox pour plaque à induction

	Ø cm	↑ cm	ltr.
12398	48	45	10

**Induktionskochplatte für Chafing Dish / induction plate for chafing dish / placa de inducción para chafing dish / plaque à induction pour chafing dish**

12295

**Metallrahmen für Induktionskochplatten / frame for induction plate / marco para placa de inducción / cadre support inox pour plaque induction**

12291



**Suppen-Kugel „GLOBE“**

soup bowl  
cubeta sopa  
récipient à soupe



hochglanzpoliert, inkl. Speisenbehälter, mit einhängbarer Löffelablage, Sandwichboden sorgt für optimale Wärmeverteilung, für Induktionsplatten geeignet, einfaches Anbringen und Entfernen des Deckels, hitzeisolierende Griffe (Lieferung ohne Gestell, Löffel)

mirror polished finish, incl. foodpan, with fitting compartment for ladles, sandwich bottom for optimum heat distribution, gentle opening of the lid, heat-resistant handles (delivery without rack, ladle)

acabado pulido brillante, cubeta sopa inox, platillo a colgar para el cucharón, fondo difusor sandwich, apto para inducción, tapa con apertura controlada, asas frías (cucharón no incluido)

poli brillant, récipient à soupe inox, repose-couvert à accrocher, fond diffuseur sandwich, apte pour induction, couvercle à ouverture contrôlée, anses froides (cadre, louche non incluse)

	Ø cm	↑ cm	ltr.
12399	48	32	10

**Gestell inkl. Brenner / frame incl. burner / soporte incluyendo quemador / support, brûleur inclus**

12396

**Speisenbehälter / foodpan / cubeta superior / bac supérieur**

12397





Chafing Dish „GLOBE“



hochglanzpoliert, mit abnehmbarem hydraulischen Edelstahl-Deckel, Sandwichboden sorgt für optimale Wärmeleitung, für Induktionsplatten geeignet

Set: Gestell + Wasserbecken + Speisenbehälter rund + Löffelablage + Brennpastenbehälter + Metallrahmen für Induktionskochplatte

mirror polished finish, removable hydraulic cover, sandwich base, optimum heat distribution set: frame + waterpan + foodpan round + cutlery compartment ladles + burner holder + frame for induction plate

pulido brillante, con tapa hidráulica extraíble, fondo difusor sandwich apto para inducción. Incluye: 1 pie, 1 cubeta baño maría, 1 cubeta redonda, 1 soporte para cuchara (sin cuchara), 1 quemador, marco inox para la placa de inducción

brillant, couvercle hydraulique amovible, fond diffuseur sandwich apte pour induction. Comprend: pied, cuve bain-marie, bac inox rond, porte-louche (louche non incluse), 1 brûleur, cadre inox pour la plaque à induction

	Ø cm	↑ cm	ltr.	
12393	38,5	34	6	mit Edelstahldeckel with stainless cover
12403	38,5	34	6	mit Glasdeckel with glass cover

Induktionskochplatte für Chafing Dish / induction plate for chafing dish / placa de inducción para chafing dish / plaque à induction pour chafing dish

12295

Metallrahmen für Induktionskochplatten / frame for induction plate / marco para placa de inducción / cadre support inox pour plaque induction

12291

Speiseneinsatz / foodpan / cubeta / bac supérieur

12366



Porzellan-Einsatz

porcelain insert  
bandeja de porcelana  
bac supérieur en porcelaine



	Ø cm	↑ cm	ltr.	fits to
82210	39	6	4,3	12393, 12403
82215	39	6	4,0	12393, 12403



GN 2/3 Chafing Dish „GLOBE“



hochglanzpoliert, mit abnehmbarem hydraulischem Edelstahl-Deckel, Sandwichboden sorgt für optimale Wärmeleitung, für Induktionsplatten geeignet, Set: Gestell + Wasserbecken + 1 GN 2/3 Behälter 65 mm tief + Löffelablage + 1 Brennpastenbehälter + 1 Metallrahmen für Induktionskochplatte

mirror polished finish, removable hydraulic cover, sandwich base, optimum heat distribution, set: frame + waterpan + foodpan GN 2/3, 65 mm, 5,5 l + compartment for ladles + burner holder + frame for induction plate

pulido brillante, con tapa hidráulica extraíble, fondo difusor sandwich apto para inducción. Incluye: 1 pie, 1 cubeta baño maría, 1 cubeta GN 2/3 65 mm - 5,5 l, 1 soporte para cuchara (sin cuchara), 1 quemador, marco inox para la placa de inducción

poli brillant, couvercle hydraulique amovible, fond diffuseur sandwich apte pour induction. Comprend: pied, cuve bain-marie, bac inox GN 2/3-65 mm - 5,5 L, porte-louche (louche non incluse), brûleur, cadre inox pour la plaque à induction

	cm	↑ cm	ltr.	
12483	44 x 41	34	5,5	mit Edelstahl-Deckel with stainless steel cover
12484	44 x 41	34	5,5	mit Glasdeckel with glass cover



Rolltop-Chafing Dish „MAESTRO“



Speisenbehälter GN1/1 65 mm tief (passend auch für 100 mm) + Rolltop-Deckel 90° + Wasserbecken inkl. Vorrichtung für Heizplatte + 2 Brennpastenbehälter

foodpan GN1/1 65 mm (also for 100 mm) + rolltop cover 90° + waterpan with screws for heating unit + 2 burner holders

cubeta GN 1/1 - 65 mm (hay espacio para una cubeta 100 mm) + campana rolltop abatible a 90° + 2 quemadores

bac GN 1/1 - 65 mm (accepte aussi bac ht. 100 mm) + couvercle rolltop ouverture 90° + 2 brûleurs

	cm	↑ cm	ltr.
12300	67 x 35	45	9



Rolltop-Chafing Dish „ELITE“

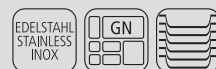

poliert, Rolltop-Deckel klappbar auf 90° und 180°, Speisenbehälter GN 1/1 65 mm tief + Wasserbecken + 2 Brennpastenbehälter, wechseln des GN-Behälters ohne Abnehmen des Deckels (kein Kondenswasser-Rücklaufsystem)

polished, rolltop cover adjustable at 90° and 180°, foodpan GN 1/1 65 mm deep + waterpan + 2 burner holders, change of the GN container without removing the lid (condensed water can not be led back into the waterpan)

pulido brillante, tapa rolltop a 90° o 180°, cubeta GN 1/1 + 2 quemadores, cuba baño maría, se puede cambiar la cubeta GN sin retirar la tapa, importante: el agua condensada no revierte en los alimentos

poli brillant, couvercle rolltop ouverture de 90 a 180°, bac GN 1/1, bain-marie, 2 brûleurs, le bac GN peut être retiré et remplacé sans démonter le couvercle, important: la condensation ne retombe pas sur les aliments

	cm	↑ cm	ltr.
12350	67 x 47	45	9

Wasserbecken inkl. Vorrichtung für Heizelement / waterpan / baño maría / bain-marie

12249



inkl. Vorrichtung für Heizelement  
incl. screws for heating unit



inkl. Vorrichtung für Heizelement  
incl. screws  
for heating unit

Rolltop-Chafing Dish „CATERER“



Speisenbehälter GN 1/1 65 mm tief + Rolltop-Deckel 90° + Wasserbecken inkl. Vorrichtung für Heizplatte + 2 Brennpastenbehälter (Lieferung ohne Heizplatte), massiver Ständer  
foodpan GN 1/1 65 mm deep + rolltop cover 90° + waterpan with screws for heatingunit + 2 burner holders (without heating unit), stable frame  
1 cubeta GN 1/1 - 65 mm + campana rolltop abatible a 90° + 2 quemadores + cuba baño maría con fijaciones para resistencia amovible (se sirve sin la resistencia)  
1 bac GN 1/1 - 65 mm + couvercle rolltop ouverture 90° + 2 brûleurs + 1 bac bain-marie avec 4 vis pour fixation résistance de chauffe amovible (non include)

	cm	↑ cm	ltr.
12245	67 x 35	45	9

Wasserbecken inkl. Vorrichtung für Heizelement / waterpan / baño maría / bain-marie

12249			
-------	--	--	--



Chafing Dish „CATERER PRO“



Deckel hochglanzpoliert, Deckelgriffe hitzebeständig + 2 Brennpastenbehälter + Wasserbecken, inkl. Vorrichtung für Heizplatte + Gestell mit Deckelhalterung (ohne GN Speisenbehälter)  
cover mirror polished finish, cover knob heat-resistant + 2 burner holders + waterpan with screws for heating unit + frame with coverholder (without GN foodpan)  
tapa pulido brillante, asas frías + 2 quemadores + cuba inferior con tornillos para resistencia removable (no incluida) + tapa y estructura con sujeción de la tapa (se sirve sin la cubeta GN)  
couvercle poli brillant, anses froides + 2 brûleurs + bac bain-marie avec fixations pour résistance amovible (non include)

	cm	↑ cm
12233	64 x 35	34

Ersatzdeckel / replacement cover / tapa de recambio / couvercle de rechange

12236		
-------	--	--

Wasserbecken inkl. Vorrichtung für Heizelement / waterpan / baño maría / bain-marie

12249		
-------	--	--



Chafing Dish „CHEF“



Speisenbehälter GN 1/1 65 mm tief + 2 Brennpastenbehälter + Wasserbecken + Deckel + Gestell mit Deckelhalterung + langer Hohlgriff  
foodpan GN 1/1 65 mm + 2 burner holders + waterpan + cove + frame with coverholder  
1 cubeta GN 1/1 65 mm + 2 quemadores + cubeta para el agua + tapa y chasis con bloqueo para la tapa  
1 bac GN 1/1 - 65 mm + 2 brûleurs + 1 bac bain-marie + couvercle + chasis avec blocage couvercle + poignée tube creux

	cm	↑ cm	ltr.
11675	61 x 31	30	9





Die Induktionsstation mit Regler präsentiert sich in einem Set aus Walnussholz, einem schwarzen Metallständer und einer Induktionsheizung.

The induction station with controller is presented in a set of walnut wood, a black metal stand and an induction heater.

La estación de inducción con regulador se presenta en un set formado por una caja de madera de nogal, un soporte de metal negro y un calentador de inducción.

La station à induction avec température réglable se compose d'un caisson en bois noyer, d'un support métallique noir et d'une plaque à induction.



**Induktionsstation, 4-tlg. Set**

induction station, 4 pcs.  
estación de inducción, set de 4  
station d'induction, set de 4



**4 teiliges Set:**

- 1 Induktionskochplatte mit Regler (Ø 24 cm, 900 Watt)
- 1 Metallständer schwarz
- 1 Rahmen aus Walnussholz geölt
- 1 Edelstahlrahmen

**4 pcs. set:**

- 1 induction hotplate with controller (Ø 24 cm, 900 Watt)
- 1 metal stand black
- 1 frame in oiled walnut wood
- 1 stainless steel frame

**set de 4:**

- 1 placa de inducción con regulador (Ø 24 cm, 900 vatios)
- 1 soporte de metal negro
- 1 caja de madera de nogal aceitada
- 1 marco de acero inoxidable

**set de 4:**

- 1 plaque d'induction avec température réglable (Ø 24 cm, 900 watts)
- 1 support métallique noir
- 1 caisson en bois noyer huilé
- 1 cadre en acier inox

	cm	↑ cm
12270	35,4 x 32,5	19



passendes Chafing Dish Set 12330  
suitable chafing dish set 12330

**Ersatzteile / replacement parts / piezas de repuesto / pièces de rechange**

	cm	↑ cm	
12271	35,4 x 32,5	8,5	Holzrahmen / wooden frame
12272	29,5 x 26,5	1	Edelstahlrahmen / stainless steel frame
12295	Ø 24	-	900 Watt Induktionskochplatte / induction plate
15506	35,4 x 32,5	17,6	Buffetständer schwarz / buffet stand black

NEW

4 tlg.  
4 pcs.



12330



12335



12336



12337



12338



12329

4 ltr.

Chafing Dish, 4-teiliges Set

chafing dish set, 4 pcs.  
chafing dish, set de 4  
chafing dish, set de 4



4-teiliges Set:

- 1 Topf (8 Liter)
- 1 Speisenbehälter (4 Liter)
- 1 Deckel mit Sichtfenster und 1 Deckelbremse,
- Topf mit induktionsfähigem Sandwich- / Kapselboden

4 pcs. set:

- 1 pot (8 litres),
- 1 foodpan (4 litres)
- 1 lid with glass insert and 1 automatic lid brake
- pot with induction-compatible sandwich base

set de 4:

- 1 olla (8 litros)
- 1 cubeta (4 litros)
- 1 tapa con ventanilla y 1 sistema de freno en la tapa
- olla con base sandwich apta para inducción

set de 4:

- 1 casserole (8 litres)
- 1 bac (4 litres)
- 1 couvercle avec fenêtre et 1 système de frein dans le couvercle
- casserole avec fond sandwich pour induction

	Ø cm	↑ cm	ltr.	Farbe / Colour	
12330	30,5	17,5	4		stainless
12335	30,5	17,5	4		copper
12336	30,5	17,5	4		yellow
12337	30,5	17,5	4		red
12338 <small>NEW</small>	30,5	17,5	4		black



12336

abnehmbarer Deckel  
removable lid



induktionsgeeignet  
suitable for induction

Ersatz-Speisenbehälter zu Chafing Dish / replacement foodpan for chafing dish / cubeta interior de repuesto para chafing dish / bac intérieur de remplacement pour le chafing dish

	Ø cm	↑ cm	ltr.	fits to
12329	30,5	8	4	12330, 12335, 12336, 12337, 12338



Ø 33 cm

8 ltr. Topf  
8 ltr. pot



Sandwich- / Kapsel-  
boden / sandwich base



Ø 30,5 cm

4 ltr. Speisenbehälter  
4 ltr. foodpan



Deckelbremse  
automatic lid break



GN 1/1 100 mm  
14 ltr.

**Elektro-Rolltop-Chafing Dish „ELITE“**

electric rolltop chafing dish  
chafing dish eléctrico rolltop  
chafing dish électrique rolltop



poliert, Rolltop-Deckel klappbar auf 90° und 180°, Elektro-Wasserbecken mit Temperaturregelung + Speisenbehälter GN 1/1 100 mm tief, 220 - 240 V ~ 50 Hz; 760 - 900 W (kein Kondenswasser-Rücklaufsystem)

polished, rolltop cover adjustable at 90° and 180°, electric waterpan with adjustable heatcontrol + foodpan GN 1/1 100 mm deep, voltage 220 - 240 V ~ 50 Hz, power consumption 760 - 900 W (condensed water cannot be led back into the waterpan)

pulido brillante, tapa abatible apertura a 90° o 180°, baño maría c/ termostato + cubeta GN 1/1 - 100 mm, 220-240 V-50 Hz. Consumo 760-900 W (el agua condensada no gotea dentro de la cubeta)

poli brillant, couvercle rolltop ouverture à 90° ou 180°, bain-marie électrique avec thermostat + bac GN 1/1-100 mm, 220-240 V - 50 Hz; 760-900 W (Important: la condensation ne retombe pas sur les aliments)

	cm	↑ cm	ltr.
12360	67 x 47	45	14



hot price

**Elektrischer Suppentopf „ECONOMIC“**

electric soup warmer  
marmita de sopa eléctrica  
marmite à soupe électrique



Stahl schwarz lackiert, herausnehmbarer Einsatz aus Edelstahl, Temperaturregelung 30°C - 90°C, dreh- und klappbarer Edelstahl-Deckel, inkl. 8 magnetisch haftenden Beschriftungen, 400 W / 230 V

metal, black, removable soup pot, thermostat 30°C - 90°C, st. steel lid, incl. 8 magnetic signs, 400 W / 230 V

metal negro, recipiente sopa inox extraíble, termostato 30°C- 90°C, tapa inox, incluye 8 letreros magnéticos, 400 W / 230 V

acier, noir, récipient à soupe inox amovible, thermostat 30°C - 90°C, couvercle inox, 8 étiquettes magnétiques, 400 W / 230 V

	Ø cm	↑ cm	ltr.
11915	32	36	9

Speisenbehälter / foodpan / recipiente sopa / récipient à soupe

11916

Deckel / cover / tapa / couvercle

11917



**Elektro Chafing Dish**

electric chafing dish  
chafing dish eléctrico  
chafing dish électrique



Speisenbehälter GN 1/1 100 mm tief, Deckelhalter, Thermostat-Regelung 900 W, 230 V

foodpan GN 1/1 100 mm deep, lid holder, thermostat control 900 W, 230 V

cubeta GN 1/1-100 mm, sujeción de la tapa, termostato, 900W, 230 V

bac GN 1/1-100 mm, blocage du couvercle, thermostat, 900W, 230 V

	cm	↑ cm	ltr.
12225	63 x 36	29	14

Deckel / cover / tapa / couvercle

12235





**Elektro-Chafing Dish „ECO“**

electric chafing dish  
chafing dish eléctrico  
chafing dish électrique



Deckel poliert, Elektro-Wasserbecken mit Temperaturregelung + Speisenbehälter GN 1/1 65 mm tief, 220 - 240 V ~ 50 Hz; 760 - 900 W

cover polished, electric waterpan with adjustable heatcontrol + foodpan GN 1/1 65 mm deep, voltage 220 - 240 V ~ 50 Hz, power consumption 760 - 900 W

tapa pulido brillante, baño maría c/ termostato + cubeta GN 1/1 - 65 mm - 220-240 V-50 Hz. / 760-900 W

couvercle poli brillant, bain-marie électrique avec thermostat + bac GN 1/1-65 mm, 220-240 V - 50 Hz; 760-900 W

	cm	↑ cm	ltr.
12232	63 x 36	29	9



**Elektrischer Suppentopf**

electric soup warmer  
marmita de sopa eléctrica  
marmite à soupe électrique



herausnehmbarer Einsatz aus Edelstahl, elektrisch, mit Wasserbad + Löffel + integrierter Tragering für den Innenbehälter, Deckel mit hitzeisolierendem Griff, Temperaturregelung 80°C (± 10°C), 450-550 W, 230 V

removable soup st. steel pan, bain marie electric, ladle, circular frame, thermostat control till 80°C (± 10°C), 450-550 W, 230 V

recipiente sopa inox extraíble, baño maría eléctrico + cucharón + aro inox, tapa con asas frías, termostato hasta 80°C precisión (± 10°C), 450-550 W, 230 V

réipient à soupe inox amovible, bain-marie électrique, louche, support circulaire inox, thermostat maxi 80°C (± 10°C), 450-550 W, 230 V

	Ø cm	↑ cm	ltr.
11901	38	36,5	10



**Elektrischer Suppentopf**

electric soup warmer  
marmita de sopa eléctrica  
marmite à soupe électrique



herausnehmbarer Einsatz aus Edelstahl, elektrisch, mit Wasserbad + Löffel + integrierter Tragering für den Innenbehälter, Deckel mit hitzeisolierendem Griff, Temperaturregelung 80°C (± 10°C), 400 - 450 W / 220 - 240 V

removable soup st. steel pan, bain marie electric, ladle, st. steel circular frame, thermostat control till 80°C (± 10°C), 400 - 450 W / 220 - 240 V

recipiente sopa inox extraíble, baño maría eléctrico + cucharón + aro inox, tapa con asas frías, termostato hasta 80°C precisión (±10°C), 400 - 450 W / 220 - 240 V

réipient à soupe inox amovible, bain-marie électrique, louche, support circulaire inox, thermostat maxi 80°C (± 10°C), 400 - 450 W / 220 - 240 V

	Ø cm	↑ cm	ltr.
11910	40	37	10

Edelstahlgefäß / stainless steel pan / recipiente sopa inox / réipient à soupe inox

11911

Edelstahl-Deckel / stainless steel lid / tapa inox / couvercle inox

11912

Elektrokabel / electric cable / cable eléctrico / cable électrique

11913



**Fondue und Feuerzangenbowl-Set „TWO IN ONE“**

fondue and fire punch bowl set  
set para fondue o ponche caliente  
service à fondue et à punch



13-teiliges Set aus Edelstahl bestehend aus:  
1 Topf, 1 Rechaud, 1 Spritzschutz, 1 Untersetzer, 1 Schöpfkelle, 1 Feuerzange,  
1 Pastenbrenner, 6 Fonduegabeln

13-piece stainless steel set consisting of:  
1 pot, 1 rechaud, 1 splash guard, 1 coaster, 1 ladle, 1 fire tongs,  
1 paste burner, 6 fondue forks

set de 13 piezas de acero inoxidable compuesto por:  
1 olla, 1 rechaud, 1 protector contra salpicaduras, 1 trébede, 1 cazo,  
1 pinza para el fuego, 1 quemador de pasta, 6 tenedores de fondue

set de 13 pièces en acier inox comprenant:  
1 marmite, 1 rechaud, 1 pare-éclaboussures, 1 dessous de plat, 1 louche, 1 pince à feu,  
1 brûleur à pâte, 6 fourchettes à fondue

	Ø cm	↑ cm	ltr.
65060	22	23	2,2



**Brennpastenbehälter zu 65060 / fuel paste container for 65060 / recipiente para pasta de combustible para 65060 / récipient pour pâte à combustible pour 65060**



	cm	↑ cm	fits to
65061	26 x 12	10	65060



**Gabelset zu 65060 / fork set for 65060 / set de tenedores para 65060 / set de fourchettes pour 65060**



	cm	→ cm	pcs.	fits to
65062	24	Griff / handle 8	6	65060



### Kaffeedispenser „HAPPY HOUR“

coffee dispenser  
dispensador de café  
distributeur de café



hochglanzpoliert, für warme Getränke, stabil und standfest, inkl. 1 Brennpastenbehälter  
mirror polished finish, for warm drinks, solid and stable, incl. 1 burner holder  
acabado pulido brillante para bebidas calientes, sólido y estable, incluye un calentador  
brillant, pour boissons chaudes, avec 1 brûleur, robuste et stable

	cm	↑ cm	ltr.
11672	31 x 33,5	54,5	10,5

Hahn / tap / grifo / robinet

11671

Elektro-Heizelement / heating unit / resistencia / résistance

	cm	↑ cm
12287	21 x 20	6



### Rolltophaube „SWISS“

rolltop-cover  
campana rolltop  
cloche rolltop



hochglanzpoliert, klappbar auf 90°, nachrüstbar für alle handelsüblichen Chafer  
mirror polished finish, cover adjustable at 90°, usable for all commercial chafing dishes  
pulido brillante, tapa ajustable 90°, apto para todos los chafings profesionales  
poli brillant, ouverture réglable à 90°, apte pour tous les chafings professionnels

	cm	↑ cm
12310	55 x 34	19,5



### Bain-Marie Topf

bain marie pot  
olla baño Maria  
marmite bain-marie



inkl. Deckel, mit Löffelaussparung  
included cover, notched for spoon  
incluye tapa con hueco para la cuchara  
inclut le couvercle avec espace pour la louche

	Ø cm	↑ cm	ltr.
12244	20	18	4,5

Deckel / cover / tapa / couvercle

11244



### Bain-Marie Deckel

cover for bain marie  
tapa del baño maria  
couvercle du bain-marie



	cm
12243	54 x 33,5





**Einbau-Induktionskochplatte für Chafing Dish**

built-in induction plate for chafing dish  
placa de inducción para empotrar  
plaque à induction à encastrer

inkl. Kabel-Fernbedienung, energiesparend, Leistung in 5 Stufen regelbar, integrierte Lüftung, sehr leise im Betrieb

incl. cable remote control, energy-saving, power adjustable in 5 steps, integrated ventilation, very quiet in operation

incl. mando a distancia con cable, ahorro energético, potencia regulable en 5 pasos, ventilación integrada, funcionamiento silencioso

y compris télécommande filaire, économe en énergie, puissance réglable en 5 étapes, ventilation intégrée, très silencieux en fonctionnement

	cm	↑ cm	
12285	35,5 x 35,5	6	2000 W



**Induktionskochplatte für Chafing Dish**

induction plate for chafing dish  
placa de inducción para chafing dish  
plaque à induction pour chafing dish

mit Regler

with power control

con control de potencia

avec régulateur

	Ø cm	
12295	24	900 W



**Metallrahmen für Induktionskochplatten**

frame for induction plate  
marco para placa de inducción  
cadre support inox pour plaque induction



12291	für runde Chafer / for round chafing dish
12296	für Chafer GN 1/1 / for GN 1/1 chafing dish



**Elektro-Heizelement**

heating unit  
resistencia  
résistance



für Kaffeedispenser (Nr. 11672), 500 W, 220 V, einfach in das Gestell des Dispensers legen  
for coffee dispenser (no. 11672), 500 W, 220 V, insert into the frame of the dispenser  
para dispensador de café (11672), 500 W, 220V, directamente en el pie del dispensador  
pour distributeur à café (11672), 500 W, 220 V, directement dans le support

12287	500 W / 220 V
-------	---------------



Heizplatte durch Spiralfeder an Wasserbad gedrückt  
Heating plate is pressed against the water bath by a spiral spring

**Mobile Chafing Dish Heizung**

heating element  
resistencia  
résistance



für alle marktgängigen Chafing Dishes / suitable for all current popular chafing dishes, with special spring / para todos los chafing dish más corrientes / pour la plupart des chafing dish les plus courants

	Ø cm	↑ cm	
12299	14	9 - 11	500 W / 220 V

# CHAFING DISH · GN CONTAINER · TRANSPORT

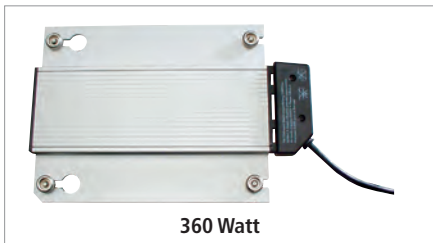

## Elektro-Heizelement

heating unit  
resistencia  
résistance



for chafer covers are closed most of the time

12290

360 W / 140 - 250 V

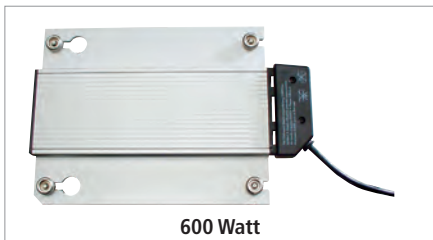

## Elektro-Heizelement

heating unit  
resistencia  
résistance



for chafer covers are open most of the time

12292

600 W / 230 V

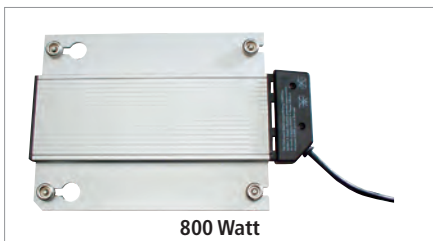

## Elektro-Heizelement

heating unit  
resistencia  
résistance



for chafer covers are open most of the time

12294

800 W / 230 V



## Brennpastenbehälter

burner holder  
quemador  
brûleur



mit Bajonettverschluss / bayonet lock / cierre de bayoneta/ verrouillage par baïonnette

11683

Ø cm

↑ cm

9

6



## Speisenwärmer „PROFI“

plate warmer  
calienta platos  
chauffe-plat



35050

cm

↑ cm

33 x 18

7

2 Teelichter / 2 tealights / 2 velas / 2 bougies



## Speisenwärmer

warmer  
calienta platos  
chauffe-plat



3-flammig / 3 lights / 3 velas / 3 bougies

35065

cm

↑ cm

34 x 18

6



## Speisenwärmer

warmer  
calienta platos  
chauffe-plat



2-flammig / 2 lights / 2 velas / 2 bougies

35343

cm

↑ cm

34 x 13

6



**Wärme-Kies**

granite chips  
granulado térmico  
gravier thermique



für Chafing Dishes, feine Körnung, hohe Wärmespeicherung, kein Verkleben,  
ideal zum Warmhalten von Eiern

fine for chafing dishes and clean granite chippings, ideal for keeping eggs warm

gravilla de granito fina limpia, ideal para mantener los huevos calientes

gravier fin de granit, lavé, idéal pour maintenir les oeufs au chaud



81116

7



**Besteckablage**

cutlery rest  
reposa cuchara  
pose-cuillère



cm                      ↑ cm

00650

27 x 11

3,5



**Besteckablage „SPOON“**

cutlery rest  
reposa cuchara  
pose-cuillère



cm                      ↑ cm

83801

26 x 10,5

5



**Besteckablage „BOWL“**

cutlery rest  
reposa cuchara  
pose-cuillère



cm                      ↑ cm                      ltr.

83803

22,5 x 11

6

0,5



**Besteckablage „SMALL WAVE“**

cutlery rest  
reposa cuchara  
pose-cuillère



cm                      ↑ cm

83897

26 x 13

4,5



# CHAFING DISH · GN CONTAINER · TRANSPORT



## GN-Behälter „INDU“

GN container  
GN cubeta  
GN bac



### Behälter mit Keramik-Beschichtung, konstanter Antihaft-Effekt

container with ceramic coating, constant non-stick effect

cubeta con revestimiento cerámico, efecto antiadherente constante

bac avec revêtement céramique, effet anti-adhérent constant

	GN	cm	↑ cm	litr.	Farbe / Colour
88200	1/1	53,0 x 32,5	7,5	7,5	White
88201	1/2	32,5 x 26,5	7,5	3,0	White
88202	2/3	35,4 x 32,5	7,5	4,5	White
88205	1/1	53,0 x 32,5	7,5	7,5	Black
88206	1/2	32,5 x 26,5	7,5	3,0	Black
88207	2/3	35,4 x 32,5	7,5	4,5	Black
88209	1/1	53,0 x 32,5	7,5	7,5	Blue
88210	1/2	32,5 x 26,5	7,5	3,0	Blue
88211	2/3	35,4 x 32,5	7,5	4,5	Blue

		Ø cm	↑ cm	litr.	Farbe / Colour
88204	-	38,5	7,5	6,5	White
88208	-	38,5	7,5	6,5	Black
88212	-	38,5	7,5	6,5	Blue

### Hinweis / Note / Remarque / Nota

Antihafbeschichtung ist nicht schnittfest. Keine scharfen oder spitzen Küchenhelfer verwenden. Ideal ist der Gebrauch von Küchenhelfer aus Holz oder Kunststoff.

Non-stick coating is not cut resistant. Do not use sharp or pointed kitchen utensils. Ideal is the use of kitchen helpers made of wood or plastic.

Le revêtement anti-adhésif n'est pas résistant aux coupures. N'utilisez pas d'ustensiles de cuisine tranchants ou pointus. L'idéal est d'utiliser des aides de cuisine en bois ou en plastique.

El recubrimiento antiadherente no es resistente al corte. No utilice utensilios de cocina afilados o puntiagudos. Lo ideal es el uso de utensilios de cocina de madera o plástico.



**GN-Behälter Größen nach EN 631**

Alle Behälter sind aus rostfreiem Chrom-Nickel-Edelstahl mit elektrolytisch polierter (seidenmatt) Oberfläche und somit perfekt geeignet für den professionellen Einsatz.

**GN-container according to EN 631**

All pans are made of chrome/nickel stainless steel with a surface polished by electrolysis (satin-matt) and therefore highly suitable for professional operation.

**De conformidad con la norma europea EN 631.**

Todos los contenedores están fabricados en acero inoxidable cromado/niquelado con su superficie (satinada) pulida por electrolisis lo que la hace altamente apropiado para el uso profesional.

**Bacs GN- Conforme à la norme EN 631**

Tous les bacs sont fabriqués en inox/chrome/nickel, surface polie électrolythique (satiné). Approprié pour usage professionnel.

**Vorteile der rund geprägten U-Ecken:**

- erhöhte Stabilität durch verstärktes Profil
- zielgerechtes und sauberes Ausgießen
- genaue Positionierung der GN-Behälter
- superleichtes Stapeln und Entstapeln
- kein Verklemmen der GN-Behälter
- hohe Stoßfestigkeit durch robuste Konstruktion
- ansprechendes Design und stilvoller Blickfang

**Advantages of the round-shaped U-Corners:**

- increased stability due to the unique construction
- clean lading and pouring
- exact positioning of the containers
- improved shock-resistance
- appealing design
- no seize of the containers

**Ventajas de las esquinas en U:**

Perfil reforzado que confiere mayor rigidez y resistencia a la cubeta, diseño para verter fácil y limpiamente, fáciles de apilar y desapilar sin que se claven entre sí, construcción más robusta y resistente a los golpes mecánicos, diseño elegante.

**Avantages et fonctionnalité des angles en U:**

Profil renforcé pour une meilleure consistance et rigidité du récipient, design qui facilite un versage propre et aisé, permet un empilage et désempliage faciles sans que les bacs restent coincés, meilleure résistance aux chocs mécaniques, seign élégant.

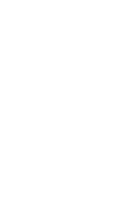
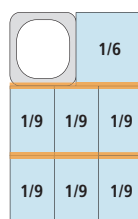
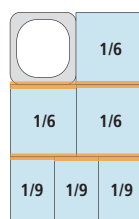
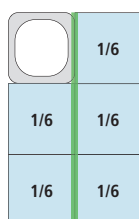
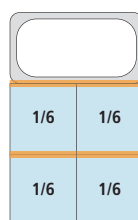
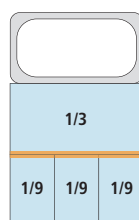
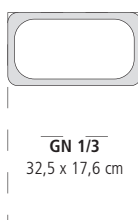
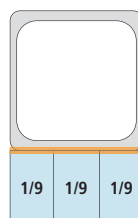
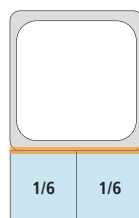
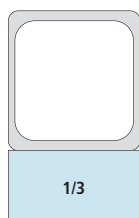
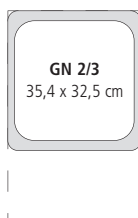
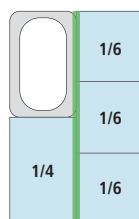
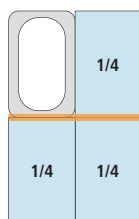
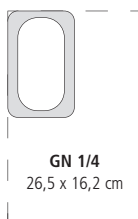
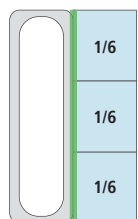
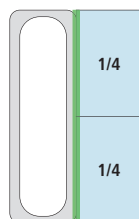
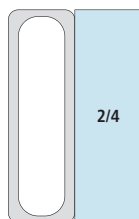
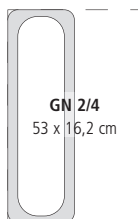
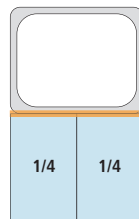
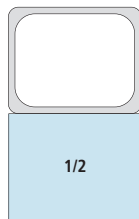
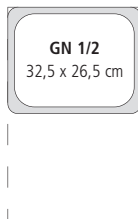
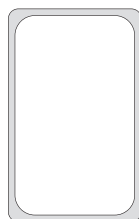

# CHAFING DISH · GN CONTAINER · TRANSPORT



## GN-Behälter

GN-container

GN cubetas

GN bacs



	GN	↓ mm	ltr.	cm
81000	2/1	20	5,0	53,0 x 65,0
81095	1/1	10	1,25	53,0 x 32,5
81100	1/1	20	2,5	53,0 x 32,5
81101	1/1	40	5,0	53,0 x 32,5
81109	1/1	55	6,5	53,0 x 32,5
81102	1/1	65	9,0	53,0 x 32,5
81104	1/1	100	13,25	53,0 x 32,5
81106	1/1	150	20,0	53,0 x 32,5
81108	1/1	200	25,0	53,0 x 32,5
-----				
	GN	↓ mm	ltr.	cm
81200	1/2	20	1,0	32,5 x 26,5
81201	1/2	40	2,0	32,5 x 26,5
81209	1/2	55	2,8	32,5 x 26,5
81202	1/2	65	4,0	32,5 x 26,5
81204	1/2	100	6,0	32,5 x 26,5
81206	1/2	150	8,75	32,5 x 26,5
81208	1/2	200	11,65	32,5 x 26,5
-----				
	GN	↓ mm	ltr.	cm
81300	1/3	20	0,75	32,5 x 17,6
81302	1/3	65	2,5	32,5 x 17,6
81304	1/3	100	4,0	32,5 x 17,6
81306	1/3	150	5,7	32,5 x 17,6
81308	1/3	200	7,0	32,5 x 17,6
-----				
	GN	↓ mm	ltr.	cm
81400	1/4	20	0,5	26,5 x 16,2
81401	1/4	40	1,0	26,5 x 16,2
81402	1/4	65	1,8	26,5 x 16,2
81404	1/4	100	2,8	26,5 x 16,2
81406	1/4	150	4,0	26,5 x 16,2
81408	1/4	200	5,5	26,5 x 16,2
-----				
	GN	↓ mm	ltr.	cm
81602	1/6	65	1,0	17,6 x 16,2
81604	1/6	100	1,6	17,6 x 16,2
81606	1/6	150	2,4	17,6 x 16,2
81608	1/6	200	3,0	17,6 x 16,2
-----				
	GN	↓ mm	ltr.	cm
81502	1/9	65	0,6	17,6 x 10,8
81504	1/9	100	1,0	17,6 x 10,8
81506	1/9	150	1,5	17,6 x 10,8
-----				
	GN	↓ mm	ltr.	cm
81700	2/3	20	1,5	35,4 x 32,5
81701	2/3	40	3,0	35,4 x 32,5
81702	2/3	65	5,5	35,4 x 32,5
81704	2/3	100	8,4	35,4 x 32,5
81706	2/3	150	12,5	35,4 x 32,5
81707	2/3	200	18,0	35,4 x 32,5
-----				
	GN	↓ mm	ltr.	cm
81800	2/4	20	1,2	53,0 x 16,2
81801	2/4	40	2,4	53,0 x 16,2
81802	2/4	65	3,6	53,0 x 16,2
81804	2/4	100	5,6	53,0 x 16,2
81806	2/4	150	8,7	53,0 x 16,2



**perforierte GN-Behälter**

perforated GN-container  
cubetas GN perforadas  
bacs GN perforés



	GN	↓ mm	cm
81911	1/1	40	53,0 x 32,5
81907	1/1	65	53,0 x 32,5
81908	1/1	100	53,0 x 32,5
81909	1/1	150	53,0 x 32,5
81910	1/1	200	53,0 x 32,5
81901	1/2	65	32,5 x 26,5
81902	1/2	100	32,5 x 26,5
81903	1/2	150	32,5 x 26,5
81904	1/2	200	32,5 x 26,5
81905	2/3	65	35,4 x 32,5
81906	2/3	100	35,4 x 32,5

**NEW**

**2 x GN 1/4**  
26,5 x 16,2 cm

**1 x GN 1/2**  
32,5 x 26,5 cm

**4 ltr.**

**1,8 ltr.**

**1 x Adapter**  
31,5 cm

**GN BEHÄLTER-SET**  
4-TEILIG - 65 MM TIEF

**Lieferung in Farbverpackung**  
delivery in colour packaging

**GN-Behälter Set, 4 teilig**

GN-container, 4 pcs.  
GN cubetas, set de 4  
GN bacs, set de 4



bestehend aus: Edelstahlbehälter 1x GN 1/2 + 2x GN 1/4 + 1 Adapter

consisting of: stainless steel containers 1x GN 1/2 + 2x GN 1/4 + adapter

consiste en: cubetas de acero inoxidable 1x GN 1/2 + 2x GN 1/4 + adaptador

composé de: bacs en acier inox 1x GN 1/2 + 2x GN 1/4 + adaptateur

	GN	↓ mm	ltr.	cm	pcs
81850	1/2	65	4	32,5 x 26,5	1
	1/4	65	1,8	26,40 x 16,2	2
	Adapter			31,5	1





**GN-Deckel**

GN-lid  
GN tapa  
GN couvercle



**ohne Löffelaussparung**  
without notched edge for spoons  
sin agujero para cucharón  
sans espace pour louche

	GN	cm
81195	1/1	53,0 x 32,5
81295	1/2	32,5 x 26,5
81395	1/3	32,5 x 17,6
81495	1/4	26,5 x 16,2
81695	1/6	17,6 x 16,2
81591	1/9	17,6 x 10,8
81795	2/3	35,4 x 32,5
81895	2/4	53,0 x 16,2



**GN-Deckel**

GN-lid  
GN tapa  
GN couvercle



**mit Löffelaussparung**  
with notched edge for spoons  
con agujero para cucharón  
avec espace pour louche

	GN	cm
81191	1/1	53,0 x 32,5
81292	1/2	32,5 x 26,5
81391	1/3	32,5 x 17,6
81492	1/4	26,5 x 16,2
81692	1/6	17,6 x 16,2
81595	1/9	17,6 x 10,8
81791	2/3	35,4 x 32,5
81891	2/4	53,0 x 16,2



Die Löffelaussparung mit Prägung verhindert das Zurückfließen von Flüssigkeit auf dem Deckel in den Behälter.  
The notche for spoon with embossing prevents liquid on the lid from flowing back into the container.

schwappsicherer Transport!



80023



80028



80029

nicht für Kombidämpfer geeignet!  
max. 100°C

### GN Transport-Steck-Deckel

GN-lid with silicone seal  
GN tapa hermética con junta  
GN couvercle hermétique avec joint



Silikondichtung, Griffmulde und Loch gegen Unterdruck,  
nicht für Kombidämpfer geeignet

silicone joint, flat handle, vent to compensate  
for pressure, not usable for steam oven

junta de silicona, asa empotrada, válvula para compensar  
la presión, no se puede utilizar en hornos de vapor

joint silicone, anse encastrée, valve pour compenser la pression

	GN	cm
80023	1/1	53,0 x 32,5
80024	1/2	32,5 x 26,5
80025	1/3	32,5 x 17,6
80026	1/4	26,5 x 16,2
80027	1/6	17,6 x 16,2
80028	2/4	53,0 x 16,2
80029	2/3	35,4 x 32,5

### Adapter / Zwischensteg

adapter  
adaptador  
adaptateur



ermöglicht stabilen Halt von GN-Behältern im CD, rostfreier Chrom-Nickel-Edelstahl

for fixing GN pans, chrome / nickel stainless steel

para sujetar las cubetas GN, acero inox

support stable pour les bacs GN

	cm	
81996	15,9	längs bei GN 1/4 / lengthwise GN 1/4 longitud GN 1/4 / GN 1/4 dans la longueur
81997	17,6	längs bei GN 1/9 / lengthwise GN 1/9 longitud GN 1/9 / GN 1/9 dans la longueur
81999	32,5	quer bei GN 1/2 / crosswise GN 1/2 de ancho GN 1/2 / GN 1/2 dans la largeur
81998	53	längs bei GN 1/1 / lengthwise GN 1/1 longitud GN 1/1 / GN 1/1 dans la longueur

### GN Abtropfgitter

GN-drainer  
GN escurridor  
GN égouttoir



Abtropfgitter aus Edelstahl für Gastronorm Behälter, passend für GN 1/1 und GN 1/2

stainless steel GN drainer for GN 1/1 + GN 1/2

escurridor GN de acero inoxidable para GN 1/1 + GN 1/2

égouttoir GN en acier inoxydable pour GN 1/1 + GN 1/2

	GN	cm	↑ cm
81117	1/1	45 x 25	1,5
81118	1/2	25 x 19	1,5



81117



81118

# CHAFING DISH · GN CONTAINER · TRANSPORT



## GN-Behälter aus Polycarbonat

GN-container polycarbonate  
GN cubeta policarbonato  
GN bac polycarbonate

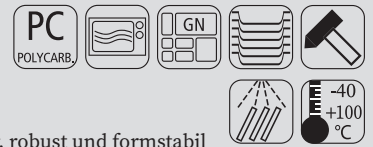

**transparent: Inhalt gut erkennbar, Skalierung in Liter, robust und formstabil**

transparent: content can be seen, liter scale, solid quality

transparente para ver el contenido, graduación en litros, alta calidad

transparent pour voir le contenu, graduation en litres, haute-qualité

	GN	↓ mm	ltr.	cm
82004	1/1	65	8,5	53 x 32,5
82006	1/1	100	13,0	53 x 32,5
82008	1/1	150	19,5	53 x 32,5
82010	1/1	200	26,0	53 x 32,5
	GN	↓ mm	ltr.	cm
82012	1/2	65	3,9	32,5 x 26,5
82014	1/2	100	5,9	32,5 x 26,5
82016	1/2	150	8,9	32,5 x 26,5
82017	1/2	200	11,8	32,5 x 26,5
	GN	↓ mm	ltr.	cm
82018	1/3	65	2,4	32,5 x 17,6
82020	1/3	100	3,6	32,5 x 17,6
82022	1/3	150	5,3	32,5 x 17,6
82023	1/3	200	7,0	32,5 x 17,6
	GN	↓ mm	ltr.	cm
82028	1/4	65	1,7	26,5 x 16,2
82030	1/4	100	2,5	26,5 x 16,2
82032	1/4	150	3,7	26,5 x 16,2
82034	1/4	200	4,8	26,5 x 16,2
	GN	↓ mm	ltr.	cm
82036	1/6	65	1,0	17,6 x 16,2
82038	1/6	100	1,5	17,6 x 16,2
82040	1/6	150	2,2	17,6 x 16,2
82042	1/6	200	2,8	17,6 x 16,2
	GN	↓ mm	ltr.	cm
82050	1/9	65	0,6	17,6 x 10,2
82051	1/9	100	1,0	17,6 x 10,2



## GN-Deckel

GN-lid  
GN tapa  
GN couvercle



	GN	cm
82001	1/1	53,0 x 32,5
82013	1/2	32,5 x 26,5
82019	1/3	32,5 x 17,6
82029	1/4	26,5 x 16,2
82037	1/6	17,6 x 16,2
82059	1/9	17,6 x 10,8



## GN Abtropfgitter

GN drainer  
GN escurridor  
GN égouttoir



	für GN	cm
82003	1/1	47,3 x 26,8
82005	1/2	26,8 x 20,8
82007	1/3	26,8 x 11,8



**GN-Behälter aus Polypropylen**

GN-container polypropylene  
GN cubetas polipropileno  
GN bacs polypropilène

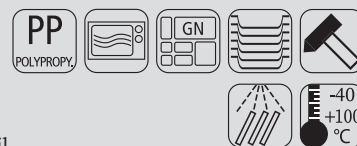

**transparent: Skalierung in Liter, robust und formstabil**

transparent: liter scale, solid quality

transparente: graduación en litros, alta calidad

transparent: graduation en litres, haute-qualité

	GN	↓ mm	ltr.	cm
82104	1/1	65	8,5	53 x 32,5
82106	1/1	100	13,0	53 x 32,5
82108	1/1	150	19,5	53 x 32,5
82110	1/1	200	26,0	53 x 32,5
82112	1/2	65	3,9	32,5 x 26,5
82114	1/2	100	5,9	32,5 x 26,5
82116	1/2	150	8,9	32,5 x 26,5
82117	1/2	200	11,8	32,5 x 26,5
82118	1/3	65	2,4	32,5 x 17,5
82120	1/3	100	3,6	32,5 x 17,5
82122	1/3	150	5,3	32,5 x 17,6
82123	1/3	200	7,0	32,5 x 17,6
82128	1/4	65	1,7	26,5 x 16,2
82130	1/4	100	2,5	26,5 x 16,2
82132	1/4	150	3,7	26,5 x 16,2
82134	1/4	200	4,8	26,5 x 16,2
82136	1/6	65	1,0	17,6 x 16,2
82138	1/6	100	1,5	17,6 x 16,2
82140	1/6	150	2,2	17,6 x 16,2
82142	1/6	200	2,8	17,6 x 16,2
82150	1/9	65	0,6	17,6 x 10,8
82151	1/9	100	1,0	17,6 x 10,8



stapelbar  
stackable



Skalierung  
scaling



**GN-Deckel**

GN-lid  
GN tapa  
GN couvercle

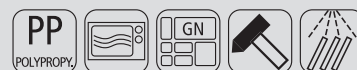

	GN	cm
82101	1/1	53,0 x 32,5
82113	1/2	32,5 x 26,5
82119	1/3	32,5 x 17,6
82129	1/4	26,5 x 16,2
82137	1/6	17,6 x 16,2
82159	1/9	17,6 x 10,8



## CHAFING DISH · GN CONTAINER · TRANSPORT



### GN-Konvektomatenblech

GN-convection oven trays  
GN cubeta para hornos de convección  
GN bac pour fours à convection



**Oberfläche mit schwarzer Antihafbeschichtung, schwere Qualität**

coated black non stick, heavy quality  
interior con revestimiento antiadherente negro, alta calidad  
revêtement intérieur antiadhérent noir, haute qualité

	GN	↓ mm	cm
88246	1/1	20	53 x 32,5



### Backblech

baking sheet  
bandeja pastelera  
plaque à pâtisserie



**gelocht Ø 3 mm, Materialstärke 1,5 mm, Silikon beschichtet, temperaturbeständig bis 240°C**

perforated Ø 3 mm, coated with silicon, heat resistant up to 240°C  
aluminio con revestimiento de silicona perforada, resistente hasta 240°  
aluminium avec revêtement silicone, perforée, température maxi 240°

	GN	cm
88285	1/1	53 x 32,5

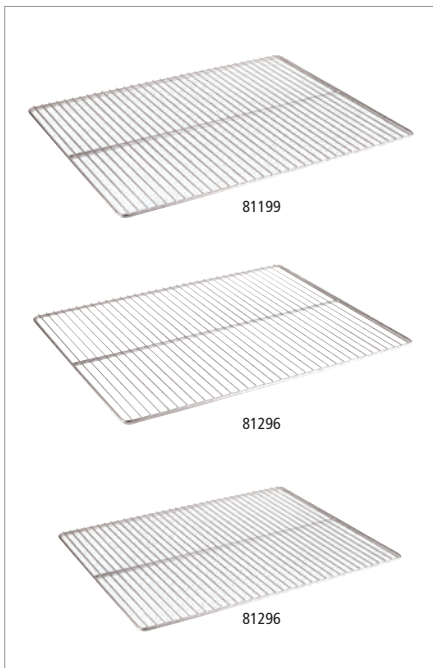

### GN Roste

GN grid  
GN rejilla  
GN grille



**elektrolytisch poliert, Drahtstärke 3 mm, Rahmendraht 6 mm, extra schwere Qualität**

electro-polished, wire thickness 3 mm, frame wire 6 mm, extra heavy quality  
inox pulido electrolítico, grosor alambre 3 mm, grosor marco 6 mm, calidad reforzada  
inox poli électrolytique, fil 3 mm, cadre 6 mm, qualité renforcée

	GN	cm
81199	2/1	65,0 x 53,0
81198	1/1	53,0 x 32,5
81796	2/3	32,5 x 35,4
81296	1/2	32,5 x 26,5



### GN 1/3 Bestecksammler

GN 1/3 container  
GN 1/3 cubeta  
GN 1/3 bac



**mit 2 Haken zum Einhängen an Servier- oder Transportwagen**

container with 2 hooks, to hang on trolleys for cutlery  
cubeta con 2 ganchos para cubiertos, a colgar del carro  
bac à couverts avec 2 crochets, à accrocher au chariot

	GN	↓ mm	cm
11978	1/3	150	32,5 x 17,5



**GN-Behälter**

GN-container  
GN cubetas  
GN bac



	GN	↓ mm	ltr.	cm
82100	1/1	60	7,1	53,0 x 32,5
82200	1/2	60	3,4	32,5 x 26,5
82300	1/3	60	2,0	32,5 x 17,6
82306	2/3	60	4,6	35,4 x 32,5
82301	2/4	60	3,0	53,0 x 16,2



**GN Tablett „FRAMES“**

GN tray  
GN bandeja  
GN plateau



	GN	↑ cm	cm
82355	1/1	2	53,0 x 32,5
82356	1/2	2	32,5 x 26,5
82357	1/3	2	32,5 x 17,6



**GN Tablett**

GN tray  
GN bandeja  
GN plateau



	GN	↑ cm	cm
82201	1/1	2,5	53,0 x 32,5
82202	1/2	2,5	32,5 x 26,5
82203	1/3	2,5	32,5 x 17,6
82204	2/4	2,5	53,0 x 16,2
82205	2/3	2,5	35,4 x 32,5



**GN 1/1 Buffet-Set „CATERER“**

GN 1/1 buffet set  
GN 1/1 set de bufé  
GN 1/1 set catering: plateau + cloche



2-teilig: Tablett + Haube, Tablett fixiert sich auf der Haube - kein Rutschen möglich  
2 pcs. set: tray + cover, tray fixes itself on the cover and can not slip off  
set de 2: bandeja + tapa, la bandeja encaja encima de la tapa para que no se deslice  
set de 2: plateau GN 1/1 réf. + cloche spéciale empilement stable

	cm	↑ cm	GN	fits to
11195	53 x 32,5	10,5	1/1	82201, 82355

# CHAFING DISH · GN CONTAINER · TRANSPORT

hot price



GN 2/4



GN 1/1



GN 1/2



GN 1/4



GN 1/6

## GN-Behälter „ECOLINE“

GN container

GN cubeta

GN bac

mit Stapelnocke

with notching edge

con borde marcado para el apilado

avec rebord pour l'empilage



	GN	↓ mm	ltr.	cm	Farbe / Colour
83759	1/1	65	7,10	53,0 x 32,5	White
83755	2/4	65	3,00	53,0 x 16,2	White
83757	1/2	65	3,40	32,5 x 26,5	White
83753	1/3	65	2,00	32,5 x 17,6	White
83751	1/4	65	1,35	26,5 x 16,2	White
83749	1/6	65	0,80	17,6 x 16,2	White

	GN	↓ mm	ltr.	cm	Farbe / Colour
83758	1/1	65	7,10	53,0 x 32,5	Black
83754	2/4	65	3,00	53,0 x 16,2	Black
83756	1/2	65	3,40	32,5 x 26,5	Black
83752	1/3	65	2,00	32,5 x 17,6	Black
83750	1/4	65	1,35	26,5 x 16,2	Black
83748	1/6	65	0,80	17,6 x 16,2	Black

	GN	↓ mm	ltr.	cm	Farbe / Colour
84300	1/1	100	10,6	53,0 x 32,5	White
84302	2/4	100	4,3	53,0 x 16,2	White
84301	1/2	100	4,7	32,5 x 26,5	White
84303	1/3	100	2,7	32,5 x 17,6	White
84304	1/4	100	1,9	26,5 x 16,2	White
84305	1/6	100	1,0	17,6 x 16,2	White

	GN	↓ mm	ltr.	cm	Farbe / Colour
84306	1/1	100	10,6	53,0 x 32,5	Black
84308	2/4	100	4,3	53,0 x 16,2	Black
84307	1/2	100	4,7	32,5 x 26,5	Black
84309	1/3	100	2,7	32,5 x 17,6	Black
84310	1/4	100	1,9	26,5 x 16,2	Black
84311	1/6	100	1,0	17,6 x 16,2	Black



## GN-Deckel

GN-lid

GN tapa

GN couvercle



	GN	cm
82001	1/1	53,0 x 32,5
82013	1/2	32,5 x 26,5
82019	1/3	32,5 x 17,6
82029	1/4	26,5 x 16,2
82037	1/6	17,6 x 16,2



83762

83763

**GN-Behälter „HIGHLINE“**

GN-container  
GN cubeta  
GN bac



mit Stapelnocke  
with notching edge  
con borde marcado para el apilado  
avec rebord pour l'empilage

	GN	↓ mm	ltr.	cm
83772	1/1	65	7,10	53,0 x 32,5
83770	2/3	65	4,60	35,0 x 32,5
83768	1/2	65	3,40	32,5 x 26,5
83766	2/4	65	3,00	53,0 x 16,2
83764	1/3	65	2,00	32,5 x 17,6
83762	1/4	65	1,35	26,5 x 16,2
83760	1/6	65	0,80	17,6 x 16,2

	GN	↓ mm	ltr.	cm
83773	1/1	100	11,0	53,0 x 32,5
83769	1/2	100	5,50	32,5 x 26,5
83765	1/3	100	3,15	32,5 x 17,6
83763	1/4	100	2,20	26,5 x 16,2
83761	1/6	100	1,25	17,6 x 16,2



83768



11302

GN 1/1, 2-tlg. Set: Tablett + Haube

System-Haube für stapelbare Tablett  
wie 11300, 11290 oder 11295

**GN 1/1 Buffet-Set „HOCHSTAPLER“**

GN 1/1 buffet set  
GN 1/1 set de bufé  
GN 1/1 kit catering plateau + cloche



2-teilig: Tablett + Haube, Tablett fixiert sich auf der Haube - kein Rutschen möglich  
2 pcs. set: tray + cover, tray fixes itself on the cover and can not slip off  
set de 2 piezas: bandeja + tapa, la bandeja encaja encima de la tapa para que no se deslice  
ensemble de 2 pièces: plateau GN 1/1 réf. + cloche spéciale empilement stable

	cm	↑ cm	GN
11302	53 x 32,5	10,5	1/1





Servier- / Transportwagen

serving trolley  
carro de servicio  
chariot de service



Gestell aus Vierkantröhr 25 x 25 mm, Ablagefläche innen 84 x 44,5 cm, Bodenfläche 90 x 50 cm, auf Unterseite schalldämmend beschichtet, Abstand zwischen den Böden 28 cm / 29 cm, mit 4 Lenkrollen Ø 12,5 cm, alle mit Feststellern, Lieferung demontiert, einfache Montage, Tragfähigkeit 33 kg je Boden

frame retangular bar 25 x 25 mm, shelf board inside 84 x 44,5 cm, shelf board outside 90 x 50 cm, undersurface coated sound-damping, distance between the boards 28 cm / 29 cm, with 4 swivel wheels Ø 12,5 cm, all with brakes, unassembled, simple assembly, max load 33 kg per shelf

estructura tubo cuadrado 25 x 25 mm, útiles int. por piso 84 x 44,5 cm. ext. al suelo 90 x 50 cm revestimiento para absorber ruidos distancia entre pisos 28 cm / 29 cm, 4 ruedas giratorias 12,5 cm, con frenos, se sirve desmontado, montaje fácil, carga máx. 33 kg por piso

structure en tube carré 25x25 mm, 3 niveaux dimensions utiles 84x44,5 cm, encombrement au sol 90x50 cm, avec revêtement en partie inférieure pour absorber le bruit, distance entre niveaux 28 cm / 29 cm, 4 roues pivotantes 12,5 cm, avec frein, livré démonté, montage aisé, max. 33 kg de charge par niveau

	cm	↑ cm
71440	96 x 50	94



Servier- / Transportwagen

service trolley  
carro de servicio  
chariot de service



mit 3 Borden, Bordmaße ca. 83 x 51 cm, Abstand zwischen den Borden ca. 26 cm, Tragfähigkeit 120 kg, 4 Lenkrollen, davon 2 feststellbar, Lieferung demontiert, einfache Montage

with 3 trays, trays approx. 83 x 51 cm, size between the trays approx. 26 cm, total load capacity 120 kg, 4 wheels with 2 brakes, unassembled, simple assembly

con 3 bandejas inox mate, aprox. 83 x 51 cm, la medida entre bandejas aprox. 26 cm capacidad total 120 kg, 4 ruedas con 2 frenos, construcción robusta, montaje fácil

3 niveaux, approx. 83x51 cm chacun, distance entre niveaux 26 cm, capacité maxi 120 kg au total, 4 roues dont 2 avec frein, construction robuste, montage facile

	cm	↑ cm
11979	91 x 59	93



Servier- / Transportwagen

service trolley  
carro de servicio  
chariot de service



mit 2 Borden, Bordmaße ca. 83 x 51 cm, Abstand zwischen den Borden ca. 56 cm, Tragfähigkeit 80 kg, 4 Lenkrollen, davon 2 feststellbar, Lieferung demontiert, einfache Montage

with 2 trays, trays approx. 83 x 51 cm, size between the trays approx. 56 cm, total load capacity 80 kg, 4 wheels with 2 brakes, unassembled, simple assembly

con 2 bandejas de acero inoxidable mate, aprox. 83 x 51 cm, la medida entre bandejas aprox. 56 cm, capacidad total 80 kg, 4 ruedas, con 2 frenos, construcción robusta, montaje fácil

2 niveaux, approx. 83x51 cm chacun, distance entre niveaux 56 cm, capacité maxi 80 kg au total, 4 roues dont 2 avec frein, construction robuste, montage facile

	cm	↑ cm
11977	91 x 59	93



### GN 1/1 Regalwagen

GN 1/1 trolley  
GN 1/1 carro  
GN 1/1 chariot



mit 15 Doppelauflegeschieben, zum Transport von bis zu 30 GN-Tablets GN 1/2 oder 15 GN-Behältern bis GN 1/1 (Längseinschub), bei einem Stapelabstand von 75 mm, mit 4 Lenkrollen, 2 mit Feststellern, Tragfähigkeit 100 kg

15 double bars, for transporting up to 30 trays GN 1/2 or 15 GN containers up to GN 1/1 (lengthwise insertion), size between the trays 75 mm, with 4 swivel wheels, 2 with brakes, max. load 100 kg

15 raíles de soporte dobles, para transportar hasta 30 bandejas GN 1/2 o 15 cubetas GN hasta GN 1/1 (inserción longitudinal), distancia entre las bandejas de 75 mm, con 4 ruedas giratorias, 2 con freno, carga máxima de 100 kg

15 doubles rails de support, pour transporter jusqu'à 30 plateaux GN 1/2 ou 15 bacs GN jusqu'à GN 1/1 (insertion longitudinale), distance entre les plateaux 75 mm, avec 4 roues pivotantes, 2 avec frein, capacité de charge 100 kg

	cm	↑ cm
71441	55 x 38,5	173,5



mit beidseitiger Kipp- und Durchschubsicherung  
with tilt and push-through protection on both sides



### Servier- / Transportwagen

serving trolley  
carro de servicio  
chariot de service



Aluminiumrahmen, 3 Böden, Abstand zwischen den Böden 31 cm, mit 4 Lenkrollen, alle mit Feststellern, Tragfähigkeit: ca. 80 kg je Boden, 240 kg insgesamt, demontiert, einfache Montage, Lieferung ohne Container und Dekoration

frame aluminium, 3 shelves, distance between shelves 31 cm, 4 swivel wheels, all equipped with brakes, max. load per shelf 80 kg, 240 kg total, demounted, easy to mount, delivery without containers and decoration

marco aluminio, 3 pisos, distancia entre cada piso 31 cm, 4 ruedas giratorias, las 4 con frenos, carga máxima por bandeja 80 kg, 240 kg en total, se sirve desmontado, fácil de montar (se entrega sin contenedores ni decoración)

chassis aluminium, 3 étages, distance entre niveaux 31 cm, 4 roues pivotantes, toutes avec frein, charge maximum 80 kg par niveau, 240 kg au total, livré démonté, montage facile (livré sans récipients ni décoration)

	cm	↑ cm	
11945	108 x 50	96	without containers



### Container

container  
contenedor  
récipient



zum Einhängen, passend zum Servier- / Transportwagen 11945

to hang up, suitable serving trolley 11945

para colgar, adaptado para el carro ref. 11945

à suspendre, pour chariot de service 11945

	cm	↑ cm	ltr.
11946	33 x 23	56,5	42
11947	33 x 23	17,5	13

# CHAFING DISH · GN CONTAINER · TRANSPORT



## GN 1/1 Besteckbehälter

GN 1/1 dispenser GN  
GN 1/1 dispensador de cubiertos  
GN 1/1 bac à couverts



in Handarbeit geflochten, 4 Mulden, Kunststoff-Geflecht, Drahtgestell, braun-schwarz  
wickerwork, 4 compartments, with reinforced chromed wire structure, brown-black  
cesta trensada a mano, 4 compartimentos, de plástico, con bastidor cromado reforzado, marrón oscuro  
corbeille tressée à main, 4 compartiments, en plastique, cadre acier chromé renforcé, couleur marron foncé

	cm	↑ cm	Farbe / Colour
11966	53 x 32,5	9	



## GN 1/1 Besteckbehälter „BUFFET“

GN 1/1 cutlery dispenser  
GN 1/1 dispensador de cubiertos  
GN 1/1 bac à couverts



4 Mulden, Kunststoff-Geflecht, Drahtgestell, beige

4 troughs, wickerwork, wire, beige

4 huecos, trabajo de cestería

4 compartiments, plastique tressé, cadre acier chromé renforcé, couleur osier naturel

	cm	↑ cm	Farbe / Colour
11965	53 x 32,5	10	



## GN 1/1 Besteckbehälter

GN 1/1 cutlery tray / box stand  
GN 1/1 dispensador de cubiertos  
GN 1/1 bac à couverts



	cm	↑ cm	Farbe / Colour
11955	53 x 32,5	10	



## GN 1/1 Besteckkasten

cutlery box GN 1/1  
GN 1/1 dispensador de cubiertos  
GN 1/1 bac à couverts



	cm	↑ cm	Farbe / Colour
11960	53 x 32,5	10	



## GN 1/1 Besteckbehälter

GN 1/1 cutlery bin  
GN 1/1 recipiente para cubiertos  
GN 1/1 récipients pour couverts



	cm	↑ cm	Farbe / Colour
11954	53 x 32,5	10	
11955	53 x 32,5	10	



**Besteckbehälter**  
 cutlery basket  
 recipiente para cubiertos  
 récipients pour couverts

4 Löcher inkl. 4 Edelstahl Köcher  
 4 holes incl. 4 stainless baskets  
 4 agujeros, incl. 4 cestas de acero  
 4 places, avec 4 corbeille inox



	cm	↑ cm	Farbe / Colour
93321	27 x 27	15	■



**Besteckbehälter**  
 cutlery basket  
 dispensador de cubiertos  
 présentoir à couverts

matt poliert  
 satin polished finish  
 inox mate (sin cubiertos)  
 inox mat



	cm	↑ cm	
11994	26,0 x 30 Ø 10	20	4 Löcher inkl. Köcher (Kunststoff) 4 holes incl. dispensers (plastic) 4 agujeros incl. dispensador plástico 4 places, avec 4 récipients (plastique)
11997	37,5 x 30 Ø 10	20	6 Löcher ohne Köcher 6 holes without dispensers 6 agujeros sin dispensador de plástico 6 places, sans récipients



11998  
 Köcher weiß / PE white

**Besteckköcher**  
 cutlery basket  
 cesta para cubiertos  
 corbeille à couverts



	Ø cm	↑ cm	
11998	9,7	13,7	Kunststoff weiß / white plastic plástico blanco / plastique blanc



11999  
 Köcher Edelstahl / stainless steel

**Besteckköcher**  
 cutlery basket  
 cesta para cubiertos  
 corbeille à couverts



	Ø cm	↑ cm	
11999	9,7	13,7	matt poliert / satin polished finish acero inoxidable / inox



# CHAFING DISH · GN CONTAINER · TRANSPORT



**Teig- und Pizzaballenbehälter**  
 dough and pizza ball container  
 recipiente para masa y bolas de pizza  
 récipient à pâte et boules à pizza



**Innenmaß 56,5 x 36,5 cm, H: 7 cm**  
 inner dimension 56,5 x 36,5 cm, H: 7 cm  
 medida interior 56,5 x 36,5 cm, H: 7 cm  
 dimension intérieure 56,5 x 36,5 cm, H: 7 cm

	cm	↑ cm	ltr.
82440	60 x 40	7,5	14

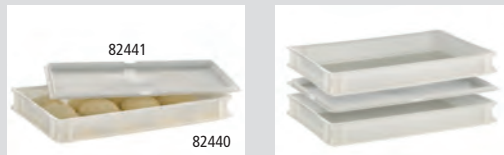

**stapelbar**  
 stackable

passender Deckel / fitting lid / tapa adecuada / couvercle approprié

	cm	↑ cm	
82441	60 x 40	1	



**Eier-Box**  
 eggs box  
 caja para huevos  
 boîte à oeufs



**mit luftdichtem Deckel, für 4 Lagen à 30 Eier, Lieferung inkl. 8 Lagen, Größe Lage: 28 x 28 cm**  
 with airtight cover, capacity: 4 trays of 30 eggs, delivery with 8 trays, size of tray: 28 x 28 cm  
 capacidad para 4 bandejas de 30 huevos, tapa hermética, se entrega con 8 bandejas, formato bandejas 28 x 28 cm, apto para lavavajillas  
 pour 4 plateaux de 30 oeufs chacun, apte pour 4 plateaux plats, couvercle hermétique, livré avec 8 plateaux, dimension plateau 28x28 cm, lavable en lave-vaisselle

	cm	↑ cm	GN
82419	35,4 x 32,5	20	2/3

10 Lagen / 10 trays / 10 bandejas / 10 plateaux

82420



**Wanne**  
 container  
 cubeta  
 bac



	cm	↑ cm	ltr.
11940	61 x 44	15	25

**stabile Ausführung**  
 robust



**Wanne**  
 container  
 cubeta  
 bac



	cm	↑ cm	ltr.
11950	55 x 42	14	20

NEW



10,5 ltr.

30075



17 ltr.

30078

Profi-Eimer

bucket  
cubo  
seau



mit Ausgießer und geprägter Maßskalierung innen  
with spout and embossed dimension scaling inside  
con pico y escala de medición en relieve en el interior  
avec bec verseur et échelle de mesure en relief à l'intérieur

	Ø cm	↑ cm	ltr.	Farbe / Colour
30075	28,5	28,5	10,5	White
30076	33,0	32,0	17,0	White
30077	28,5	28,5	10,5	Black
30078	33,0	32,0	17,0	Black



30077



30076



mit Griff  
with handle

Maßskalierung innen  
dimension scaling  
inside

Auslaufnase für sicheres Handling  
discharge nose for safe handling

NEW

Ø 6 cm



30065

Ø 12 cm



30068

Ø 17 cm

inkl. Sieb  
incl. strainer



30070

Trichter „PROFI“

funnel  
embudo  
entonnoir

mit Öse  
with eyelet  
con ojal  
avec œillet



	Ø cm	Ø mm Durchlass	
30065	6	8	
30066	8	11	
30067	10	12	
30068	12	12	
30069	14	15	
30070	17	17	mit Sieb / incl. strainer
30071	21	20	mit Sieb / incl. strainer



30066



30065



30071

erleichtert das Einfüllen  
facilitates filling

Anwendungsmöglichkeit  
applicability

mit einsetzbarem Sieb  
incl. insertable strainer







# Bar, Café Drinkware





**Flaschenkühler „MOSCOW MULE“**

bottle cooler  
enfriador de botellas  
rafraîchisseur de bouteilles

Edelstahl-Flaschenkühler, Antik-Kupfer-Look  
stainless steel cooler, copper antique look  
enfriador de acero inoxidable, cobre estilo antiguo  
rafraîchisseur en acier inox, cuivre style antique



	Ø cm	↑ cm	ltr.	
93330	20	21	5	copper-antique-hammered



**Wein- / Sektkühler „TROPHY“**

wine / champagne bowl  
cubitera para vino y cava  
seau à vin ou champagne

hochglanzpoliert, mit Griffen, Fuß Ø 18,5 cm,  
mirror polished finish, with handles, foot Ø 18,5 cm  
pulido brillante, 2 asas, pie ø 18,5 cm  
brillant, 2 anses, pied ø 18,5 cm



	Ø cm	↑ cm	ltr.	
36092	23	24	5	stainless-steel
36093	23	24	5	copper-look



**Wein- / Sektkühler**

wine / champagne bowl  
cubitera para vino y cava  
seau à vin ou champagne

innen mattiert, außen hochglanzpoliert, mit massiven Knopf-Griffen,  
extra stabiler ingerollter Rand, schwere Ausführung  
outside mirror polished finish, inside satin polished finish,  
with solid knob handles, rolled edge, heavy quality  
acabado pulido brillante, asas de botón robustas, borde redondeado, alta calidad  
brillant, 2 poignées robuste en forme de bouton, bord arrondi, haute qualité



	Ø cm	↑ cm	ltr.
36028	21,5 / 16	22	4



**Wein- / Sektkühler**

wine / champagne bowl  
cubitera para vino y cava  
seau à vin ou champagne

innen mattiert, außen poliert, mit massiven Griffen, Rand ingerollt  
outside mirror polished finish, inside satin polished finish, with massive handles, rolled edge  
pulido mate, 2 asas macizas, borde redondeado  
finition mate, 2 anses massives, bord rond



	Ø cm	↑ cm	ltr.
36025	21 / 15	21	3,5



**Mini-Eiseimer / Mini-Sektkühler**

ice bucket  
cubitera clásica  
seau à glaçons classique



	Ø cm	↑ cm	ltr.
36003	10,5	10	0,5
36004	13,0	13	1,0



**Wein- / Sektkühler**

wine / champagne bowl  
cubitera para vino y cava  
seau à vin ou champagne



**aussen hochglanzpoliert, innen matt poliert, mit Ring-Griffen**  
outside mirror polished finish, inside satin polished finish, with ring handles  
exterior pulido brillante, interior efecto satinado con 2 asas anillos  
extérieur brillant, intérieur satin, avec 2 anneaux

	Ø cm	↑ cm	ltr.
36020	20 / 15	19	3



**Wein- / Sektkühler**

wine / champagne bowl  
cubitera para vino y cava  
seau à vin ou champagne



**matt poliert, Hohlgriffe**  
satin polished finish, hollow handles  
acabado pulido satinado, con asas huecas  
finition mate, 2 boutons creux

	Ø cm	↑ cm	ltr.
36021	20 / 15	20,5	4



**Wein- / Sektkühler „HAMMERSCHLAG“**

wine / champagne bowl  
cubitera para vino y cava  
seau à vin ou champagne



**hochglanzpoliert, mit massiven Ring-Griffen, eingerollter Rand**  
mirror polished finish, with solid ring handles, rolled edge, hammered  
acabado pulido brillante, con 2 anillos macizos, borde redondeado, repujado  
brillant, 2 anneaux massifs, bord arrondi, surface martelée

	Ø cm	↑ cm	ltr.
36026	21 / 17	21,5	4



**Wein- / Sektkühler**

wine / champagne bowl  
cubitera para vino y cava  
seau à vin ou champagne



**glasklarer Rand, transparent gefrostet**  
edge transparent, body transparent frosted  
borde transparente, cuerpo transparente efecto glaseado  
bord transparent, corps finition mate

	Ø cm	↑ cm	ltr.
36066	22 / 14	23	4



**Wein- / Sektkühler**

wine / champagne bowl  
cubitera para vino y cava  
seau à vin ou champagne



**glasklar, mit Tragegriff**  
transparent, handle on the side  
transparente, con un asa en el lateral  
transparent, avec poignée

	cm	↑ cm	ltr.
36055	23 x 22	27,5	3



**Ständer für Wein- / Sektkühler**

stand for wine / champagne bowl  
pie porta champañera / vino  
pied pour seau à champagne / vin



hochglanzpoliert, schwerer standsicherer Fuß, Innendurchmesser der Schale Ø 15 cm  
mirror polished finish, heavy foot, inner bowl Ø 15 cm  
acabado pulido efecto brillante, bol interior de Ø 15 cm  
brillant, intérieur support Ø 15 cm

	Ø cm	↑ cm
36068	15 / 28	68



**Ständer für Wein- / Sektkühler**

stand for wine / champagne bowl  
pie porta champañera / vino  
pied pour seau à champagne / vin



hochglanzpoliert, schwerer standsicherer Fuß, Innendurchmesser der Schale Ø 17,5 cm  
mirror polished finish, heavy foot, inner bowl Ø 17,5 cm  
acabado pulido efecto brillante, bol interior de Ø 17,5 cm  
brillant, intérieur support Ø 17,5 cm

	Ø cm	↑ cm
36069	17,5 / 26,5	73



Wein- / Sektkühler no. 36028  
wine / champagne bowl no. 36028  
cubitera para vino y cava no. 36028  
seau à vin ou champagne no. 36028



**Tischhalterung für Sektkühler**

champagne bucket table holder  
soporte champañera universal  
porte-seau à champagne



aus 8 mm starkem Stahldraht, passen zu allen lieferbaren Sektkühlern, innen Ø-Ring: 18 cm  
8 mm chrome plated wire, suitable for all available champagne buckets, inner ring Ø 18 cm  
alambre cromado 8 mm, para todas las champañeras, anillo interior Ø 18 cm  
fil chromé 8 mm, pour tous les seaux à champagne, anneau intérieur Ø 18 cm

	cm	↑ cm
30332	49 x 20	17



**Gläserische**

glass rack  
rack de copas  
rack porte-verres



aus 6 mm Draht, Metall verchromt, Wand- und Deckenmontage möglich  
6 mm chrome plated wire, can be mounted under a shelf or on the wall  
alambre cromado de 6 mm, puede instalarse bajo una estantería o en la pared  
fil chromé de 6 mm, à installer sous une étagère ou contre un mur

	cm	↑ cm	for glasses	Farbe / Colour
93398	29,5 x 32	6	12	chrome
93399	29,5 x 32	6	12	black
93400	45,0 x 32	6	20	chrome



**Flaschenkühler**

bottle cooler  
enfriador de botella  
rafraîchisseur de bouteille

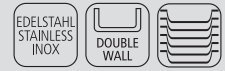

doppelwandig für beste Isolierung, außen Hammerschlag-Optik  
double-walled for best insulation, outside: hammered surface  
doble pared para un mejor aislamiento, exterior: aspecto martillado  
double paroi pour une meilleur isolation, extérieur: surface martelée

	Ø cm	↑ cm	ltr.	Farbe / Colour
36120	33	20	8	stainless
36121	33	20	8	copper-look



Präsentationsmöglichkeit  
presentation examples



**Wein- / Sektkühler**

wine / champagne bowl  
cubitera para vino y cava  
seau à vin ou champagne



gehämmerte Oberfläche mit 2 seitlichen Eingriffen  
hammered surface with 2 handles on the side  
superficie martillada con 2 asas  
surface martelée avec 2 poignées

	cm	↑ cm	ltr.	Farbe / Colour
36111	30 x 23,5	23	7	copper-look



**Wein- / Sektkühler**

wine / champagne bowl  
cubitera para vino y cava  
seau à vin ou champagne



gehämmerte Oberfläche mit 2 seitlichen Eingriffen  
hammered surface with 2 handles on the side  
superficie martillada con 2 asas  
surface martelée avec 2 poignées

	cm	↑ cm	ltr.	Farbe / Colour
36112	30 x 23,5	23	7	gunmetal-look



**Getränkewanne „TIN“**

beverage tub  
barreño botellines  
bassine à glace



Metall verzinkt, mit Kunststoffeinsatz, mit massiven Ring-Griffen  
galvanised metal, with plastic insert, with solid ring handles  
metal galvanizado, con inserto de plástico, con 2 anillos macizos  
métal galvanisé, avec insert en plastique, 2 anneaux massifs



	cm	↑ cm	ltr.
36095	40 x 28	22	11
36096	50 x 32	23	18

2 sizes available with ring handles





**Getränkewanne „TIN“**

beverage tub  
barreño botellines  
bassine à glace



**Metall verzinkt, mit Kunststoffeinsatz, mit massiven Ring-Griffen**  
galvanised metal, with plastic insert, with solid ring handles  
metal galvanizado, con inserto de plástico, con 2 anillos macizos  
métal galvanisé, avec insert en plastique, 2 anneaux massifs

	cm	↑ cm	ltr.	Farbe / Colour
36100	40 x 28	22	11	copper-look
36101	40 x 28	22	11	black-metal-look



mit Kunststoffeinsatz  
with plastic insert  
con inserto de plástico  
avec insert en plastique



**Kreidestift zum Beschriften**  
chalk marker for writing  
S. 348



**Champagnerkühler**

champagne bowl  
cubo champañera  
seau à champagne



**hochglanzpoliert, Rand matt poliert**  
mirror polished finish, edge satin polished finish  
acabado pulido brillante, borde satinado  
brillant, bord mat

	Ø cm	↑ cm	ltr.
36046	45 / 21	23	12



**Champagnerkühler**

champagne bowl  
cubo champañera  
seau à champagne



**hochglanzpoliert**  
mirror polished finish  
acabado efecto brillante  
brillant

	Ø cm	↑ cm	ltr.
36045	40,5 / 27,5	22,5	13,5



**Champagnerkühler**

champagne bowl  
cubo champañera  
seau à champagne



**außen hochglanzpoliert, innen matt poliert, mit vergoldeten Griffen**  
outside mirror polished finish, inside satin polished finish, with gold plated handles  
exterior pulido brillante, interior satinado  
extérieur brillant, intérieur satin

	Ø cm	↑ cm	ltr.
36047	42 / 27	28	20



### Flaschenkühler „BRIDGE“

bottle cooler  
enfriador de botellas  
rafraîchisseur de bouteilles

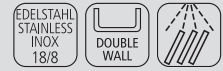

**doppelwandig für beste Isolierung, außen poliert, innen mattiert**

double wall cooler keeps the temp. for a long time, outs. mirror polished, inside matt finish  
champañera inox de doble pared, interior mate, exterior brillante  
seau inox double paroi, maintient le froid plus longt., intérieur mat, extérieur poli brillant

	Ø cm	↑ cm	ltr.
36077	31	19	10



### Konferenzkühler „BRIDGE“ no. 13985

bottle cooler no. 13985  
enfriador no. 13985  
rafraîchisseur no. 13985



### Champagnerkühler

champagne bowl  
cubo champañera  
seau à champagne

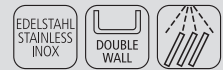

**hochglanzpoliert, doppelwandig für beste Isolierung**

mirror polished finish, double wall cooler keeps the temp. for a long time  
acabado pulido brillante con champañera inox de doble pared  
brillant, double paroi, maintient le froid plus longt.

	Ø cm	↑ cm	ltr.
36044	44 / 25	24	10,5



### Wein- / Sektkühler

wine / champagne bowl  
cubitera para vino y cava  
seau à vin ou champagne



**mit seitlichen Griffen, transparent**

with lateral handles, transparent  
con asas laterales  
avec poignées latérales

	cm	↑ cm	ltr.
36087	32 x 21,5	24,5	7



### Wein- / Sektkühler

wine / champagne bowl  
cubitera para vino y cava  
seau à vin ou champagne



**glasklar, für bis zu 6 Flaschen geeignet**

transparent, suitable for up to 6 bottles  
transparente, para máximo 6 botellas  
transparent, maxi 6 bouteilles

	cm	↑ cm	ltr.
36057	47 x 28	23	10



36048

**Wein- / Sektkühler**  
 wine / champagne bowl  
 cubitera para vino y cava  
 seau à vin ou champagne



**mit 2 seitlichen Eingriffen**  
 with 2 handles on the side  
 con 2 asas  
 avec 2 poignées

	cm	↑ cm	ltr.
36048	35 x 27	25,5	6
36052	27 x 20	21	3



36054

**Wein- / Sektkühler**  
 wine / champagne bowl  
 cubitera para vino y cava  
 seau à vin ou champagne



**mit 2 seitlichen Eingriffen**  
 with 2 handles on the side  
 con 2 asas  
 avec 2 poignées

	cm	↑ cm	ltr.	Farbe / Colour
36054	35 x 27	25,5	6	■
36053	27 x 20	21,0	3	■



**Wein- / Sektkühler**  
 wine / champagne bowl  
 cubitera para vino y cava  
 seau à vin ou champagne



**glasklar, für zwei Flaschen**  
 clear, for two bottles  
 transparente, para 2 botellas  
 transparent, pour 2 bouteilles

	cm	↑ cm	ltr.
36056	30,5 x 21,5	26	4



**Flaschenkühler**  
 bottle cooler  
 enfriador de botella  
 rafraîchisseur de bouteille



**matt poliert, doppelwandig für beste Isolierung**  
 satin polished finish, double wall cooler keeps the temperature for a long time,  
 for 0,7 - 1,5 ltr. bottles  
 acero inoxidable mate con doble pared para mantener el frio largo tiempo,  
 para botellas de 0,7 - 1,5 ltr.  
 inox mat, double paroi pour une meilleure conservation de la température,  
 pour bouteilles de 0,7 à 1,5 l.

	Ø cm	↑ cm
36038	12,5 / 10	19



**Flaschenkühler „COPPER“**

bottle cooler  
enfriador de botella  
rafraîchisseur de bouteille

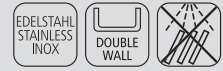

**Hammerschlag-Optik, doppelwandig für beste Isolierung, für 0,7 - 1,5 Liter-Flaschen**  
double wall cooler keeps the temperature for a long time, hammered look, for 0,7 - 1,5 ltr. bottles  
doble pared para mantener el frío largo tiempo, para botellas de 0,7 - 1,5 ltr.  
double paroi pour une meilleure conservation de la température, pour bouteilles de 0,7 à 1,5 l.

	Ø cm	↑ cm	Farbe / Colour
36074	12 / 10	20	



1:1 Oberflächenansicht  
1:1 structural view



**Flaschenkühler**

bottle cooler  
enfriador de botella  
rafraîchisseur de bouteille

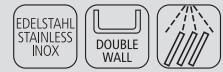

**matt poliert, doppelwandig für beste Isolierung, für 0,7 - 1,5 Liter-Flaschen**  
satin polished finish, double wall cooler keeps the temperature for a long time, for 0,7 - 1,5 ltr. bottles  
acero inoxidable mate con doble pared para mantener el frío largo tiempo, para botellas de 0,7 - 1,5 ltr.  
inox mat, double paroi pour une meilleure conservation de la température, pour bouteilles de 0,7 à 1,5 l.

	Ø cm	↑ cm
36030	12 / 10	20



**Flaschenkühler**

bottle cooler  
enfriador de botella  
rafraîchisseur de bouteille



**transparent, doppelwandig für beste Isolierung, mit Chromrand**  
transparent, double wall cooler keeps the temperature for a long time, with chrome edge  
transpar., doble pared mantiene la temperaruta por largo tiempo, borde superior cromado  
transparent, bord chromé brillant, double paroi pour maintien en température

	Ø cm	↑ cm	Farbe / Colour
36032	12 / 10	23	
36034	12 / 10	23	



**Flaschenkühler „PURE“**

bottle cooler  
enfriador de botella  
rafraîchisseur de bouteille



**doppelwandig für beste Isolierung, glasklar**  
double wall cooler keeps the temperature for a long time, clear  
doble pared mantiene la temperaruta por largo tiempo, transparente  
double paroi pour maintien en température, transparent

	Ø cm	↑ cm
36063	13,5 / 10,5	23





**Flaschenkühler „CRYSTAL“**

bottle cooler  
enfriador de botella  
rafraîchisseur de bouteille



**doppelwandig für beste Isolierung, glasklar**

double wall cooler keeps the temperature for a long time, clear  
doble pared mantiene la temperatura por largo tiempo, transparente  
double paroi pour maintien en température, transparent

	∅ cm	↑ cm
36062	13,5 / 10,5	23



**Flaschenkühler**

bottle cooler  
enfriador de botella  
rafraîchisseur de bouteille



**Rand matt poliert, doppelwandig für beste Isolierung, für 0,7 - 1,5 Liter Flaschen**

satin polished finish edge, double wall cooler keeps the temperature for a long time, for 0,7 - 1,5 ltr. bottles  
borde pulido satinado, con doble pared para mantener más tiempo la temperatura para botellas de 0,7 a 1,5 l.  
bord métallique mat, double paroi pour excellente conservation de la température, pour bouteilles de 0,7 à 1,5 l.

	∅ cm	↑ cm
36050	11,5 / 9,5	23



36090

**Flaschenkühler ELEMENT“**

bottle cooler  
enfriador de botella  
rafraîchisseur de bouteille



**Beton, mit möbelschonender Unterseite**

concrete, with non-scratching undersurface  
hormigón, con base anti rayaduras  
béton, avec base revêtement antirayures

	cm	↑ cm	Farbe / Colour
36090	12 / 10	19	



36099

**Flaschenkühler „ELEMENT BLACK“**

bottle cooler  
enfriador de botella  
rafraîchisseur de bouteille



**Beton, mit möbelschonender Unterseite**

concrete, with non-scratching undersurface  
hormigón, con base anti rayaduras  
béton, avec base revêtement antirayures

	cm	↑ cm	Farbe / Colour
36099	12 / 10	19	



### Kühlmanschette „CHAMPAGNE“

cool collar  
funda de frío  
housse isotherme



für Sekt- / Champagnerflaschen, einfach im Gefrierfach einfrieren, komplette Flasche wird in 5 Min. auf angenehme Trinktemperatur gekühlt, außen reißfestes Stoffgewebe, innen Kunststoff mit Kühlgel gefüllt, unbegrenzt wiederverwendbar

for bottles of champagne, simply to freeze in the freezer, complete bottles will be cooled down in only 5 minutes, tearproof cloth outside, plastic filled with gel inside, unlimited reusable

para botellas de cava o champán simplemente congelándola en el congelador, la botella entera se enfriará en 5 minutos, funda de plástico muy robusta, rellena con un gel congelante reutilizable ilimitadamente

pour bouteilles de vin ou champagne, la housse est préalablement stockée au congélateur, où elle accumule le froid, ensuite elle refroidit une bouteille en quelques minutes, plastique résistant, contient un liquide congelant, à réutiliser de façon illimitée

	Ø cm	↑ cm
36075	11	18



### Pitcher

pitcher  
jarra  
pichet



	Ø cm	↑ cm	ltr.
93105	13	21	1,5



### Weinflaschenhalter

winebottle-stand  
soporte para botella de vino  
porte-bouteille



	cm	↑ cm
30333	22 x 6	20,5



### Flaschenträger

bottle rack  
porta botellas  
porte-bouteilles



für 6 Flaschen, Ring Ø 9,5 cm

for 6 bottles, ring Ø 9,5 cm

para 6 botellas, Ø 9,5 cm

pour 6 bouteilles, Ø 9,5 cm

	cm	↑ cm
00630	32 x 21,5	32,5



### Bierglasträger

beer rack  
porta vasos de cerveza  
porte verres à bière



für Glasgrößen 0,2 - 0,3 Liter, für 10 Gläser, Ring Ø 6,5 cm

for glasses size 0,2 - 0,3 liter, for 10 glasses, ring Ø 6,5 cm

para vasos tamaño 0,2-0,3 l, para 10 vasos, Ø 6,5 cm

pour verres de 0,2 à 0,3 l, pour 10 verres, Ø 6,5 cm

	cm	↑ cm
00632	40 x 16,5	29

# CRYSTAL



UNZERBRECHLICH | UNBREAKABLE



Trinkbecher „CRYSTAL“  
drinking cups  
vasos  
gobelets



Kristallglas-Optik, vielseitig einsetzbar, robustes, unzerbrechliches Material, ideal in sensiblen Bereichen wie Pool, Spa, Beach und Wellness einzusetzen, BPA-frei  
crystal-glass-look, can be used in versatile ways, a solide and unbreakable material, ideal to be used at pool, spa, beach and wellness areas, bpa-free

aspecto vidrio, se pueden utilizar de muchas maneras diferentes, material sólido e irrompible, ideal para el uso en áreas como piscina, spa, playa y bienestar, libre de BPA  
ressemble à un verre de cristal, peuvent être utilisés de différentes façons, matériau robuste et incassable, idéal pour une utilisation dans des zones comme la piscine, le spa, la plage et le bien-être, sans BPA

	Ø cm	↑ cm	ltr.	VE	Farbe / Colour
10500	7	9,5	0,15	48	—
10503	7,5	11,0	0,20	48	—
10501	8	12,5	0,30	48	—
10504	8,5	14,0	0,40	48	—
10502	9	15,5	0,50	48	—

	Ø cm	↑ cm	ltr.	VE	Farbe / Colour
10513	7	9,5	0,15	48	
10516	7,5	11,0	0,20	48	
10514	8	12,5	0,30	48	
10517	8,5	14,0	0,40	48	
10515	9	15,5	0,50	48	



UNZERBRECHLICH  
UNBREAKABLE

## Made in Germany

Auch die inneren Werte können sich sehen lassen. Der Trinkbecher „CRYSTAL“ wird ressourcenschonend ausschließlich in Deutschland produziert. Das Material ist zu 100% recycelbar.





	Ø cm	↑ cm	ltr.	VE	Farbe / Colour
10510	7	9,5	0,15	48	
10511	8	12,5	0,30	48	
10512 <small>NEW</small>	9	15,5	0,50	48	
	Ø cm	↑ cm	ltr.	VE	Farbe / Colour
10525	7	9,5	0,15	48	
10526 <small>NEW</small>	8	12,5	0,30	48	
10527	9	15,5	0,50	48	
	Ø cm	↑ cm	ltr.	VE	Farbe / Colour
10528	7	9,5	0,15	48	
10529	8	12,5	0,30	48	
10530	9	15,5	0,50	48	
	Ø cm	↑ cm	ltr.	VE	Farbe / Colour
10531	7	9,5	0,15	48	
10532	8	12,5	0,30	48	
10533	9	15,5	0,50	48	
	Ø cm	↑ cm	ltr.	VE	Farbe / Colour
10534	7	9,5	0,15	48	
10535	8	12,5	0,30	48	
10536	9	15,5	0,50	48	



**UNZERBRECHLICH**  
**UNBREAKABLE**













**Farbe grau**  
colour light grey



**stapelbar**  
stackable

10509

**Trinkglas „BEACH“**  
drinking glass  
vaso  
verre

vielseitig einsetzbar, robustes, unzerbrechliches Material, BPA-frei  
can be used in versatile ways, a solide and unbreakable material, bpa-free  
se pueden utilizar de muchas maneras diferentes, material sólido e irrompible, libre de BPA  
peuvent être utilisés de différentes façons, matériau robuste et incassable, sans BPA

	Ø cm	↑ cm	ltr.	VE	Farbe / Colour
10509 <small>NEW</small>	8,5	13,5	0,30	48	
10505	8,5	13,5	0,30	48	–





Trinkbecher „LINEA“  
drinking cups  
vasos  
gobelets



Die elegant facettierten Bechergläser LINEA lassen sich vielseitig im Bar-, Club-, Pool-, und Buffetbereich verwenden. Sowohl die transparenten als auch die farbigen Modelle setzen in jedem Ambiente edle Akzente. Dank ihrer perfekten Stapelbarkeit werden sie platzsparend aufbewahrt und transportiert.

The elegantly faceted tumbler glasses LINEA can be used in a variety of ways in the bar, club, pool and buffet areas. Both the transparent and coloured models set elegant accents in any ambience. Thanks to their perfect stackability, they are space-saving to store and transport.

Los vasos LINEA, elegantemente facetados, pueden utilizarse de diversas maneras en el bar, el club, la piscina y el buffet. Tanto los modelos transparentes como los de color ponen elegantes acentos en cualquier ambiente. Gracias a su perfecta apilabilidad, ahorran espacio para su almacenamiento y transporte.

Les verres LINEA élégamment facetés peuvent être utilisés de manière polyvalente dans les bars, les clubs, les piscines et les buffets. Les modèles transparents et colorés apportent une touche de noblesse dans chaque ambiance. Grâce à leur parfaite empilabilité, ils se rangent et se transportent avec un minimum d'encombrement.

	Ø cm	↑ cm	ltr.	VE	Farbe / Colour
10560	6,5	8,0	0,15	48	—
10561	8,5	8,0	0,22	48	—
10562	8,5	10,0	0,30	48	—
10563	8,5	12,0	0,40	48	—
10564	8,5	15,0	0,50	48	—
10565	6,5	8,0	0,15	48	■ french grey
10566	8,5	8,0	0,22	48	■ french grey
10567	8,5	10,0	0,30	48	■ french grey
10568	8,5	12,0	0,40	48	■ french grey
10569	8,5	15,0	0,50	48	■ french grey
10570	6,5	8,0	0,15	48	■ light green
10571	8,5	8,0	0,22	48	■ light green
10572	8,5	10,0	0,30	48	■ light green
10573	8,5	12,0	0,40	48	■ light green
10574	8,5	15,0	0,50	48	■ light green
10575	6,5	8,0	0,15	48	■ light pink
10576	8,5	8,0	0,22	48	■ light pink
10577	8,5	10,0	0,30	48	■ light pink
10578	8,5	12,0	0,40	48	■ light pink
10579	8,5	15,0	0,50	48	■ light pink



# MOSCOW MULE



## Flaschenkühler „MOSCOW MULE“

bottle cooler  
enfriador de botellas  
rafraîchisseur de bouteilles



Edelstahl-Flaschenkühler, Antik-Kupfer-Look  
stainless steel cooler, copper antique look  
enfriador de acero inoxidable, cobre estilo antiguo  
rafraîchisseur en acier inox, cuivre style antique

	Ø cm	↑ cm	ltr.	Farbe / Colour
93330	20	21	5	 copper-antique-hammered



## Becher „MOSCOW MULE“, 2er-Set

barrel copper mug, 2 pcs.  
taza, set de 2  
gobelet, set de 2



Edelstahlbecher, Antik-Kupfer-Look  
stainless steel cup, copper antique look  
taza de acero inoxidable, cobre estilo antiguo  
gobelet en acier inox, cuivre style antique

	Ø cm	↑ cm	ltr.	Farbe / Colour
93367	9	10	0,5	 copper-antique-hammered



## Becher „MOSCOW MULE“

barrel mug  
taza  
gobelet



Edelstahlbecher, Antik-Edelstahl-Look  
stainless steel cup, stainless steel antique look  
taza de acero inoxidable, acero estilo antiguo  
gobelet en acier inox, acier style antique

	Ø cm	↑ cm	ltr.	Farbe / Colour
93346	9	10	0,5	 stainless-antique-hammered



**Becher „MOSCOW MULE“**

barrel mug  
taza  
gobelet



**Edelstahlbecher, Antik-Edelstahl-Look**  
stainless steel cup, stainless antique look  
taza de acero inoxidable, acero estilo antiguo  
gobelet en acier inox, acier style antique

	Ø cm	↑ cm	ltr.	Farbe / Colour	
93345	9	9	0,45		stainless-antique



**Becher „MOSCOW MULE“**

barrel copper mug  
taza  
gobelet



**Edelstahlbecher, Antik-Kupfer-Look**  
stainless steel cup, copper antique look  
taza de acero inoxidable, cobre estilo antiguo  
gobelet en acier inox, cuivre style antique

	Ø cm	↑ cm	ltr.	Farbe / Colour	
93322	9	9	0,45		copper-antique



**Becher „MOSCOW MULE“**

barrel copper mug  
taza  
gobelet



**Edelstahlbecher, Kupfer-Look, glänzend**  
stainless steel cup, copper look, highshine  
taza de acero inoxidable, cobre, brillante  
gobelet en acier inox, cuivre, brillant

	Ø cm	↑ cm	ltr.	Farbe / Colour	
93310	9	9	0,45		copper-look



**Becher „MOSCOW MULE“**

barrel copper mug  
taza  
gobelet



**Edelstahlbecher, Kupfer-Look, glänzend**  
stainless steel cup, copper look, highshine  
taza de acero inoxidable, cobre, brillante  
gobelet en acier inox, cuivre, brillant

	Ø cm	↑ cm	ltr.	Farbe / Colour	
93311	9	10	0,50		copper-hammered



**Becher „MOSCOW MULE“**

barrel copper mug  
taza  
gobelet



**Edelstahlbecher, Antik-Kupfer-Look**  
stainless steel cup, copper look  
taza de acero inoxidable, cobre estilo antiguo  
gobelet en acier inox, cuivre style antique

	Ø cm	↑ cm	ltr.	Farbe / Colour	
93323	9	10	0,50		copper-antique-hammered





**Becher „MOSCOW MULE“**

barrel mug  
taza  
gobelet



**Edelstahlbecher, Antik-Edelstahl-Look**  
stainless steel cup, stainless antique look  
taza de acero inoxidable, acero estilo antiguo  
gobelet en acier inox, acier style antique

	Ø cm	↑ cm	ltr.	Farbe / Colour	
93333	9,5	10	0,50		stainless-antique



**Becher „MOSCOW MULE“**

barrel copper mug  
taza  
gobelet



**Edelstahlbecher, Antik-Kupfer-Look**  
stainless steel cup, copper antique look  
taza de acero inoxidable, cobre estilo antiguo  
gobelet en acier inox, cuivre style antique

	Ø cm	↑ cm	ltr.	Farbe / Colour	
93331	9,5	10	0,50		copper-antique



**Becher „MOSCOW MULE“**

barrel copper mug  
taza  
gobelet



**Edelstahlbecher, Kupfer-Look, glänzend**  
stainless steel cup, copper look, glossy  
taza de acero inoxidable, cobre, brillante  
gobelet en acier inox, cuivre, brillant

	Ø cm	↑ cm	ltr.	Farbe / Colour	
93332	9,5	10	0,50		copper-look



**Becher „MINI SHOT“, 4er-Set**

barrel mug 4 pcs.  
taza, set de 4  
gobelet, set de 4



	Ø cm	↑ cm	ltr.	Farbe / Colour	
93342	4,5	4,5	0,05		copper-antique
93343	4,5	4,5	0,05		copper-look
93344	4,5	4,5	0,05		stainless-antique



**Becher „COCKTAIL MUG“**

barrel  
taza  
gobelet



	Ø cm	↑ cm	ltr.	Farbe / Colour	
93370	8,5	14	0,5		stainless





**Becher „COOL“**

barrel mug  
taza  
gobelet



**Edelstahlbecher, Kupfer-Look, glänzend**  
stainless steel cup, copper look, glossy  
taza de acero inoxidable, estilo cobre, brillante  
gobelet en acier inox, aspect cuivre, brillant

	Ø cm	↑ cm	ltr.	Farbe / Colour	
93371	7,5	10,5	0,35		copper-look



**Becher „COOL“**

barrel mug  
taza  
gobelet



**Edelstahlbecher, Gunmetal-Look, glänzend**  
stainless steel cup, gunmetal look, glossy  
taza de acero inoxidable, estilo gunmetal, brillante  
gobelet en acier inox, aspect gunmetal, brillant

	Ø cm	↑ cm	ltr.	Farbe / Colour	
93372	7,5	10,5	0,35		gunmetal-look



**Becher „COOL“**

barrel mug  
taza  
gobelet



**Edelstahlbecher, Antik-Edelstahl-Look**  
stainless steel cup, stainless antique look  
taza de acero inoxidable, acero estilo antiguo  
gobelet en acier inox, acier style antique

	Ø cm	↑ cm	ltr.	Farbe / Colour	
93373	7,5	10,5	0,35		stainless-antique



**Becher „COOL“**

barrel mug  
taza  
gobelet



**Edelstahlbecher, Regenbogen-Look**  
stainless steel cup, rainbow look  
taza de acero inoxidable, estilo arco iris  
gobelet en acier inox, look arc-en-ciel

	Ø cm	↑ cm	ltr.	Farbe / Colour	
93374	7,5	10,5	0,35		rainbow-look



**Becher „BEER MUG“**

barrel mug  
taza  
gobelet



	Ø cm	↑ cm	ltr.	Farbe / Colour	
93364	8,5	13	0,50		copper-antique
93365	8,5	13	0,50		stainless-antique



Becher „PINEAPPLE“

barrel mug  
taza  
gobelet



Glasbecher mit Edelstahl Deckel  
glass cup with stainless steel lid  
taza de cristal con tapa en acero inoxidable  
gobelet en verre avec couvercle en acier inox

	Ø cm	↑ cm	ltr.
93375	8,5	17,5	0,35



Becher „PINEAPPLE“

barrel mug  
taza  
gobelet



Edelstahlbecher, Kupfer-Look  
stainless steel cup, copper look  
taza de acero inoxidable, cobre  
gobelet en acier inox, cuivre

	Ø cm	↑ cm	ltr.	Farbe / Colour
93334	9	19	0,5	copper-look



Becher „PINEAPPLE“

barrel mug  
taza  
gobelet



Edelstahlbecher, Gold-Look  
stainless steel cup, gold look  
taza de acero inoxidable, dorada  
gobelet en acier inox, doré

	Ø cm	↑ cm	ltr.	Farbe / Colour
93335	9	19	0,5	gold-look



Gläserchiene

glass rack  
rack de copas  
rack porte-verres



aus 6 mm Draht, Metall verchromt, Wand- und Deckenmontage möglich  
6 mm chrome plated wire, can be mounted under a shelf or on the wall  
alambre cromado de 6 mm, puede instalarse bajo una estantería o en la pared  
fil chromé de 6 mm, à installer sous une étagère ou contre un mur

	cm	↑ cm	for glasses	Farbe / Colour
93398	29,5 x 32	6	12	chrome
93399	29,5 x 32	6	12	black
93400	45,0 x 32	6	20	chrome



# JULEP MUG



**Becher „JULEP MUG“**  
barrel mug  
taza  
gobelet



	Ø cm	↑ cm	ltr.	Farbe / Colour
93336	8	11,5	0,40	 copper-antique-hammered
93337	8	11,5	0,40	 copper-hammered
93338	8	11,5	0,40	 stainless-antique-hammered



**Becher „JULEP MUG“**  
barrel mug  
taza  
gobelet



	Ø cm	↑ cm	ltr.	Farbe / Colour
93327	8,5	10	0,35	 copper-antique
93328	8,5	10	0,35	 copper-look
93329	8,5	10	0,35	 stainless



NEW

# Mini Feuerzangen-Set's

Zuckerhut / sugar cones



inkl. 50 Stk.  
incl. 50 pcs.

6 Stk.  
6 pcs.



## Mini Feuerzangen-Set I

mini fire punch bowl set  
mini set para ponche caliente  
mini set pour punch



bestehend aus:

6 Mini Feuerzangen / 50 Mini Zuckerhüte

consisting of:

6 mini fire tongs / 50 mini sugar cones

compuesto por:

6 mini pinzas para el fuego / 50 mini conos de azúcar

composé de:

6 mini-pinces à feu / 50 mini-cônes à sucre

	cm	↑ cm
65070	14,5 x 3,5	1,5

Zuckerhut / sugar cones



inkl. 50 Stk.  
incl. 50 pcs.

2 Stk.  
2 pcs.



2 Stk.  
2 pcs.



## Mini Feuerzangen-Set II

mini fire punch bowl set  
mini set para ponche caliente  
mini set pour punch



bestehend aus:

2 Edelstahlbecher, Kupfer-Look / 2 Mini Feuerzangen / 50 Mini Zuckerhüte

consisting of:

2 stainless steel cups, copper look / 2 mini fire tongs / 50 mini sugar cones

compuesto por:

2 tazas de acero inoxidable, cobre / 2 mini pinzas para el fuego / 50 mini conos de azúcar

composé de:

2 tasses en acier inox, cuivre / 2 mini-pinces à feu / 50 mini-cônes à sucre

	Ø cm	↑ cm	litr.
65071	9	9	0,45





**Mini Feuerzangen-Set III**  
mini fire punch bowl set  
mini set para ponche caliente  
mini set pour punch



bestehend aus:  
2 Edelstahlbecher, Kupfer-Look / 2 Mini Feuerzangen / 50 Mini Zuckerhüte  
consisting of:  
2 stainless steel cups, copper look / 2 mini fire tongs / 50 mini sugar cones  
compuesto por:  
2 tazas de acero inoxidable, cobre / 2 mini pinzas para el fuego / 50 mini conos de azúcar  
composé de:  
2 tasses en acier inox, cuivre / 2 mini-pinces à feu / 50 mini-cônes à sucre

	Ø cm	↑ cm	ltr.
65072	9	10	0,5



**Fondue und Feuerzangenbowl-Set „TWO IN ONE“**  
fondue and fire punch bowl set  
set para fondue o ponche caliente  
service à fondue et à punch



13-teiliges Set aus Edelstahl bestehend aus:  
1 Topf, 1 Rechaud, 1 Spritzschutz, 1 Untersetzer, 1 Schöpfkelle, 1 Feuerzange,  
1 Pastenbrenner, 6 Fonduegabeln

13-piece stainless steel set consisting of:  
1 pot, 1 rechaud, 1 splash guard, 1 coaster, 1 ladle, 1 fire tongs,  
1 paste burner, 6 fondue forks

set de 13 piezas de acero inoxidable compuesto por:  
1 olla, 1 rechaud, 1 protector contra salpicaduras, 1 trébede, 1 cazo,  
1 pinza para el fuego, 1 quemador de pasta, 6 tenedores de fondue

set de 13 pièces en acier inox comprenant:  
1 marmite, 1 rechaud, 1 pare-éclaboussures, 1 dessous de plat, 1 louche, 1 pince à feu,  
1 brûleur à pâte, 6 fourchettes à fondue

	Ø cm	↑ cm	ltr.
65060	22	23	2,2



**Shaker „CLASSIC“**

shaker  
coctelera  
shaker



**Edelstahlbecher, hochglanzpoliert**  
stainless steel cup, mirror polished finish  
taza de acero, acabado pulido brillante  
gobelet en acier, brillant

	Ø cm	↑ cm	ltr.
36010	8,5	20	0,5
36011	9,0	23	0,7



**Shaker „CLASSIC“**

shaker  
coctelera  
shaker



**Edelstahlbecher, Kupfer-Look, glänzend**  
stainless steel cup, copper look, highshine  
taza de acero inoxidable, cobre, brillante  
gobelet en acier inox, cuivre, brillant

	Ø cm	↑ cm	ltr.	Farbe / Colour
93211	8,5	20	0,5	 copper-look
93212	9,0	23	0,7	 copper-look



**Shaker „CLASSIC“**

shaker  
coctelera  
shaker



**Edelstahlbecher**  
stainless steel cup  
taza de acero inoxidable  
gobelet en acier inox

	Ø cm	↑ cm	ltr.	Farbe / Colour
93366	9,0	23	0,7	 stainless-antique
93326	9,0	23	0,7	 copper-antique



**Parisian Shaker**

shaker  
coctelera  
shaker



**Edelstahlbecher, mattiert**  
stainless steel cup, satin polished finish  
taza de acero, acabado efecto satinado  
gobelet en acier, fini mat effet satin

	Ø cm	↑ cm	ltr.
93179	9,5	24	0,7



**Boston Shaker**

boston shaker  
coctelera boston  
shaker boston



2-teilig: Becher, 700 ml + Glas, 400 ml

2 pcs. set: beaker, 700 ml + glass, 400 ml

set de 2 piezas: vaso coctelero, 700 ml+ vaso vidrio 400 ml

2 pièces: bol mélangeur, 700 ml + bol en verre 400 ml

	Ø cm	↑ cm	ltr.	Farbe / Colour	
93140	9	30	0,70 / 0,40		stainless-steel
93350	9	30	0,70 / 0,40		stainless-antique

	Ø cm	↑ cm	ltr.	Farbe / Colour	
93325	9	30	0,70 / 0,40		copper-antique
93201	9	30	0,70 / 0,40		copper-look

Ersatzglas / spare glass / vaso de recambio / verre de rechange

	Ø cm	↑ cm	ltr.
93138	8,5	14,5	0,4

**Boston Shaker**

boston shaker  
coctelera boston  
shaker boston



2-teilig: Becher, 700 ml, gummiert, rutschfest + Glas, 400 ml

2 pcs. set: beaker, 700 ml, rubberized, anti-slip + glass, 400 ml

conjunto de 2 piezas: vaso coctelero con goma exterior 700 ml + vaso de vidrio 400 ml

2 pièces: bol mélangeur inox extérieur plastifié couleur 700 ml + bol en verre 400 ml

	Ø cm	↑ cm	ltr.	Farbe / Colour
93139	9	30	0,7	

Ersatzglas / spare glass / vaso de recambio / verre de rechange

	Ø cm	↑ cm	ltr.
93138	8,5	14,5	0,4



Barmaß  
jigger  
medidor jigger  
measure double jigger



	Ø cm	↑ cm	cl.	Farbe / Colour	
93351	4,5	9	2 / 4		stainless-steel-polished



Barmaß  
jigger  
medidor jigger  
measure double jigger



	Ø cm	↑ cm	cl.	Farbe / Colour	
93354	4,5	9	2 / 4		stainless-antique



Barmaß  
jigger  
medidor jigger  
measure double jigger



	Ø cm	↑ cm	cl.	Farbe / Colour	
93353	4,5	9	2 / 4		copper-look



Barmaß  
jigger  
medidor jigger  
measure double jigger





	Ø cm	↑ cm	cl.	Farbe / Colour	
93352	4,5	9	2 / 4		copper-antique





**Barmaß**  
jigger  
medidor  
measure double jigger

EDELSTAHL  
STAINLESS  
INOX 

	∅ cm	↑ cm	cl.	Farbe / Colour	
93164	4,5	9	1,5 / 2,5 / 3,5 / 5		stainless-steel-polished



**Barmaß**  
jigger  
medidor jigger  
measure double jigger

EDELSTAHL  
STAINLESS  
INOX 

	∅ cm	↑ cm	cl.	Farbe / Colour	
93355	4,0	11	1,5 / 2,5 / 3,5 / 5		stainless-antique



**Barmaß**  
jigger  
medidor jigger  
measure double jigger

EDELSTAHL  
STAINLESS  
INOX 

	∅ cm	↑ cm	cl.	Farbe / Colour	
93324	4	11	1,5 / 2,5 / 3,5 / 5		copper-antique



**Barmaß**  
jigger  
medidor jigger  
measure double jigger

EDELSTAHL  
STAINLESS  
INOX 

	∅ cm	↑ cm	cl.	Farbe / Colour	
93165	4	11	1,5 / 2,5 / 3,5 / 5		copper-look



**Barmaß**  
jigger  
medidor jigger  
measure double jigger



hochglanzpoliert, schnelles und genaues Abmessen von Spirituosen  
mirror polished finish, quick and exact measuring of spirits  
pulido brillante, medida rápida y exacta de licores  
poli miroir, mesure exact et rapide des spiritueux

	Ø cm	↑ cm	cl
93116	6 / 5	6	2 / 4



**Barmaß**  
jigger  
medidor jigger  
measure double jigger



	Ø cm	↑ cm	cl
93120	4,5 / 3,5	7,0	2 / 4



**Barmaß**  
jigger  
medidor jigger  
measure double jigger



	Ø cm	↑ cm	cl
93121	4,0 / 3,5	8,5	2 / 4
93112	4,5 / 4,0	8,5	2,5 / 5



**Barmaß**  
jigger  
medidor jigger  
measure double jigger



hochglanzpoliert, schnelles und genaues Abmessen von Spirituosen  
mirror polished finish, quick and exact measuring of spirits  
pulido brillante, medida rápida y exacta de licores  
poli miroir, mesure exact et rapide des spiritueux

	Ø cm	↑ cm	cl.
93357	3,5	7,5	3 / 5



**Barmaß**  
jigger  
medidor jigger  
measure double jigger



hochglanzpoliert, schnelles und genaues Abmessen von Spirituosen  
mirror polished finish, quick and exact measuring of spirits  
pulido brillante, medida rápida y exacta de licores  
poli miroir, mesure exact et rapide des spiritueux

	Ø cm	↑ cm	cl.
93356	5	9	1 / 1,5 / 2 / 3 / 4 / 6

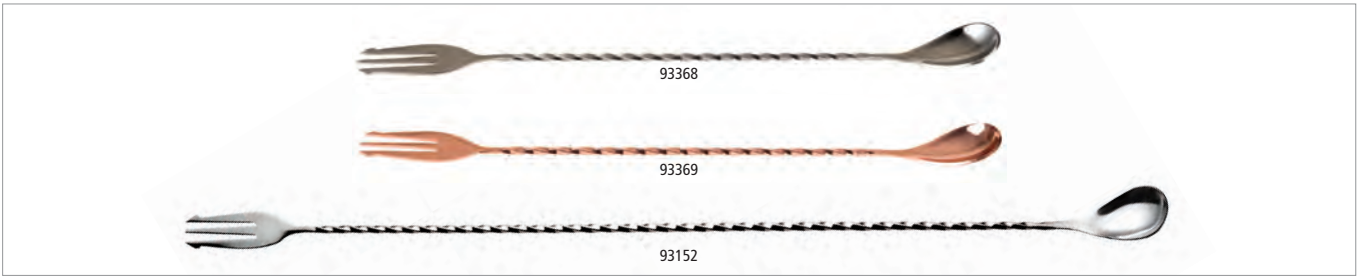

**Barlöffel / -gabel**  
 bar spoon  
 cucharilla de cóctel trident  
 cuillère de bar trident

EDELSTAHL  
 STAINLESS  
 INOX

	→ cm	Farbe / Colour	
93368	30		stainless steel
93369	30		copper-look
93152	50		stainless steel

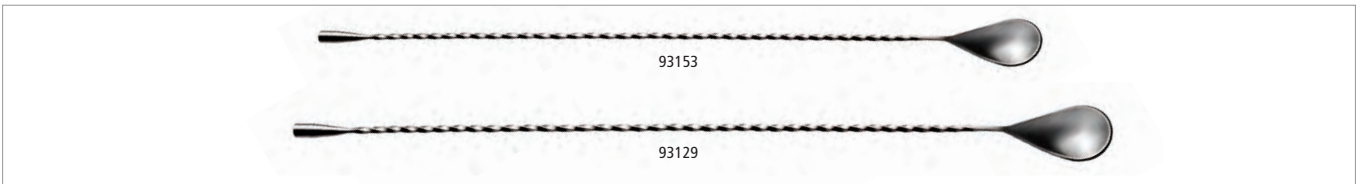

**Barlöffel**  
 bar spoon  
 cucharilla de cóctel  
 cuillère à cocktail

EDELSTAHL  
 STAINLESS  
 INOX

	→ cm
93153	40
93129	44

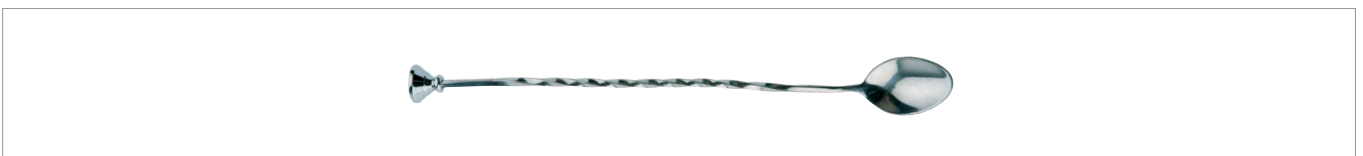

**Barlöffel**  
 bar spoon  
 cucharilla de cóctel  
 cuillère à cocktail

EDELSTAHL  
 STAINLESS  
 INOX

	→ cm
93134	27



**Barlöffel**  
 bar spoon  
 cucharilla de cóctel  
 cuillère à cocktail

EDELSTAHL  
 STAINLESS  
 INOX

	→ cm	Farbe / Colour	
93034	27		copper-look

hot price



**Barsieb**

bar strainer  
colador de cóctel  
tamis cocktail



hochglanzpoliert, Spiralfeder hält Eiswürfel beim Abseihen zurück, Feder kann zur Reinigung entnommen werden, passend für alle Gläser und Shaker  
mirror polished finish, coil spring keeps ice cubes in shaker, spring can be taken off for cleaning, suitable for all glasses and shakers  
con muelle para mantener los cubitos en la coctelera, el muelle se desmonta para limpiar, se adapta a todos los tipos de vasos y cocteleras  
brillant, avec ressort pour garder les glaçons dans le shaker, ressort démontable pour lavage, s'adapte à tous types de verres mélangeurs et shakers

	Ø cm	Griff / handle cm	→ Ø cm
93300	8	6	mit Auflage-Örchen 12



**Einhandgebrauch**  
handed use

**Julep Barsieb „PRO“**

julep strainer  
colador de cóctel  
tamis cocktail



hochglanzpoliert  
mirror polished finish  
acabado pulido brillante  
fini poli brillant

	Ø cm	Griff / handle cm
93313	7,5	9



**Barsieb**

bar strainer  
colador de cóctel  
tamis cocktail



Spiralfeder hält Eiswürfel beim Abseihen zurück, Feder kann zur Reinigung entnommen werden, passend für alle Gläser und Shaker

coil spring keeps ice cubes in shaker, spring can be taken off for cleaning, suitable for all glasses and shakers  
con muelle para mantener los cubitos en la coctelera, el muelle se desmonta para limpiar, se adapta a todos los tipos de vasos y cocteleras  
avec ressort pour garder les glaçons dans le shaker, ressort démontable pour lavage, s'adapte à tous types de verres mélangeurs et shakers

	Ø cm	Griff / handle cm	Farbe / Colour
93347	9	9	copper-antique
93348	9	9	copper-look
93349	9	9	stainless-antique
93312	9	9	stainless



**Einhandgebrauch**  
single-handed use





**Stößel**  
muddler  
mortero  
pilon muddler



**zum Auspressen von Früchten und Zerstoßen von Würfelzucker**

to press fruits or pound lump sugar  
para exprimir frutas y machacar azucarillos  
pour presser les fruits ou le sucre en morceaux

	∅ cm	→ cm
93188	4	28



**Stößel**  
muddler  
mortero  
pilon muddler



**mit griffigem Ende, zum Auspressen von Früchten und Zerstoßen von Würfelzucker**

with handy end, to press fruits or pound lump sugar  
acabado relieve para prensar frutas o azucar  
avec relief grillagé pour presser les fruits ou le sucre en morceaux

	∅ cm	→ cm	Farbe / Colour
93180	2,5	21	



**Stößel**  
muddler  
mortero  
pilon muddler



**mit griffigem Ende, zum Auspressen von Früchten und Zerstoßen von Würfelzucker**

with handy end, to press fruits or pound lump sugar  
con un acabado en relieve para exprimir frutas y machacar azucarillos  
avec relief grillagé pour presser les fruits ou le sucre en morceaux

	∅ cm	→ cm	Farbe / Colour	€
93362	3,5	20,5	antique-copper-look	
93358	3,5	20,5	stainless steel	
93360	3,5	20,5	copper-look	
93361	3,5	20,5	stainless-antique look	



**Stößel**  
muddler  
mortero  
pilon muddler



**grober Stößel, zum Auspressen von Früchten und Zerstoßen von Würfelzucker**

coarse notched, to press fruits or pound lump sugar  
mortero grueso con muescas para exprimir frutas y machacar azucarillos  
muddler grand format avec bout relief étoile pour presser les fruits ou le sucre en morceaux

	∅ cm	→ cm	Farbe / Colour
93181	2,5	21	
93182	4	24	



**Barsieb**  
bar strainer  
colador de cóctel  
tamis cocktail



	Ø cm	→ cm
93318	8,5	11,5



**Schneidebrett „BAR“**  
cutting board  
table de corte  
planche à découper



**HDPE, mit Safrinne, mit Antirutsch-Füßchen**  
HDPE, with juice groove and non-slip feet  
HDPE, con ranura para líquidos y pies antideslizantes  
HDPE, avec rigole et pieds antidérapants

	cm	↑ cm
93306	30 x 20	2
93307	50 x 30	2



**Zitruspresse**  
citrus squeezer  
exprimidor cítricos  
presse-citron



**hochglanzpoliert, 2-teilig**  
mirror polished finish, 2 pcs.  
pulido brillante, 2 piezas  
brillant, 2 pièces

	Ø cm	↑ cm	ltr.
71431	12 / 17	10,5	0,35



**Cocktailmesser „ORANGE“**  
bar knife  
cuchillo para cóctel  
couteau cocktail



**mit 2 Zinken zum Aufspießen von Zitrusseiben**  
with 2 prongs to pick up slices of lemon  
con 2 dientes para pinchar las rodajas de limón, etc.  
avec 2 dents pour les rondelles de citron et autres décorations

	→ cm
88846	21



**Dekoriermesser „ORANGE“**  
decorating knife „canelé“  
cuchillo acanalador  
couteau cannelé



**gezahnte Klinge aus geschärftem Edelstahl**  
serrated sharpened blade, stainless steel  
hoja de sierra afilada, acero inoxidable  
lame inox microdentée

	→ cm
88843	19



2 Pressringe für Zitrone und Limette

**Limetten- / Zitronenpresse**  
lime- / lemonpress  
exprimidor de limón / lima  
presse citron



	cm	↑ cm
93214	21 x 7	5



**Limettenpresse**  
lime press  
prensa de limón  
presse citron



	cm	↑ cm
93189	21 x 7	5



1,3 ltr.

**Eiseimer-Set mit Eiszange**  
ice bucket set with tong  
cubitera clásica con pinza  
seau à glaçons classique avec pince



mit Abtropfgitter, isolierter Kunststoffeinsatz, Zange lässt sich im Deckel verstauen, für max. 50 Eiswürfel, hält die Eiswürfel bis zu 5 Stunden in ihrer Form

with drainer, insulated plastic insert, tongs can be stored in the lid, for max. 50 ice cubes, keeps the ice cubes in shape for up to 5 hours

con escurridor, inserto de plástico aislado, la pinza se puede guardar en la tapa, para un máximo de 50 cubitos de hielo, mantiene los cubitos de hielo en forma hasta 5 horas

avec égouttoir, insert en plastique isolé, la pince peut être rangée dans le couvercle, pour max. 50 glaçons, maintient les glaçons dans leur forme jusqu'à 5 heures

	Ø cm	↑ cm	ltr.
36015	14	22	1,3



1,0 ltr.

**Eiseimer-Set mit Eiszange**  
ice bucket set with tong  
cubitera clásica con pinza  
seau à glaçons classique avec pince



für max. 45 Eiswürfel, hält die Eiswürfel bis zu 5 Stunden in ihrer Form

max. 45 ice cubes, keeps the ice cubes in shape for up to 5 hours

para un máximo de 45 cubitos de hielo, mantiene los cubitos de hielo en forma hasta 5 horas

pour max. 45 glaçons, maintient les glaçons dans leur forme jusqu'à 5 heures

	Ø cm	↑ cm	ltr.
36013	12	14	1



**Eisbox**  
icebox  
cubitera  
seau à glaçons



**herausnehmbarer Innenbehälter dient als Tropfeinsatz, hält bis zu 5 Stunden die Eiswürfel in ihrer Form**

removable inner container serves as drainer, keeps the ice cubes in shape for up to 5 hours

contenedor interior extraíble sirve como inserto de goteo, mantiene los cubitos de hielo en forma hasta 5 horas

réceptier intérieur amovible sert d'égouttoir, maintient les glaçons dans leur forme jusqu'à 5 heures

	Ø cm	↑ cm	ltr.	
36033	18,5	20	3	max. 150 ice cubes
36037	27	20	6	max. 300 ice cubes



**Eisbox**  
icebox  
cubitera  
seau à glaçons



**herausnehmbarer Innenbehälter dient als Tropfeinsatz, für max. 150 Eiswürfel, hält bis zu 5 Stunden die Eiswürfel in ihrer Form**

removable inner container serves as drainer, for max. 150 ice cubes, keeps the ice cubes in shape for up to 5 hours

contenedor interior extraíble sirve como inserto de goteo, para un máximo de 150 cubitos de hielo, mantiene los cubitos de hielo en forma hasta 5 horas

réceptier intérieur amovible sert d'égouttoir, pour max. 150 glaçons, maintient les glaçons dans leur forme jusqu'à 5 heures

	cm	↑ cm	ltr.	
93200	20 x 20	17	3,4	max. 150 ice cubes



**Eisbox**  
icebox  
cubitera  
seau à glaçons



**herausnehmbarer Innenbehälter dient als Tropfeinsatz, für max. 300 Eiswürfel, hält die Eiswürfel bis zu 5 Stunden in ihrer Form**

removable inner container serves as drainer, for max. 150 ice cubes, ice bucket keeps the ice cubes in shape for up to 5 hours

contenedor interior extraíble sirve como inserto de goteo, para un máximo de 150 cubitos de hielo, mantiene los cubitos de hielo en forma hasta 5 horas

réceptier intérieur amovible sert d'égouttoir, pour max. 150 glaçons, maintient les glaçons dans leur forme jusqu'à 5 heures

	Ø cm	↑ cm	ltr.	
93220	27 x 27	15	5	max. 300 ice cubes



**Kühlbox „FROSTY“**  
bottle cooler  
enfriador de botellas  
rafraichisseur de bouteilles



**mit herausnehmbarem Einsatz für 4 Flaschen**

with removable insert for 4 bottles

con inserto extraíble para 4 botellas

avec insert amovible pour 4 bouteilles



**Abb. ohne Einsatz**  
illustration without insert

	cm	↑ cm	ltr.	Ø holes cm
93230	27 x 27	15	7,5	11





**Eisschaufel**  
ice scoop  
pala de hielo  
pelle à glaçons



	cm	→ cm	ltr.
93192	10 x 6	29	0,7



**Eisschaufel**  
ice scoop  
pala de hielo  
pelle à glaçons



**gelocht, ideal zum Befüllen von schlanken Gläsern**  
perforated, ideal to fill narrow glasses  
perforada, ideal para llenar vasos estrechos  
perforée, idéale pour verser les glaçons dans des verres étroits

	Ø cm	→ cm
93191	5	19,5



**Glasumrander**  
glass rimmer  
ribeteador de vasos  
bordeur à verres „rimmer“



**Schwamm für Limettensaft, 2 Fächer für Zucker und Salz**  
with sponge for lime juice, 2 cases for sugar and salt  
con esponja para zumo de lima, 2 compartimentos para azucar y sal  
avec éponge et 2 compartiments pour sucre et sel

	cm
93175	20 x 7,5



**Eis-Kugel-Former**  
ice ball former  
molde de cubitos de hielo esféricos  
moule à glaçons en boules



**2 tlg., 3 Kugeln à 100 ml, einfach mit Wasser füllen und gefrieren lassen**  
3 bowls à 100 ml, simply fill with water and allow to freeze  
3 bolas de 100 ml, simplemente llenar con agua y dejar congelar  
3 boules à 100 ml, simplement remplir avec de l'eau et mettre à congeler

	cm	↑ cm
12990	23,5 x 8,5	6,5



**Eiszerkleinerer**  
Ice crusher  
picadora de hielo  
broyeur à glaçons



**glasklar, mit Edelstahl-Messer**  
clear, stainless steel cutters  
cuchillas de acero inoxidable  
couteaux inox

	cm	↑ cm
36017	12 x 12	24



**Pinzettenzange**

fine tong / tweezer  
pinza de emplatar  
pince à dresser



hochglanzpoliert, geriffelte Grifffläche, schwere Qualität  
mirror polished finish, ribbed handle, heavy gauge  
acabado brillante, mango cómodo ranurado, alta calidad  
brillant, manche rainuré antiglisse, qualité extra

→ cm

75820

16



**Pinzettenzange**

fine tong / tweezer  
pinza de emplatar  
pince à dresser



hochglanzpoliert, geriffelte Grifffläche, schwere Qualität  
mirror polished finish, ribbed handle, heavy gauge  
acabado brillante, mango cómodo ranurado, alta calidad  
brillant, manche rainuré antiglisse, qualité extra

→ cm

75821

30



**Eiszange**

ice cube tong  
pinza para cubitos de hielo  
pince à glaçons



hochglanzpoliert, fugenlos  
mirror polished finish, seamless  
pulido acabado brillante, de una sola pieza  
brillant, d'une seule pièce

cm

→ cm

75805

5 x 2

17,5



**Eiszange**

ice tong  
pinza para cubitos de hielo  
pince à glaçons



matt poliert, mit griffigem Ende, ideal für Eiswürfel und Obstscheiben  
satin polished finish, with handy end, ideal for ice cubes and fruit slices  
pulido satinado, forma ergonómica ideal para cubitos de hielo y láminas de fruta  
poli mat satiné, forme ergonomique idéale pour glaçons et fruits tranchés

cm

→ cm

93190

2 x 1,5

20



**Reinigungsbürste für Ausgießer**

pourer cleaning brush  
cepillo de limpieza para picos vertedores  
brosse lave-bouchons doseurs



→ cm

93102

16,5



**Trinkhalme 11er Set**

straws, 11 pcs. set  
pajas, set de 11 pz.  
pailles, set de 11 pc.



**11-teiliges Set: 10 Trinkhalme aus Edelstahl + Reinigungsbürste**

11 pcs. set: 10 drinking straws made of stainless steel + cleaning brush  
set de 11: 10 pajas de acero inoxidable + cepillo de limpieza  
set de 11: 10 pailles en acier inox + brosse de nettoyage

	Ø mm	→ cm	Farbe / Colour	
93391	8	15,0		copper-look
93392	8	15,0		gunmetal-look
93393	8	15,0		rainbow-look
93380	6	21,5		copper-look
93381	6	21,5		gunmetal-look
93382	6	21,5		rainbow-look
93383	8	21,5		copper-look
93384	8	21,5		gunmetal-look
93385	8	21,5		rainbow-look

**Ersatzbürste / replacement brush / cepillo de recambio / brosse de rechange**

	Ø mm	→ cm
93395	8	15
93386	8	20



**Trinkhalme 7er Set**

straws, 7 pcs. set  
pajas, set de 7 pz.  
pailles, set de 7 pc.



	Ø mm	→ cm	pcs.
93394	10	15	7
93390	10	21	7





**Barmatte**

drip mat  
tapete escurridor  
tapis de bar

aus weichem Kunststoff, zum Abtropfen von Gläsern etc.  
soft plastic, to store and drain glasses  
plástico blando para escurrir vasos  
plastique souple, pour l'égouttage des verres



	cm	↑ cm	Farbe / Colour	
93166	30 x 15	1	■	ohne Vertiefung
93167	45 x 31	1	■	ohne Vertiefung
93173	52 x 8	1	■	ohne Vertiefung
93168	60 x 8	1	■	mit Vertiefung
93169	60 x 8	1	■	ohne Vertiefung



**Abtropfmatte**

drip mat  
esterilla escurridora  
tapis égouttoir

gerollt  
rolled  
enrollada  
roulée



	cm	↑ cm	Farbe / Colour
93314	60 x 300	0,3	■
93315	60 x 300	0,3	■

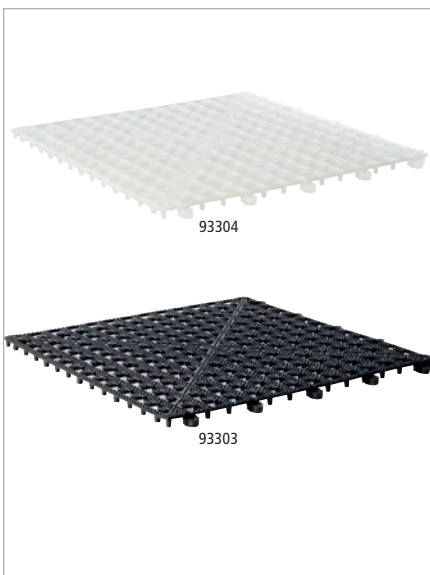

**Abtropfmatte**

drip mat  
esterilla escurridora  
tapis égouttoir

erweiterbar durch Klick-Verbindung  
expandable  
las placas de fijan con clips  
avec clips de fixation



	cm	↑ cm	Farbe / Colour
93304	33 x 33	1,5	■
93303	33 x 33	1,5	■







**Zutatenbehälter**  
condiment holder  
dispensador de especias  
boîte à fruits et ingrédients



500 ml Inhalt pro Fach, 6 Fächer, inkl. Deckel (gefrostet) zur Lagerung  
6 chambers á 500 ml, incl. lid for storing  
6 compartimentos de 500 ml., incluye tapa para el almacenaje  
6 compartiments de 500 ml chacun, avec couvercle pour le stockage

	cm	↑ cm
93171	50 x 16	10



**Bar-Caddy**  
bar caddy  
organizador de bar  
organisateur „bar caddy“



Ordnungshilfe für Trinkhalme, Rührer, Servietten, Streichhölzer, etc.  
to organize straws, stirrers, napkins, matches, etc.  
para organizar pajitas, cucharillas, servilletas, cerillas, etc.  
pour bien organiser les pailles, agitateurs, cuillers, serviettes et autres accessoires

	cm	↑ cm
93174	24 x 15	11



**Getränkspender „OLD FASHIONED“**  
beverage dispenser  
dispensador de bebidas  
distributeur de boissons



dicke, stabile Wände, weite Öffnung für große Zutaten, Gestell schwarz  
thick, stable walls, a wide opening for large ingredients, black stand  
tiene paredes gruesas y estables, amplia abertura para ingredientes grandes, soporte negro  
des murs épais et stables, large ouverture pour de grands ingrédients, support noir

	Ø cm	↑ cm	litr.
10409	24,5	50,5	7
			inkl. Gestell / incl. stand



**Getränkspender „FRUITS“**  
beverage dispenser  
dispensador de bebidas  
distributeur de boissons



dicke, stabile Wände, weite Öffnung für große Zutaten, Gestell schwarz  
thick, stable walls, a wide opening for large ingredients, black stand  
tiene paredes gruesas y estables, amplia abertura para ingredientes grandes, soporte negro  
des murs épais et stables, large ouverture pour de grands ingrédients, support noir

	Ø cm	↑ cm	litr.
10415	25	58	10,5
			inkl. Gestell / incl. stand



**Flaschenkühler „CONFERENCE“**

conference bottle cooler  
enfriador múltiple  
rafraîchisseur



inkl. Kühllakku, Flaschenöffner, Kronkorkenschale,  
mit 6 Öffnungen Ø 6,7 cm für 0,25 - 0,5 Liter-Flaschen

incl. bottle cooler, bottle opener, small cap bowl,  
with 6 holes Ø 6,7 cm for 0,25 to 0,5 liter bottles

con acumulador de frío, abridor, recuperador de chapas,  
6 plazas Ø 6,7 cm, para botellas de 25 a 50 cl

avec accumulateur de froid, décapsuleur, bol récupérateur  
de capsules, 6 places Ø 6,7 cm, pour bouteilles de 25 à 50 cl

	Ø cm	↑ cm	Farbe / Colour
00620	23	15	■
00621	23	15	■

**Kühllakku / cooler / acumulador de frío / accumulateur de froid**

	Ø cm	↑ cm	Farbe / Colour
00616	7,5	11,5	■
00615	7,5	11,5	■

**Kronkorkenschale / cap bowl / cuenco para chapas / bol récupérateur de capsules**

	Ø cm	↑ cm	Farbe / Colour
00618	6,5	3	■
00619	6,5	3	■

**Flaschenöffner / bottle opener / abridor / décapsuleur**

	Ø cm	→ cm
00617	1	13,5



**Staubkappen, 2er Set**

dust & fly cap, 2 pcs.  
tapón antipolvo  
bouchon anti-poussières et anti-insectes  
schützt vor Staub und Insekten  
protects for dust and insects  
para proteger de la suciedad e insectos  
pour protéger de la poussière et des insectes



	Ø cm	↑ cm	pcs.	Farbe / Colour
93161	4	8	2	■



**Schlüsselschnur, 2er Set**

key cord, 2 pcs.  
llavero enrollable  
porte-clés avec câble à enroulement  
Befestigung mit Klammer am Gürtel, starke Rückzugfeder  
to fix at waistbelt, strong pull-back spring  
se fija en el cinturón, cable retrocede automáticamente  
à fixer à la ceinture, enroulage automatique



	Ø cm	↑ cm
93170	4	2



**Dosier- & Vorratsflasche**

pouring container  
botella „store & pour“  
bouteille „store & pour“



4-teilig: Behälter + Flaschenhals + Schraubdeckel + Ausgießer Ø 11 mm mit Luftzufuhr für gezieltes Ausgießen, zum Dosieren und Aufbewahren

4 pcs. set: for storage, mixing and serving drinks, nozzle Ø 11 mm

set de 4 piezas: para almacenar y servir mezclas y bebidas, agujero de Ø 11 mm

se compose de 4 pièces: idéal pour servir et pour conserver les boissons, embout Ø 11 mm

	Ø cm	↑ cm	ltr.	Farbe / Colour
93144	9	33	0,85	
93145	9	33	0,85	
93146	9	33	0,85	
93147	9	33	0,85	
93148	9	33	0,85	



abnehmbarer Boden dient als Deckel

removable bottom serves as a lid



**Spritzflasche inklusive Ausgießer**

squeeze bottle with nozzle  
botella exprimible con dosificador  
flacon pulvérisateur avec bec verseur



ideal für Bitter-Liköre, Essig, Öl

perfect for bitter liqueur, vinegar, oil

perfecto para amargo licor, vinagre, aceite

pour amaro liqueur, vinaigre, huile

	cm	↑ cm	ltr.
93308	6 x 5	20	0,2

Ausgießer passend für Spritzflasche / nozzle suitable for squeeze bottle / dosificador apto para botella exprimible / bec verseur approprié pour flacon pulvérisateur

	Ø cm	↑ cm
93309	2,5	5,5



**Rührglas mit Lippe**

mixing glass with lip  
vaso mezclador vertedor con pico  
verre mélangeur avec bec verseur



schwere Qualität

heavy quality

alta calidad

qualité renforcée

	Ø cm	↑ cm	ltr.	VE
93101	11,5	19	1	12



1:1 Oberflächenansicht  
1:1 structural view

**Rührglas mit Lippe**

mixing glass with lip  
vaso mezclador vertedor con pico  
verre mélangeur avec bec verseur



	Ø cm	↑ cm	ltr.
93141	9	16	0,50



**Permanent-Ausgießer, 6er Set**  
 free flow pourer, 6 pcs.  
 vertedor continuos set 6 piezas  
 set de 6 bouchons verseurs continus

à 2 Stück: blau, rot, gelb  
 2 pcs of each colour: blue, red, yellow  
 2 piezas de cada color: azul, rojo, amarillo  
 2 par couleur: bleu, rouge, jaune



	Ø cm	↑ cm	pcs.
93111	3	7,5	6



**Permanent-Ausgießer, 6er Set**  
 free flow pourer, 6 pcs.  
 vertedor continuos set 6 piezas  
 set de 6 bouchons verseurs continus



	↑ cm	pcs.
93110	11	6



**Ausgießer, 2er Set**  
 pourers, 2 pcs.  
 vertedores set 2 piezas  
 set de 2 bouchons verseurs

**Portionierer 2 cl, schnelles und genaues Abmessen**  
 2 cl, quick and exact measuring  
 2 cl. medición rápida exacta  
 2 cl mesure exacte et rapide



	↑ cm	pcs.
93115	10	2



**Permanent-Ausgießer, 6er Set**  
 free flow pourer, 6 pcs.  
 vertedor continuos set 6 piezas  
 set de 6 bouchons verseurs continus



	↑ cm	pcs.
93114	8	6



**Sekt-Verschluss, 2er Set**  
 stopper, 2 pcs.  
 set de 2 tapones  
 set de 2 bouchons

**matt poliert, innen Gummi Arabicum**  
 satin polished finish, inside rubber arabicum, with inscription  
 acabado pulido mate, interior goma arábica con inscripción  
 poli mat satiné, intérieur gomme arabique



	Ø cm	↑ cm	pcs.
93160	4	5,5	2





Eiswürfel 4 x 4 x 4 cm

**Eiswürfelform mit Deckel, 2er Set**

ice cube maker with lid, 2 pcs.  
molde para cubitos de hielo con tapa, set de 2  
moule à glaçons avec couvercle, set de 2



2 Eiswürfelformen für je 9 Stk. Eiswürfel, aus BPA freiem Silikon  
2 ice cube moulds for 9 ice cubes each, made of BPA free silicone  
2 moldes de cubitos de hielo para 9 cubitos cada uno, fabricados en silicona sin BPA  
2 moules à glaçons pour 9 glaçons chacun, fabriqué en silicone sans BPA

	cm	↑ cm	Eiswürfel
36102	15,5 x 15,5	5,5	4 x 4 x 4



Die Eiswürfel lassen sich leicht auslösen  
the ice cubes are easy to release



Eiswürfel 4 x 2,5 x 3 cm

**Eiswürfelform mit Deckel, 2er Set**

ice cube maker with lid, 2 pcs.  
molde para cubitos de hielo con tapa, set de 2  
moule à glaçons avec couvercle, set de 2



2 Eiswürfelformen für je 21 Stk. Eiswürfel  
2 ice cube moulds for 21 ice cubes each  
2 moldes de cubitos de hielo para 21 cubitos cada uno  
2 moules à glaçons pour 21 glaçons chacun

	cm	↑ cm	Eiswürfel
36103	25 x 15	4	4 x 2,5 x 3





**Kellnermesser „PROFI“**

waiter's corkscrew  
sacacorchos de camarero  
tire-bouchons



leichtgängige Teflon-Spirale, mehrstufige Klapphebelfunktion, am Fuß angebrachtes Messer  
easy moving teflon coil, 2-stage opening system, knife at the bottom end  
mecha de teflón, sistema de apertura en 2 golpes, con cuchillo en la parte superior  
mèche téflon, ouverture en 2 étapes, couteau dans la partie supérieure

	→ cm	
93302		11,5



**Kellnermesser**

waiter's corkscrew  
sacacorchos de camarero  
tire-bouchons



leichtgängige Teflon-Spirale, mehrstufige Klapphebelfunktion, am Kopf angebrachtes Messer  
easy moving teflon coil, 2-stage opening system, knife at the top end  
mecha de teflón, sistema de apertura en 2 golpes, con cuchilla en la parte superior  
mèche téflon, ouverture en 2 étapes, couteau dans la partie supérieure

	→ cm	
93301		12



**Kellner-Flaschenöffner**

waiter's barblade  
abridor camarero  
décapsuleur



matt poliert / satin polished finish / pulido acabado mate / poli mat

	cm	→ cm	
93122	4		18
00617	Ø 1		13,5



**Kellner-Flaschenöffner**

waiter's barblade  
abridor camarero  
décapsuleur



mit Gummierung  
with rubber coating  
con revestimiento de goma  
avec revêtement en caoutchouc

	cm	
93125		11 x 4



**Kronkorkenöffner**

bottle cap opener  
abridor de chapas de pared  
décapsuleur mural



für die Wandmontage, aus massivem Metall  
for wall fastening, massive metal  
para fijación en la pared, metal macizo  
massif, à fixer au mur

	cm	↑ cm	
93124	7 x 8		3



**Allzweckgießer**

pourer  
bote vertedor universal  
pot verseur universel



für Honig, Kaffeesahne, etc., Schraubdeckel aus Edelstahl

for honey, cream, etc., cover stainless steel

para miel, crema, etc., tapa inoxidable

pour le miel, le lait, la crème, etc., couvercle inox

	Ø cm	↑ cm	ltr.
00765	8,5	13,5	0,3

Ersatzglasbehälter / spare glas-container / contenedor de repuesto / récipient verre de rechange

00768



**Zuckerdosierer**

sugar dispenser  
azucarero  
sucrier



Schraubdeckel aus Edelstahl

cover stainless steel

tapa inoxidable

couvercle inox

	Ø cm	↑ cm	ltr.
00766	8,5	15	0,3

Ersatzglasbehälter / spare glas-container / contenedor de repuesto / récipient verre de rechange

00768



**Zuckerdosierer**

sugar dispenser  
azucarero  
sucrier



Schraubdeckel aus Edelstahl, mit Dosierrohr

cover stainless steel with dosingtube

tapa inoxidable y tubo dosificador

couvercle inox et tube doseur

	Ø cm	↑ cm	ltr.
40490	8,5	12	0,15
40494	8,0	15	0,25

Ersatzglasbehälter / spare glas-container / contenedor de repuesto / récipient verre de rechange

fits to

40498	40490
40499	40494



200 ml

**Zuckerdosierer**

sugar dispenser  
azucarero  
sucrier



**Schraubdeckel aus Edelstahl, mit Dosierrohr**  
cover stainless steel, with dosing tube  
tapa inoxidable y tubo, con cierre dosificador  
couvercle inox et tube doseur

	Ø cm	↑ cm	ltr.
40509	6	14,5	0,2



250 ml

**Allzweckgießer**

pourer  
dosificador  
doseur



**Schraubdeckel aus Edelstahl und Kunststoff, mit Dosierklappe**  
cover stainless steel and plastic, with dosing flap  
acero inoxidable y tapa plástico, con cierre dosificador  
couvercle en inox et plastique, avec couvercle doseure

	Ø cm	↑ cm	ltr.
40488	8	12,5	0,25



250 ml

**Zuckerdosierer**

sugar dispenser  
azucarero  
sucrier



**Schraubdeckel aus Edelstahl, mit Dosierrohr**  
cover stainless steel, with dosing tube  
tapa inoxidable y tubo, con cierre dosificador  
couvercle inox et tube doseur

	Ø cm	↑ cm	ltr.
40486	8	15	0,25



320 ml

**Zuckerdosierer**

sugar dispenser  
azucarero  
sucrier



**Schraubdeckel aus Edelstahl, mit Dosier-Rohr**  
cover stainless steel, with dosing tube  
tapa inoxidable y tubo dosificador  
couvercle inoxydable et tube doseur

	Ø cm	↑ cm	ltr.
40506	7,5	17,0	0,32



320 ml

**Zuckerdosierer**

sugar dispenser  
azucarero  
sucrier



**Schraubdeckel mit Klappe aus Edelstahl, mit Dosierklappe**  
cover stainless steel, with dosing flap  
tapa acero inoxidable, con cierre dosificador  
couvercle inox, avec couvercle doseure

	Ø cm	↑ cm	ltr.
40487	7,5	13,5	0,32





**Zuckerdosierer „OLD FASHIONED“**

sugar dispenser  
azucarero  
sucrier



Schraubdeckel mit Klappe aus Edelstahl, mit Dosierklappe  
cover stainless steel, with dosing flap  
tapa acero inoxidable, con cierre dosificador  
couvercle inox, avec couvercle doseur

	Ø cm	↑ cm	ltr.
40510	7,5	14	0,35



**Zuckerdosierer**

sugar dispenser  
azucarero  
sucrier



mit Schraubverschluss, Dosier-Rohr Ø 15 mm  
cover and dosingtube Ø 15 mm  
con tapa y tubo dosificador Ø 15 mm  
couvercle avec tube doseur Ø 15 mm

	Ø cm	↑ cm	ltr.
40508	6,5	14,5	0,20



**Zuckerspender / Milchkännchen**

sugar pourer / milk jug  
dispensador de azúcar  
sucrier doseur



matt poliert  
satin polished finish  
pulido efecto satinado  
intérieur et extérieur poli mat

	Ø cm	↑ cm	ltr.
10316	5	15	0,17



**Milch-/Universalkanne „ANTIHAFT“**

non stick jug  
jarra antiadherente  
pichet antiadhésif



PTFE-antihaftbeschichtet, perfekt für die Herstellung von Milchschaum  
PTFE coated, for baristas frothing hot milk  
revestimiento PTFE, ideal para espume de leche  
revêtement PTFE, idéal pour faire mousser le lait

	Ø cm	↑ cm	ltr.
10334	8,0	10,0	0,35
10335	9,0	11,5	0,60
10336	10,5	13,0	0,80



**Milch- / Universalkanne**

milk / water jug  
jarra leche / agua  
pichet à eau / lait



**außen hochglanzpoliert, innen matt poliert**  
outside mirror polished finish, inside satin polished finish  
exterior brillante, interior satinado  
extérieur brillant, intérieur mat satiné

	Ø cm	↑ cm	ltr.
10328	8,0	10,0	0,35
10329	9,0	11,5	0,6
10330	10,5	13,0	0,8
10331	12,0	16,5	1,3
10332	13,5	18,0	2,0



**Kaffeekanne**

coffee pot  
cafetera  
pichet à café



**hochglanzpoliert, mit Klappdeckel**  
mirror polished finish, with hinged cover  
acabado brillante, tapa con bisagra  
poli brillant, couvercle à charnière

	Ø cm	↑ cm	ltr.
10323	8,0	11,5	0,35
10322	9,0	14,0	0,6
10325	10,5	15,5	0,9
10326	12,0	18,5	1,5
10327	13,5	20,0	2,0



**Teekanne „ASIA“**

teapot  
tetera  
théière



**aus Gusseisen, innen emailliert, hält den Tee lange warm, kein nachbittern, ideal für zwei Tassen**

made of cast iron, keeps the tea warm for a long time, no bitterness, ideal for two cups

hecho de hierro fundido, mantiene el té caliente durante mucho tiempo, sin amargar, ideal para dos tazas

en fonte, maintient le thé chaud pendant longtemps, pas d'amertume, idéal pour deux tasses

ohne Teesieb / without tea strainer

mit abnehmbarem Deckel  
with removable lid

	cm	↑ cm	ltr.	Farbe / Colour
10990	12,5 x 11	12,5	0,3	■

	cm	↑ cm	ltr.	Farbe / Colour
10991	19,5 x 18	15	0,8	■
10992	19,5 x 18	15	0,8	■

inkl. Teesieb / incl. tea strainer



10318

### Milchkännchen / Sahnegießer

milk / cream jug  
jarra de leche/ crema  
pichet à eau ou lait



	Ø cm	↑ cm	ltr.
10318	4	4	0,05
10319	5	5	0,09
10320	6	6	0,15



### Milchkännchen, 4er Set

milk/cream jugs, 4 pcs.  
pack de 4 jarritas para leche o crema  
pack de 4 crémiers



hochglanzpoliert, für Kaffeesahne, mit Griff, Inhalt à 25 ml

mirror polished finish, for coffee-cream, with handle, capacity à 25 ml

pulido brillante, para crema de café, con asa, capacidad 25 ml

brillant, avec anse, 25 ml

	Ø cm	↑ cm	pcs.	ltr.
10321	3,5	3,5	4	0,025

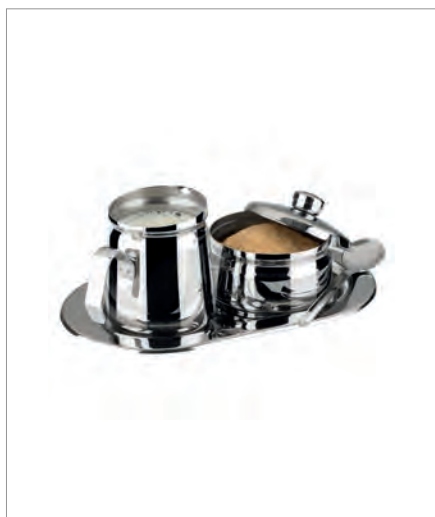

### Milch- und Zucker-Set

milk and sugar set  
set de leche y azúcar  
set sucrier et crémier



Set bestehend aus: Tablett 21 x 14 cm, H: 1,5 cm; Zuckerdose Ø 8cm, H: 7 cm; Milchkännchen Ø 6 cm, H: 8 cm, 0,2 Liter, Löffel

set consisting of: tray 21 x 14 cm, h: 1,5 cm; sugar bowl Ø 8cm, h: 7 cm; milk jug Ø 6 cm, h: 8 cm, 0,2 ltr., spoon

set compuesto por: bandeja 21 x 14 cm, a: 1,5 cm; azucarero Ø 8cm, a: 7 cm; jarra de leche Ø 6 cm, a: 8 cm, 0,2 L., cuchara

ensemble composé de: plateau 21 x 14 cm, h: 1,5 cm; sucrier Ø 8cm, h: 7 cm; crémier Ø 6 cm, h: 8 cm, 0,2 l, cuillère

	cm	↑ cm
00638	21 x 14	7



### Zuckertüten-Box

sugar pocket holder  
azucarero para bolsitas  
porte-sachetsw de sucre



matt poliert, für ca. 15 Zuckertüten

satin polished finish, for ca. 15 sugar packets

acabado pulido efecto satinado, capacidad 15 sobrecillos

poli mat, pour 15 sachets

	cm	↑ cm
11579	9 x 7,5	5



**Zuckerkugel**

sugar pot  
azucarero  
sucrier



hochglanzpoliert, mit Rolldecke  
mirror polished finish, rolltop cover  
pulido acabado brillante, tapa abatible  
brillant, couvercle abattant

	∅ cm	↑ cm
00033	13,5	15



**Teebrühsieb**

snap mesh tea ball  
infusor de té, pinza con malla  
boule à thé avec pince



matt poliert, mit feinem Sieb, aufklappbar  
satin polished finish, with fine mesh, hinged  
acabado pulido efecto satinado, con malla fina, con bisagra  
inox mat, maille fine, avec charnière

	∅ cm	→ cm
74750	4,5	15,5



**Zitronenschnitzelpresse**

lemon slice squeezer  
pinza exprimelimon  
pince presse citron



hochglanzpoliert, zum Auspressen von Zitronenscheiben  
mirror polished finish, to press lemon slices  
pulido brillante, para rodajas de limón  
brillant, pour citrons en rondelle

	cm
71430	8 x 7



**Schale, 2-geteilt**

bowl, 2-section  
cuenco, 2 secciones  
bol 2 compartiments



	cm	↑ cm
83538	17,5 x 7,5	4,5



**Flambierbrenner**

chefs blow torch  
soplete de cocina para flambear  
chalumeau de cuisine



mit handelsüblichem Feuerzeuggas auffüllbar, Flamme einstellbar  
bis ca. 1300° C, Brenndauer von min. 60 Minuten

to be filled with commercial lighter gas, flame adjustable up to  
approx. 1300° C, burning time of at least 60 minutes

rellenable con gas de mechero comercial, llama ajustable  
hasta 1300 ° C, tiempo de combustión de al menos 60 minutos

rempli avec gaz pour briquet commercial, flamme réglable  
jusqu'à 1300 ° C, temps de combustion d'au moins 60 minutes

	∅ cm	↑ cm
77315	4,5	16,5





**Tablett „VINTAGE“**

tray  
bandeja  
plateau



**Antik-Edelstahl-Look**  
stainless steel antique look  
acero estilo antiguo  
acier style antique

	cm	↑ cm
30130	26,0 x 13,5	1,5
30131	34,0 x 18,0	1,5
30132	38,0 x 26,5	1,5
30133	25,5 x 16,0	3,0

**passende Schälchen / fitting bowls / cuencos adecuados / bols appropriés**



	Ø cm	↑ cm	ltr.
40655	7,5	5,5	0,17
40656	7,5	10	0,35



S. 273  
page 273



30130



30132

**Servierbeispiel**  
presentation example



40680

40681

**Servierkelle „BOB“**

serving trowel  
paleta para servir  
truelle de service



**Edelstahl Servierkelle mit schwarzem Holzgriff**  
stainless steel serving trowel with black wooden handl  
paleta para servir de acero inoxidable con mango de madera negra  
truelle de service en acier inox avec manche en bois noir

	cm	↑ cm	Griff / handle cm	Farbe / Colour
40680	23,5 x 15,5	12,5	13,5	stainless steel
40681	23,5 x 15,5	12,5	13,5	■



**Tablett**

tray  
bandeja  
plateau



Tablett aus Edelstahl, hochglanzpoliert, stabiler Rand eingerollt  
stainless steel tray, mirror polished finish, stable edge rolled in  
bandeja de acero inoxidable, pulido efecto espejo, borde estable enrollado  
plateau en acier inoxydable, effet brillant, bord stable enrollé

	cm	↑ cm
30148	Ø 27	1,5
30149	30 x 15,5	1,5



**Serviertablett „KAFFEEHAUS“**

tray  
bandeja  
plateau



Innenfläche ziseliert, Rand eingerollt / rolled edge / borde redondeado, superficie decor  
relieve / bord rond, surface entièrement ciselée

	cm	VE
30114	30 x 22	48



**Serviertablett „KAFFEEHAUS“**

tray  
bandeja  
plateau



	cm	↑ cm	Farbe / Colour
84251	26,0 x 20,0	1,5	■
84253	28,5 x 21,5	1,5	■



**Serviertablett „KAFFEEHAUS“**

tray  
bandeja  
plateau



matt poliert, Rand eingerollt  
satin polished finish, rolled edge  
acabado pulido efecto satinado, borde redondeado  
effet satin, bord rond

	cm	↑ cm
30118	21,5 x 13	1,5



**Serviertablett „KAFFEEHAUS“**

tray  
bandeja  
plateau



matt poliert, Rand eingerollt  
satin polished finish, rolled edge  
acabado pulido satinado, borde redondeado  
effet satin mat, bord rond

	cm	↑ cm
30119	23 x 23	1,5

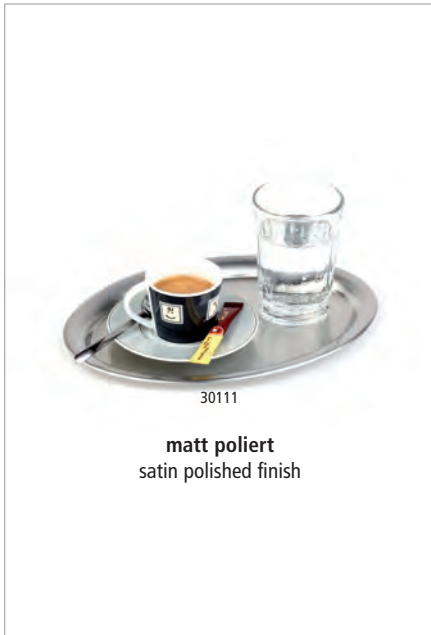

**Serviertablett „KAFFEEHAUS“**

tray  
bandeja  
plateau



**matt poliert, oval, Rand eingerollt**  
satin polished finish, oval, rolled edge  
pulido acabado efecto satinado, oval, borde redondeado  
effet satin, ovale, bord rond

	cm	↑ cm	
30111	20,0 x 14,5	0,5	für Zucker und Sahne / for sugar and cream para azúcar y crema / pour le sucre et la crème
30112	26,5 x 19,5	0,5	für eine Tasse / for one cup para una taza / pour une tasse
30113	29,0 x 22,0	0,5	für zwei Tassen / for two cups para dos tazas / pour deux tasses
30123	23,0 x 17,5	0,5	Eisdielen-Größe / icecream pralor size tamaño especial para heladerías / taille spéciale pour glaciers



**Serviertablett „KAFFEEHAUS“**

tray  
bandeja  
plateau



**hochglanzpoliert, oval, Rand eingerollt**  
mirror polished finish, oval, rolled edge  
pulido efecto espejo, ovalado, borde redondeado  
effet brillant, ovale, bord rond

	cm	↑ cm	
30115	20,0 x 14,5	0,5	für Zucker und Sahne / for sugar and cream para azúcar y crema / pour le sucre et la crème
30116	26,5 x 19,5	0,5	für eine Tasse / for one cup para una taza / pour une tasse
30117	29,0 x 22,0	0,5	für zwei Tassen / for two cups para dos tazas / pour deux tasses



**Serviertablett „KAFFEEHAUS“**

tray  
bandeja  
plateau



	cm	↑ cm	
30126	25,5 x 19,5	2	mattiert / satin polished finish acabado efecto satinado / fini mat effet satin



**Rezeptionsglocke**

ring bell  
timbre  
sonnette



	Ø cm	↑ cm	Farbe / Colour
71400	8,5	6,0	■
71433	10,0	6,5	■



**Serviertablett „HAPPY HOUR“**

tray  
bandeja  
plateau



rutschfeste Oberfläche  
non-slip surface  
superficie anti-deslizante  
surface antidérapante

	Ø cm	↑ cm	Farbe / Colour
00510	32	1,5	■
00511	38	1,5	■
00515	43	1,5	■



**Tablett „GASTRO“**

tray  
bandeja  
plateau



rutschfeste Oberfläche  
non-slip surface  
superficie anti-deslizante  
surface antidérapante

	Ø cm	↑ cm	Farbe / Colour
00547	27,5	2	■
00548	35,5	2	■
00549	40,5	2	■



**Tablett „BISTRO“**

tray  
bandeja  
plateau



rutschfest, mit 2 Griffmulden und Stapelrand  
non-slip, two open handles, stackable edge  
anti-deslizante, 2 asas  
antidérapant, 2 anses

	Ø cm	↑ cm	Farbe / Colour
84045	35,5	4,5	■



**Bierglaträger „NON-SLIP“**

beer rack  
bandeja para cerveza  
porte verre à bière



rutschfeste Oberfläche  
non-slip surface  
superficie anti-deslizante  
surface antidérapante

	Ø cm	↑ cm	Farbe / Colour
00500	36	3,5	■
00501	36	3,5	■

	cm	↑ cm	Farbe / Colour
00506	28 x 20	1,5	■
00507	28 x 20	1,5	■





**Servierbrett, 2-tlg.**  
 serving board, 2 pcs.  
 tabla de servir, set de 2  
 planche de service, set de 2

SCHIEFER  
SLATE

HOLZ  
WOOD



**2-teilig:**  
 1 Holzbrett aus Akazienholz + 1 Naturschieferplatte  
 1 wood board made of acacia wood + 1 natural slate tray  
 1 tabla de madera de acacia + 1 pizarra natural  
 1 planche en bois d'acacia + 1 ardoise naturelle

	cm	↑ cm
00814	28 x 17,5	2,0



**Servierbrett**  
 serving board  
 tabla de servir  
 planche de service



**Servierbrett aus geöltem Akazienholz**  
 serving board made of oiled acacia wood  
 tabla de servir de madera de acacia aceitada  
 planche en bois avec plateau en bois d'acacia huilé

	cm	↑ cm
00897	30 x 15	2,0
00898	30 x 18	2,0
00899	35 x 25	2,0



**Serviertablett „NON-SLIP“**  
 tray non-slip  
 bandeja antideslizante  
 plateau antiglisse



**rutschfeste Oberfläche**  
 non-slip surface  
 superficie antideslizante  
 surface antidérapante

	cm	↑ cm	GN	Farbe / Colour
00502	53 x 32,5	1,5	1/1	■
00508	46 x 36,0	2		■
00505	53 x 32,5	1,5	1/1	■
00503	53 x 37,0	1,5		■



**Tablett**  
 tray  
 bandeja  
 plateau

**rutschfest, Holzdekor-Laminat**  
 non-slip, coated wood  
 antideslizante  
 antidérapant



	cm	↑ cm
00524	43,5 x 31,5	1,5
00525	52,0 x 39,0	1,5
00526	60,5 x 42,5	1,5



**Fast Food-Tablett**

snack tray  
bandeja autoservicio y snacks  
plateau self-service et snacks



	cm	↑ cm	GN	Farbe / Colour
00530	35 x 27,0	2		
00535	41 x 30,5	2		
00540	45 x 35,5	2		
00552	53 x 32,5	2	1/1	
	cm	↑ cm	GN	Farbe / Colour
00531	35 x 27,0	2		
00536	41 x 30,5	2		
00541	45 x 35,5	2		
00553	53 x 32,5	2	1/1	
	cm	↑ cm	GN	Farbe / Colour
00532	35 x 27,0	2		
00537	41 x 30,5	2		
00542	45 x 35,5	2		
00554	53 x 32,5	2	1/1	
	cm	↑ cm	GN	Farbe / Colour
00533	35 x 27,0	2		
00538	41 x 30,5	2		
00543	45 x 35,5	2		
00555	53 x 32,5	2	1/1	



**Tablett**

tray  
bandeja  
plateau



rutschfest, Mahagonifurnier  
non-slip, woodform, mahogany  
antideslizante  
antidérapant

	Ø cm	↑ cm
00528	31,0	3,5
00529	35,5	3,5



rutschfest / non-slip



00522

**Tablett**

tray  
bandeja  
plateau



rutschfest, Holzdekor-Laminat  
non-slip, coated wood  
antideslizante  
antidérapant

	cm	↑ cm
00521	26 x 20	1
00522	29 x 21	1



**Rechnungstablent**

bill presenter  
porta cuenta  
porte-addition



**mit Klemme für Rechnung**  
with clip for bill  
con clip para la nota  
avec clip pour la note

	cm	↑ cm
30108	20 x 12	1,5



**Rechnungstablent**

bill presenter  
porta cuenta  
porte-addition



**mit Klemme für Rechnung**  
with clip for bill  
con clip para la nota  
avec clip pour la note

	cm	↑ cm
30110	17 x 11	1



**Tischkrümelentferner**

crumber  
recogemigas  
ramasse-miettes



**matt poliert**  
satin polished finish  
acabado mate, fácil de usar, mango hueco  
mat satiné, manche creux, simple à utiliser

	Ø cm	↑ cm	
00058	6,5 x 2,5	22	Hohlgriff / hollow handles
00581	19,5 x 4,5	1	geschliffene Edelstahlkante flat grinded stainless steel edge



**Tablett**

tray  
bandeja  
plateau



**Tablett aus Edelstahl, hochglanzpoliert, stabiler Rand eingerollt**  
stainless steel tray, mirror polished finish, stable edge rolled in  
bandeja de acero inoxidable, pulido efecto espejo, borde estable enrollado  
plateau en acier inoxydable, effet brillant, bord stable enroulé

	cm	↑ cm
30148	Ø 27	1,5
30149	30 x 15,5	1,5



Windaschenbecher „DIAMOND“

ashtray  
cenicero  
cendrier

Metall verchromt, Glas gefrostet, mit Bajonettverschluss  
metal chrome plated, glass frosted, bayonet lock  
metal cromado, opaco mate, cierre de bayoneta  
métal chromé, mat, verrouillage par baïonnette



	Ø cm	↑ cm	Farbe / Colour	
00565	12	8,0		Glas gefrostet / glass frosted
00566	12	8,0		Glas glänzend / glass shiny
00567	12	8,0		Glas glänzend / glass shiny



Windaschenbecher

ashtray  
cenicero  
cendrier

Metall verchromt, Glas gefrostet, mit Bajonettverschluss  
metal chrome plated, glass frosted, bayonet lock  
metal cromado, opaco mate, cierre de bayoneta  
métal chromé, mat, verrouillage par baïonnette



	Ø cm	↑ cm	Farbe / Colour	
00560	9,5	8		Glas gefrostet / glass frosted
00561	9,5	8		Glas glänzend / glass shiny
00562	9,5	8		Glas glänzend / glass shiny
00563	9,5	8		Glas glänzend / glass shiny
00564	9,5	8		Glas glänzend / glass shiny







**Drehaschenbecher „PUSH“**

ashtray  
cenicero  
cendrier



Deckel mit Drehmechanismus, mit Bajonettverschluss  
with rotary button, bayonet lock  
con botón giratorio, cierre de bayoneta  
tourne par pression sur le bouton, verrouillage par baïonnette



Drehmechanismus  
rotary button

	Ø cm	↑ cm
00568	9,5	11



**Windaschenbecher**

ashtray  
cenicero  
cendrier



Metall verchromt, Glas gefrostet, mit Bajonettverschluss  
metal chrome plated, glass frosted, bayonet lock  
metal cromado, opaco mate, cierre de bayoneta  
métal chromé, mat, verrouillage par baïonnette

	Ø cm	↑ cm	Farbe / Colour
00582	9,5	8	Black
00583	9,5	8	Yellow
00584	9,5	8	Teal
00585	9,5	8	White



**Drehaschenbecher „KLASSIKER“**

ashtray  
cenicero  
cendrier giratoire



Deckel mit Drehmechanismus  
with rotary button  
con botón giratorio  
tourne par pression sur le bouton



Drehmechanismus  
rotary button

	Ø cm	↑ cm	Farbe / Colour
00054	13,0	10,5	Black
00056	10,5	11	Black



**Aschenbecher**

ashtray  
cenicero  
cendrier



Deckel hochglanzpoliert, Behälter matt poliert, mit Windschutzdeckel  
lid mirror polished finish, container satin polished finish, with windcover  
con tapa antiviento pulida brillante y contenedor pulido efecto satinado  
couverture anti-vent brillant, corps poli mat satiné

	Ø cm	↑ cm
00052	12	5,5



Windaschenbecher

ashtray  
cenicero  
cendrier



	Ø cm	↑ cm	Farbe / Colour
83488	11,5	5	White
83489	11,5	5	Black



Windaschenbecher

ashtray  
cenicero  
cendrier



	Ø cm	↑ cm	Farbe / Colour
83610	10	4,0	White
83612	12	4,5	White
83611	10	4,0	Black
83613	12	4,5	Black



Aschenbecher

ashtray  
cenicero  
cendrier



	Ø cm	↑ cm	Farbe / Colour
83614	9,5	4,5	White
83616	9,5	4,5	Black



Aschenbecher

ashtray  
cenicero  
cendrier



**matt poliert, mit Windschutzdeckel**  
satin polished finish, with windcover  
acabado pulido satinado apilable, tapa para el viento  
poli mat, empilable, couvercle anti-vent

	Ø cm	↑ cm
00090	10	4,5
00091	12	4,5



Aschenbecher

ashtray  
cenicero  
cendrier



**matt poliert, hochwertige schwere Ausführung**  
satin polished finish, high quality, heavy gauge  
pulido satinado, alta calidad, apilable  
poli mat, empilable, belle qualité

	Ø cm	↑ cm
00048	8	3
00050	10	3



Windaschenbecher „SMOKY“

ashtray  
cenicero  
cendrier



**Metall schwarz, mit abnehmbarem Deckel**

metal black, with removable lid  
metal negro, con tapa extraíble  
métal noir, avec couvercle amovible

	Ø cm	↑ cm	Farbe / Colour
00586	8,5	11,5	■



Windaschenbecher „SMOKY“

ashtray  
cenicero  
cendrier



**Metall verzinkt, mit abnehmbarem Deckel**

metal galvanized, with removable lid  
metal galvanizado, con tapa extraíble  
métal galvanisé, avec couvercle amovible

	Ø cm	↑ cm
00578	8,5	11,5



Windaschenbecher 4er Set „MINI“

ashtray, 4 pcs.  
set de 4 cenicero  
set de 4 cendriers



	Ø cm	↑ cm	pcs.	Farbe / Colour
83620	6,5	5,5	4	■
83621	6,5	5,5	4	■



stapelbar  
stackable



Windaschenbecher „ELEMENT“

ashtray  
cenicero  
cendrier



**Beton, mit möbelschonender Unterseite**  
concrete, with non-scratching undersurface  
hormigón, con base anti rayaduras  
béton, avec revêtement antirayures

	Ø cm	↑ cm
00570	10,5	5,0



Aschenbecher, 3er Set

ashtray, 3 pcs.  
set de 3 cenicero  
set de 3 cendriers



	Ø cm	↑ cm	pcs.	Farbe / Colour
00576	8	3	3	■



**Standascher „DIABOLO“**

standing ashtray  
cenicero de pie  
cendrier sur pied



für den Innen- und Außenbereich, inkl. 1,5 kg Sand, eine Ascheschale für die Sandbefüllung und ein Metallsieb

for in-, outdoor use, included a bag of sand and a metal sieve

uso en interior o exterior, incluye una bolsa de arena y embudo de metal

usage en intérieur ou extérieur, livré avec un sac de sable et entonnoir métal

	Ø cm	↑ cm
00574	40	60



vielseitig nutzbar  
versatile



zerlegbar und stapelbar  
dismountable and stackable



**Tretbeutelhalter**

pedal bin  
soporte a pedal  
poubelle à pédale



geeignet für Müllbeutel bis 120 ltr., 110 x 70 cm

suitable for bags up to 120 ltr., 110 x 70 cm

apto para bolsas hasta 120 l, medidas sin bolsa 110 x 70 cm

apte pour sacs de 120 l, dim. sans sac 110 x 70 cm

	cm	↑ cm
00580	59 x 43	96



leichte Bedienung, Trittmehanismus  
easy handling, step on type



2 Lenkrollen mit Feststellern  
2 wheels with brakes

Gummilippe 55 cm breit, Abstand zwischen Gummilippe und Bodenblech 82 cm







# Servier- & Küchenhelfer

serving items & kitchentools

herramientas de cocina

outils de cuisine



220°C  
**POLYAMID**  
 BEST TECHNOLOGY

Das Profimaterial Polyamid besteht aus Nylon und Fiberglas. Hitzebeständig bis 220°C, extra hochwertige Profi-Qualität, gut geeignet für antihafbeschichtete Pfannen, ergonomischer Griff.

Polyamide is made of nylon and fiberglass. Heat-resistant up to 220°C, extra high quality, perfect for non-stick-coated pots and pans, ergonomic handle.

Poliamide de nylon y fibra de vidrio. Brevemente al calor hasta 220°, calta calidad profesional, ideal para sartenes antiadherentes, mango ergonómico.

Polyamide de nylon et fibre de verre, haute résistance brièvement à la chaleur jusque 220°C, qualité professionnelle, idéal pour les poêles antiadhérentes, manche ergonomique.



**Bratenwender**

turner  
 espátula  
 spatule



	cm	Griff / handle cm
00603	11 x 9,5	23



**Pfannenwender**

turner  
 espátula  
 spatule



	cm	Griff / handle cm
00600	11,5 x 9,5	23



**Pfannenwender**

turner  
 espátula  
 spatule



	cm	Griff / handle cm
00604	15 x 7,5	15



**Pfannenwender**

turner  
 espátula  
 spatule



	cm	Griff / handle cm
88642	13,5 x 9	18



**Pfannenwender**

turner  
 espátula  
 spatule



	cm	Griff / handle cm
88640	13 x 6,5	15



**Servierlöffel**  
 serving spoon  
 cuchara de servicio  
 cuillère de service



	cm	Griff / handle cm	
88608	12 x 7	23	
00607	12 x 7	23	perforiert



**Schaumlöffel**  
 skimmer  
 espumadera  
 écumoire



	Ø cm	Griff / handle cm
00602	11,5	23



**Schöpflöffel**  
 ladle  
 cucharón  
 louche



	Ø cm	Griff / handle cm	ltr.
00606	9	23	0,1



**Toastzange**  
 sandwich tong  
 pinza para sandwich  
 pince à toasts



	cm	Griff / handle cm
00601	11 x 8	18



**Spaghettizange**  
 spoon  
 pinza espaguetis  
 pince universelle ou à spaghettis



	cm	Griff / handle cm
88637	9 x 9	15



**Salatzange**  
 salad tong  
 pinza ensalada  
 pince à salade



	cm	Griff / handle cm
00605	10 x 6	23



# STOP-TOOLS

Die STOP-Funktion verhindert, dass Gabel oder Löffel in das Gefäß rutschen.

The smart STOP-function prevent forks and spoon not to slip into the vessel.

La función STOP evita que los cubiertos se caigan dentro del recipiente. Antideslizante.

La fonction STOP empêche les couverts de glisser dans le récipient.



**Servierlöffel**  
serving spoon  
cuchara de servicio  
cuillère de service



**Materialdicke 2,5 mm, ergonomischer, rutschfester Griff**  
ergonomic antislip handle  
mango ergonómico antideslizante  
manche ergonomique antidérapante

	cm	Griff / handle cm
00834	10 x 7,5	17



**Servierlöffel geschlitzt**  
slotted spoon  
cuchara de servicio  
cuillère de service



**Materialdicke 2,5 mm, ergonomischer, rutschfester Griff**  
ergonomic antislip handle  
cuchara de servicio ranurada  
cuillère de service rainurée

	cm	Griff / handle cm
00833	10 x 7,5	17



**Schöpflöffel**  
ladle  
cucharón  
louche



**Materialdicke 2,5 mm, ergonomischer, rutschfester Griff**  
ergonomic antislip handle  
mango ergonómico antideslizante  
manche ergonomique antidérapante

	Ø cm	Griff / handle cm
00832	9	17



**Fleischgabel**  
meat fork  
tenedor de carne  
fourchette à viande



**Materialdicke 2,5 mm, ergonomischer, rutschfester Griff**  
ergonomic antislip handle  
mango ergonómico antideslizante  
manche ergonomique antidérapante

	cm	Griff / handle cm
00831	10,5 x 4	17



**Servierlöffel geschlitzt**  
 serving spoon  
 cuchara de servicio ranurada  
 cuillère de service rainurée



**ergonomischer, rutschfester Griff**  
 ergonomic antislip handle  
 mango ergonómico antideslizante  
 manche ergonomique antidérapante

	cm	Griff / handle cm
00664	11 x 7	25



**Servierlöffel**  
 serving spoon  
 cuchara de servicio  
 cuillère de service



**ergonomischer, rutschfester Griff**  
 ergonomic antislip handle  
 mango ergonómico antideslizante  
 manche ergonomique antidérapante

	cm	Griff / handle cm
00662	11 x 7	25



**Schöpföffel**  
 ladle  
 cucharón  
 louche



**ergonomischer, rutschfester Griff**  
 ergonomic antislip handle  
 mango ergonómico antideslizante  
 manche ergonomique antidérapante

	cm	Griff / handle cm	ltr.
00670	9 x 8	25	0,10



**Wender**  
 slotted turner  
 espátula para plancha  
 spatule pour le grill



**ergonomischer, rutschfester Griff**  
 ergonomic antislip handle  
 mango ergonómico antideslizante  
 manche ergonomique antidérapante

	cm	Griff / handle cm
00668	10 x 8	25



**Fleischgabel**  
 meat fork  
 tenedor de carne  
 fourchette à viande



**ergonomischer, rutschfester Griff**  
 ergonomic antislip handle  
 mango ergonómico antideslizante  
 manche ergonomique antidérapante

	cm	Griff / handle cm
00666	10 x 3,5	25



Schöpflöffel „PROFI“

ladle  
cacillo  
louche



	Ø cm	Griff / handle cm	ltr.
00711	6	28	0,050
00712	7	30	0,080
00713	8	32	0,125
00714	9	33	0,150
00715	10	35	0,250
00716	11	36	0,300



Schaumlöffel „PROFI“

skimmer  
espumadera  
écumoire



	Ø cm	Griff / handle cm
00721	10	34
00722	12	37
00723	14	40



Wender „PROFI“

turner  
espátula  
spatule



	cm	Griff / handle cm
00730	10 x 11,5	38



Servierlöffel „PROFI“

serving spoon  
cuchara de servicio  
cuillère de service



	cm	Griff / handle cm	
00671	11 x 7	29	geschlitzt / slotted
00672	11 x 7	29	



Spaghettilöffel „PROFI“

spaghetti spoon  
cuchara de espaguetis  
cuillère à spaghettis



	cm	Griff / handle cm
00673	10 x 7	29



**Servierlöffel „CLASSIC“**

serving spoon  
cuchara de servicio  
cuillère de service



hochglanzpoliert, perforiert, Löcher Ø 4 mm, ergonomisch profilierter Hohl-Griff  
mirror polished finish, perforated, holes Ø 4 mm, ergonomic designed handle  
pulido brillante agujeros de Ø 4 mm, asa ergonómica  
brillant, trous Ø 4 mm, manche ergonomique

	cm	Griff / handle cm
75903	9,5 x 7	23,5



**Salatlöffel „CLASSIC“**

salad spoon  
cuchara para ensalada  
cuillère à salade



hochglanzpoliert, ergonomisch profilierter Hohl-Griff  
mirror polished finish, ergonomic designed handle  
inox brillante, asa ergonómica  
brillant, manche ergonomique

	cm	Griff / handle cm
75902	8 x 6	21,5
75904	9,5 x 7	23,5



**Suppenkelle „CLASSIC“**

soup ladle  
cucharón de sopa  
louche de service



hochglanzpoliert, ergonomisch profilierter Hohl-Griff  
mirror polished finish, ergonomic designed handle  
pulido brillante, asa ergonómica  
brillant, manche ergonomique

	Ø cm	Griff / handle cm	litr.
75907	7	23	0,06
75908	9	24	0,1



**Saucengießlöffel „CLASSIC“**

sauce / gravy ladle  
cucharón de salsa  
cuillère à sauce



hochglanzpoliert, ergonomisch profilierter Hohl-Griff, fugenlos  
mirror polished finish, ergonomic designed handle, seamless  
pulido brillante, asa ergonómica, sin soldadura  
brillant, manche ergonomique, monobloc (sans soudure)

	cm	Griff / handle cm	litr.
75906	7 x 5,5	22	0,02



**Tortenheber „CLASSIC“**

cake lifter  
pala de tartas  
pelle à gâteau



hochglanzpoliert, mit einer gezahnten Kante, ergonomisch profilierter Hohl-Griff  
mirror polished finish, one edge serrated, ergonomic designed handle  
pulido brillante, canto dentado, mango ergonómico  
brillant, bord microdenté, manche ergonomique

	cm	Griff / handle cm
75900	8 x 5	10,5
75912	5 x 1	12



# BANQUET



Die Vorlegeserie BANQUET ist die passende Ergänzung zum Servieren am Buffet. Durch die mattierte Oberfläche und das gebogene Griffende wird BANQUET praktischen und optischen Ansprüchen gerecht.

The series BANQUET is the perfect addition for serving at the buffet. Due to the matt surface and the curved handle, BANQUET meets practical and optical requirements.

La serie BANQUET es la adición perfecta para servir en el buffet. Debido a la superficie mate y al mango curvado, BANQUET cumple con requisitos prácticos y ópticos.

La série BANQUET est l'ajout parfait pour servir au buffet. Grâce à la surface mate et la poignée incurvée, BANQUET répond aux exigences pratiques et optiques.



## Salat- / Servierlöffel „BANQUET“

salad spoon / serving spoon  
cuchara para ensalada / cuchara de servicio  
cuillère à salade / cuillère de service



	cm	Griff / handle cm
00588	6 x 5	17
00590	7,5 x 6	21



## Salatgabel „BANQUET“

salad fork  
tenedor de servicio para ensalada  
fourchette de service pour la salade



	cm	Griff / handle cm
00589	6 x 5	17
00591	7,5 x 6	21



## Pfannenwender „BANQUET“

turner  
espátula  
spatule



	cm	Griff / handle cm
00587	10 x 7,5	21



**Chafing Dish Löffel „BANQUET“**

serving spoon  
cuchara para servir  
cuillère de service



	cm	Griff / handle cm	
00592	11 x 6,5	24	
00593	11 x 6,5	24	geschlitzt / slotted



**Dressinglöffel „BANQUET“**

dressing spoon  
cuchara de aliño  
cuillère à vinaigrette



	cm	Griff / handle cm
00594	6 x 4	30



**Schöpflöffel „BANQUET“**

ladle  
cucharón  
louche



	cm	Griff / handle cm
00595	8,5 x 7,5	24



**Fleischgabel „BANQUET“**

meat fork  
tenedor de carne  
fourchette à viande



	cm	Griff / handle cm
00596	8 x 2,5	13



**Serviergabel „BANQUET“**

fork  
tenedor de servicio  
fourchette de service



	cm	Griff / handle cm
00597	9 x 4	21



**Tortenheber „BANQUET“**

cake lifter  
pala de tartas  
pelle à gâteau



eine Kante gezahnt  
one edge serrated  
un borde serrado  
denté sur un côté

	cm	Griff / handle cm
00598	14 x 6	13



**Salatzange „TIDLOS“**

salad tong  
pinza ensalada  
pince à salade

hochglanzpoliert, einseitig geschlitzt  
mirror polished finish, slotted on one side  
acabado brillante, agujereada en un lado  
brillant, perforée d'un seul côté



	cm	→ cm
75842	5 x 2	22



**Pastazange „TIDLOS“**

pasta tongs  
pinza espaguetis  
pince à spaghettis

hochglanzpoliert, beidseitig geschlitzt  
mirror polished finish, slotted on both side  
acabado brillante, agujereada en 2 lados  
brillant, perforées des 2 côtés



	cm	→ cm
75843	8 x 5,5	22,5



**Spargelzange „TIDLOS“**

asparagus tongs  
pinzas para espárragos  
pince à asperges

hochglanzpoliert / mirror polished finish / acabado brillante / brillant



	cm	→ cm
75844	7 x 11	24,5



**Gebäckzange „TIDLOS“**

pastry tongs  
pinza para pasteles  
pince à gâteaux

hochglanzpoliert / mirror polished finish / acabado brillante / brillant



	cm	→ cm
75840	6,5 x 4,5	21



**Servierzange „TIDLOS“**

serving tongs  
pinza universal  
pince universelle

hochglanzpoliert / mirror polished finish / acabado brillante / brillant



	cm	→ cm
75841	7 x 4,5	21



**Universalzange**

all-purpose tong  
pinza universal  
pince universelle

Edelstahl, Antik-Edelstahl-Look / Vintage-Look

stainless steel, stainless antique look  
acero inoxidable, acero estilo antiguo  
acier inox, acier style antique



	cm	→ cm	Farbe / Colour	€
75825	7 x 5	22,5		vintage-look



**Universalzange**

all - purpose tong  
pinza universal  
pince universelle

hochglanzpoliert

mirror polished finish  
acabado brillante  
brillant



	cm	→ cm	Farbe / Colour	€
75830	7 x 5	25		mirror polished



**Universalzange**

all - purpose tong  
pinza universal  
pince universelle

hochglanzpoliert, Gold-Look

mirror polished finish, gold-look  
pulido brillante, dorado  
poli brillant, doré



	cm	→ cm	Farbe / Colour	€
75831	7 x 5	25		gold-look



**Universalzange**

all - purpose tong  
pinza universal  
pince universelle

hochglanzpoliert, Kupfer-Look

mirror polished finish, copper-look  
pulido brillante, cobre  
poli brillant, cuivre



	cm	→ cm	Farbe / Colour	€
75832	7 x 5	25		copper-look



**Salatzange**

salad tong  
pinza ensalada  
pince à salade

hochglanzpoliert, beidseitig geschlitzt / mirror polished finish, slotted on both side  
acabado brillante, agujereada en 2 lados / brillant, perforéedes 2 côtés



	cm	→ cm	Farbe / Colour	€
75801	5 x 2	24		mirror polished





**Spaghettizange**

spaghetti tong  
pinza espaguetis  
pince à spaghettis

hochglanzpoliert, fugenlos  
mirror polished finish, seamless  
acabado brillante, sin soldaduras  
brillant, monobloc



	cm	→ cm	
75810	6 x 3	19	



**Vorspeisenzange „BANQUET“**

appetizer tong  
pinza para aperitivos  
pince à apéritif

Vorderteil poliert, Stiel mattiert  
front part: high-shiny, handle: matt-finish  
parte delantera pulida, asa mate  
partie avant polie, poignée matte



	cm	→ cm	€
75822	4,5 x 3,5	20	



**Ideal für Vorspeisen**  
ideal for starters



**Universalzange**

all-purpose tong  
pinza universal  
pince universelle

Edelstahl, Antik-Edelstahl-Look / Vintage-Look  
stainless steel, stainless antique look  
acero inoxidable, acero estilo antiguo  
acier inox, acier style antique



	cm	→ cm	€
75823	5,5 x 5,0	20	



**Ideal für Geschnittenes**  
ideal for sliced products



**Universalzange**

all-purpose tong  
pinza universal  
pince universelle

Edelstahl, Antik-Edelstahl-Look / Vintage-Look  
stainless steel, stainless antique look  
acero inoxidable, acero estilo antiguo  
acier inox, acier style antique



	cm	→ cm	€
75824	7 x 5	22,5	



**Pinzettenzange**  
 fine tong / tweezer  
 pinza de emplatar  
 pince à dresser



hochglanzpoliert, geriffelte Grifffläche, schwere Qualität  
 mirror polished finish, ribbed handle, heavy gauge  
 acabado brillante, mango cómodo ranurado, alta calidad  
 brillant, manche rainuré antiglisse, qualité extra

..... → cm  
 75820 16



**Pinzettenzange**  
 fine tong / tweezer  
 pinza de emplatar  
 pince à dresser



hochglanzpoliert, geriffelte Grifffläche, schwere Qualität  
 mirror polished finish, ribbed handle, heavy gauge  
 acabado brillante, mango cómodo ranurado, alta calidad  
 brillant, manche rainuré antiglisse, qualité extra

..... → cm  
 75821 30



**Pinzettenzange**  
 fine tong / tweezer  
 pinza de emplatar  
 pince à dresser



hochglanzpoliert, geriffelte Grifffläche, schwere Qualität  
 mirror polished finish, ribbed handle, heavy gauge  
 acabado brillante, mango cómodo ranurado, alta calidad  
 brillant, manche rainuré antiglisse, qualité extra

..... → cm  
 75809 30



**Pinzettenzange**  
 fine tong / tweezer  
 pinza de emplatar  
 pince à dresser



hochglanzpoliert, geriffelte Grifffläche, abgerundete Spitzen vorne, schwere Qualität  
 mirror polished finish, ribbed handle, rounded on the tops, heavy gauge  
 acabado brillante, mango cómodo ranurado, alta calidad, puntas redondeadas  
 brillant, manche rainuré antiglisse, qualité extra, pointes arrondies

..... → cm  
 75808 14,5



**Salatzange**  
 salad serving tong  
 pinza de ensalada  
 pince à servir la salade



hochglanzpoliert, einfache Handhabung  
 mirror polished finish, convenient handling  
 pulido brillante, manejo cómodo  
 brillant, manipulation aisée

	cm	→ cm
00685	7,0 x 4,5	25



**Universalzange**  
 all - purpose tong  
 pinzas multiusos  
 pince multi-usages



hochglanzpoliert, einfache Handhabung  
 mirror polished finish, convenient handling  
 pulido brillante, manejo cómodo  
 brillant, manipulation aisée

	cm	→ cm
00688	7,0 x 4,5	25



**Brot- und Gebäckzange**  
 bread and pastry tong  
 pinza para pan y bollería  
 pince à pain ou viennoiseries



hochglanzpoliert, einfache Handhabung  
 mirror polished finish, convenient handling  
 pulido brillante, manejo cómodo  
 brillant, manipulation aisée

	cm	→ cm
00686	7,0 x 4,5	25



**Brot- und Gebäckzange**  
 bread and pastry tong  
 pinza para pan y bollería  
 pince à pain ou viennoiseries



hochglanzpoliert, einfache Handhabung  
 mirror polished finish, convenient handling  
 pulido brillante, manejo cómodo  
 brillant, manipulation aisée

	cm	→ cm
00687	7,0 x 4,5	25



**Aufschnitt- / Allzweckzange**

sausage tong  
pinza salchichas  
pince à saucisses



hochglanzpoliert, fugenlos  
mirror polished finish, seamless  
pulido brillante, sin soldadura  
brillant, monobloc

	cm	→ cm
75806	3 x 2,5	16



**Allzweckzange**

multipurpose tong  
pinza multi-usos  
pince universelle multi-usages



hochglänzend, mit Feder und Verschlusschieber, dekorative Greiferform  
high-gloss finish, with spring and retaining clip, decorative gripper form  
pulido brillante, con muelle y cierre deslizante, gancho con forma decorativa  
finition brillante, avec mécanisme de verrouillage, forme de pince décorative

	cm	→ cm
88643	4 x 3	24
88644	4 x 3	30
88645	4 x 3	40



**Universalzange**

all - purpose tong  
pinza universal  
pince universelle



hochglanzpoliert, einseitig geschlitzt  
mirror polished finish, slotted on one side  
acabado brillante, agujereada en un lado  
brillant, perforée d'un seul côté

	cm	→ cm
75800	5 x 2	24



**Gebäckzange**

pastry tong  
pinza para pasteles  
pince à gâteaux



hochglanzpoliert, fugenlos, extra schwere Qualität  
mirror polished finish, seamless, extra heavy gauge  
pulido brillante, sin soldadura, alta calidad, resistente  
brillant, monobloc, qualité extra, robuste

	cm	→ cm
75807	8,5 x 4	27,5





**Gebäck- / Tortenzange**

pastry tong  
pinza para pasteles  
pince à gâteaux

hochglanzpoliert, fugenlos  
mirror polished finish, seamless  
acabado brillante, sin soldadura  
brillant, monobloc



	cm	→ cm
75803	7 x 3,5	17,5



**Gebäckzange**

pastry tong  
pinza para pasteles  
pince à gâteaux

hochglanzpoliert, perforiert  
mirror polished finish, perforated  
pulido brillante, perforado  
brillant, perforée



	cm	→ cm
75804	6,5 x 3	19,5



**Eisportionierer**

ice cream scoop  
cuchara para helado  
cuillère à glace

hochglanzpoliert, mit Edelstahlfeder (physikalisch bedingt nicht korrosionsbeständig)  
mirror polished finish, spring steel, spring is not stainless  
pulido brillante, muelle de acero especial, no resistente al óxido  
poli brillant, ressort acier spécial, non résistant à l'oxydation



	∅ cm	→ cm	litr.
71006	6,5	23,5	1/12
71005	6,0	22,5	1/16
71004	5,5	22,0	1/20
71003	5,0	22,0	1/24
71002	5,0	21,5	1/30
71001	4,5	21,0	1/36



**Messlöffelsatz**

set measuring spoon  
juego de cucharas medidoras  
jeu de cuillère à mesure

Löffel hochglanzpoliert, Stiele matt poliert, Skalierung:  
1 Esslöffel, 1 Teelöffel, 1/2 Teelöffel, 1/4 Teelöffel

bowl mirror polished finish, handles satin polished finish, measures:  
table spoon, tea spoon, 1/2 tea spoon, 1/4 tea spoon

bol medidor brillante, mango mate medidas:

1 cuchara de sopa, 1 cuchara de té, 1/2 cuchara de té, 1/4 cuchara de té

corps brillant, manche mat, mesures:

1 cuillerée à soupe, 1 cuillerée à thé, 1/2 cuillère à thé, 1/4 de cuillère à thé



	cm
75600	14 x 4,5



**Feinkostlöffel, 6er Set**  
 delicatessen spoon, 6 pcs.  
 cuchara gourmet, set de 6  
 cuillère gourmet, set de 6



aus Kunststoff  
 plastic  
 plástico  
 plastique

	Ø cm	→ cm	pcs.	Farbe / Colour
88627	6	23	6	White



**Feinkostlöffel, 6er Set**  
 delicatessen spoon, 6 pcs.  
 cuchara gourmet, set de 6  
 cuillère gourmet, set de 6



aus Kunststoff  
 plastic  
 plástico  
 plastique

	Ø cm	→ cm	pcs.	Farbe / Colour
88628	6	23	6	Black



**Feinkost- / Olivenlöffel, 6er Set**  
 delicatessen / olives spoon, 6 pcs.  
 cuchara gourmet / para aceitunas, set de 6  
 cuillère gourmet / à olives, set de 6



gelocht  
 perforated  
 perforadas  
 perforées

	cm	→ cm	pcs.	Farbe / Colour
88598	6 x 9	27	6	Black

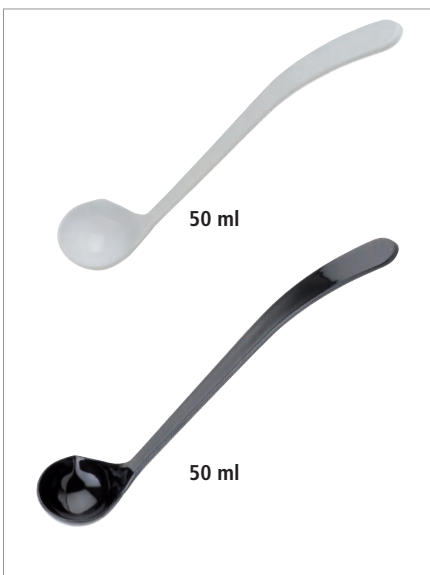

**Dressinglöffel**  
 dressing spoon  
 cuchara de aliño  
 cuillère à sauce



aus Kunststoff  
 plastic  
 plástico  
 plastique

	Ø cm	→ cm	ltr.	Farbe / Colour
88636	6	34	0,05	White
88609	6	34	0,05	Black

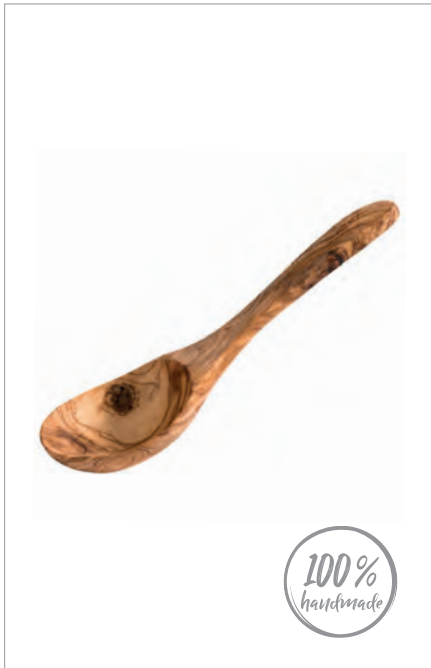

Löffel „OLIVE“

spoon  
cuchara  
cuillère

HOLZ  
WOOD



aus Olivenholz, ideal für Reis, Gemüse...  
olive wood, ideal for rice, vegetables...  
madera de olivo, ideal para arroz, verduras...  
en bois d'olivier, idéal pour le riz, les légumes...

	cm	→ cm
00840	9,5 x 8,5	17,0

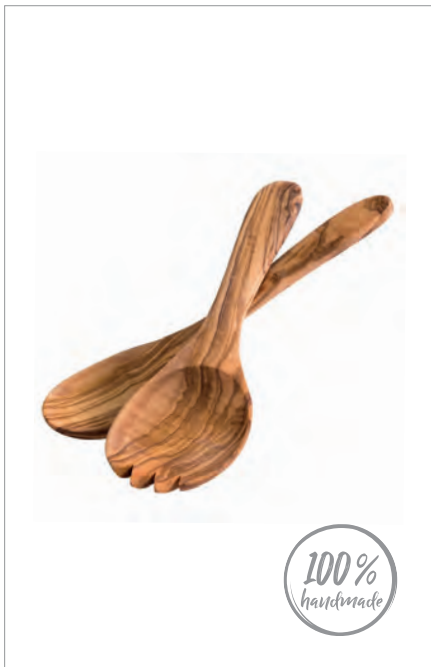

Salatbesteck „OLIVE“, 2er Set

spoon, 2 pcs.  
cuchara, set de 2  
cuillère, set de 2

HOLZ  
WOOD



aus Olivenholz  
olive wood  
madera de olivo  
en bois d'olivier

	cm	→ cm
00841	9,5 x 8,5	17,0



Salatbesteck „OLIVE“, 2er Set

spoon, 2 pcs.  
cuchara, set de 2  
cuillère, set de 2

HOLZ  
WOOD



aus Olivenholz  
olive wood  
madera de olivo  
en bois d'olivier

	cm	→ cm
00842	7,5 x 6,0	22,5





100%  
handmade

**Löffel „ACACIA“**

spoon  
cuchara  
cuillère

HOLZ  
WOOD



aus Akazienholz, ideal für Reis, Gemüse...  
acacia wood, ideal for rice, vegetables...  
madera de acacia, ideal para arroz, verduras...  
bois d'acacia, idéal pour le riz, les légumes...

..... cm → cm  
00599 9 x 6,5 23,5



NEW

100%  
handmade

**Löffel „OLIVE“, 2er Set**

spoon, 2 pcs.  
cuchara, set de 2  
cuillère, set de 2

HOLZ  
WOOD



aus Olivenholz, ideal für Gewürze  
olive wood, ideal for spices  
madera de olivo, ideal para especias  
en bois d'olivier, idéal pour les épices

..... → cm  
01018 14



NEW

100%  
handmade

**Honiglöffel „OLIVE“**

honey spoon  
cuchara de miel  
cuillère à miel

HOLZ  
WOOD



aus Olivenholz  
olive wood  
madera de olivo  
en bois d'olivier

..... → cm  
01019 15



NEW

100%  
handmade

**Schaufel „OLIVE“**

scoop  
pala  
pelle

HOLZ  
WOOD



aus Olivenholz, ideal für Gewürze, Körner etc.  
olive wood, ideal for spices, grains etc.  
madera de olivo, ideal para especias, granos etc.  
en bois d'olivier, idéal pour les épices, céréales, etc.

..... → cm  
01020 13,5







**Kugelausstecher - doppelt „ORANGE“**

melon baller - double  
vaciador doble de bola  
moule à boule double



zum Formen von Kugeln aus Obst, Gemüse oder Butter, Edelstahl mit geschärften Rändern  
to form balls out of fruits, vegetables, butter, etc., stainless steel with sharpened edge  
para hacer bolas con frutas, verduras, mantequilla, etc. acero inoxidable con borde afilado  
pour faire des boules de fruits, légumes, beurre, etc. inox, bord affûté

	∅ cm	→ cm
88810	2,2 + 2,5	16,5
88811	2,2 + 3,0	17



**Fadenschneider / Zester „ORANGE“**

decorator / zester  
cuchillo de decoración cincelador  
couteau zesteur



zum Abziehen von feinsten Schalenstreifen, ideal zum Dekorieren von Torten und Desserts  
to peel off very fine stripes of paring, these stripes are ideal to decorate desserts, cakes, etc.  
para pelar tiras muy finas, ideal para decorar postres, tartas, etc.  
pour couper en lanières fines, idéal pour la décoration de gâteaux et desserts, etc.

	∅ cm	→ cm
88823	0,2 + 0,5	14,5



**Ziseliermesser „ORANGE“**

canele / decorating knife  
cuchillo de decoración cincelador acanalado  
couteau zesteur cannelé



zum Einritzen von Linien und Mustern in hartschaliges Obst und Gemüse, Edelstahl mit geschärften Rändern  
to score lines or design in hard fruits and vegetables, stainless steel with sharpened edge  
para dibujar líneas en frutas o verduras de piel dura, acero inoxidable con borde afilado  
pour découper des lignes et motifs sur fruits et légumes à peau dure ou pour peler les zestes des citrons ou oranges, inox, bord affûté

	→ cm
88826	15



**Sparschäler „ORANGE“**

peeler  
pelador  
peleur



für Links- und Rechtshänder geeignet, mit zwei starren Klingen aus extra geschärftem + gehärtetem Edelstahl  
useable left- and right handed, with 2 inflexible blades made out off sharpened, extra hardened stainless steel

para diestros y zurdos, con 2 cuchillas rígidas inox afiladas y muy resistentes  
pour gauchers ou droitiers, 2 lames rigides affûtés en inox extra-résistant

	→ cm
88827	17



**Pendelschäler „ORANGE“**

swivel peeler  
pelador reversible  
éplucheur droitier/gaucher



für Links- und Rechtshänder, ideal für das Schälen von Tomaten, mit 2 beweglichen Klingen  
suitable for right and left handed, ideal to peel tomatoes, with 2 flexibles blades  
apto para diestros y zurdos, ideal para pelar tomates, con 2 hojas flexibles  
pour gauchers ou droitiers, idéal pour peler les tomates, 2 lames flexibles

→ cm

88850 16,5



**Cocktailmesser**

bar knife  
cuchillo para cóctel  
couteau cocktail



mit 2 Zinken zum Aufspießen von Zitrusseiben  
with 2 prongs to pick up slices of lemon  
con 2 dientes para pinchar las rodajas de limón, etc.  
avec 2 dents pour les rondelles de citron et autres décorations

→ cm

88846 21



**Pizzateigschneider „ORANGE“**

pizza cutter  
cortador de pizza  
roulette à pizza



zum einfachen Zerteilen von Pizza  
to cut pizza easily  
para cortar pizza fácilmente  
pour une coupe facile de la pizza

Ø cm → cm

88829 6 18,5



**Pendelschäler „ORANGE“**

swivel peeler  
pelador lama pivotante  
peleur lame pivotante



zum schnellen und sparsamen Schälen von Obst und Gemüse, mit beweglicher Klinge  
to peel fruits and vegetables with flexible blade  
para pelar frutas y verduras con hoja flexible  
pour couper des fruits et légumes avec lame flexible

→ cm

88834 17



**Apfelentkerner „ORANGE“**

apple corer  
descorazonador de manzana  
vide-pomme



durch leichtes Drehen kann das Kerngehäuse von Äpfeln, Birnen und anderen Früchten sorgsam herausgeholt werden, Edelstahl mit geschärften Rändern  
with a light turn cores of apples, pears and other fruits can be cut off easily, stainless steel with sharpened edge  
para descorazonar muy fácilmente manzanas, peras y otras frutas  
pour évider facilement les pommes, poires ou autres fruits

Ø cm → cm

88836 2,2 21



**Austernöffner „ORANGE“**

oyster knife  
 abre ostras  
 couteau à huîtres



zum einfachen Aufbrechen von Austern, mit Fingerschutz, Edelstahl mit geschärften Rändern  
 to open oysters easily, with guard, stainless steel with sharpened edge  
 para abrir ostras fácilmente con protección para los dedos, acero inoxidable con punta afilada  
 pour ouvrir facilement les huîtres avec protection pour les doigts, inox, pointe affûtée

.....  
 → cm  
 .....  
 88839 14,5



**Austernmesser „ORANGE“**

oyster knife  
 abre ostras  
 couteau à huîtres



Edelstahl-Klinge zum Einstechen in die Schale, mit Fingerschutz  
 to open oysters easily, with guard  
 para abrir ostras fácilmente con protección para los dedos  
 pour ouvrir facilement les huîtres avec protection pour les doigts

.....  
 → cm  
 .....  
 88840 15



**Dekoriermesser „ORANGE“**

decorating knife „canalé“  
 cuchillo acanalador  
 couteau cannelé



gezahnte Klinge aus geschärftem Edelstahl  
 serrated sharpened blade, stainless steel  
 hoja de sierra afilada, acero inoxidable  
 lame inox microdentée

.....  
 → cm  
 .....  
 88843 19



**Käsehobel „ORANGE“**

cheese slicer  
 rebanador de queso  
 couteau tranche-fromage



zum Schneiden von dünnen Käsescheiben  
 to cut thin slices of cheese  
 para cortar lonchas finas de queso  
 pour couper de fines tranches de fromage

.....  
 → cm  
 .....  
 88853 21,5



**Streichpalette „BLUE“**

spatula  
espátula  
spatule



flexible Edelstahl-Klinge, rutschfester Griff, hitzebeständig  
flexible blade stainless steel, non-slip handle, heat-resistant  
hoja flexible acero inoxidable mango polipropileno termoresistente anti-deslizante  
lame inox flexible, manche antiglisse en polypropilène thermorésistant

	cm	→	cm
88920	35 x 5		48,5
88921	30,5 x 4,5		43,5
88922	25 x 4		38,0
88923	20 x 3		33,5



**Winkelpalette „BLUE“**

spatula  
espátula  
spatule



flexible Edelstahl-Klinge  
flexible blade stainless steel  
hoja flexible acero inoxidable  
lame inox flexible

	cm	→	cm
88928	17 x 5		30



**Gebäckpalette „BLUE“**

pastry spatuala  
paleta pastelera  
spatule pâtissière



flexible Edelstahl-Klinge  
flexible blade stainless steel  
hoja flexible acero inoxidable  
lame inox flexible

	cm	→	cm
88932	17 x 7,5		29,5



**Wender „BLUE“**

turner  
espátula  
spatule



flexible Edelstahl-Klinge  
flexible blade stainless steel  
hoja flexible acero inoxidable  
lame inox flexible

	cm	→	cm
88933	15 x 6		27,5





**Winkelpalette „BLUE“**

turner  
espátula  
spatule

flexible Edelstahl-Klinge  
flexible blade stainless steel  
hoja flexible acero inoxidable  
lame inox flexible



	cm	→ cm
88935	34 x 5	47,5
88937	24 x 4	36
88938	18,5 x 3	32



**Wender „BLUE“**

turner  
espátula  
spatule

flexible Edelstahl-Klinge  
flexible blade stainless steel  
hoja flexible acero inoxidable  
lame inox flexible



	cm	→ cm
88939	24 x 7,5	37,5



**Wender „BLUE“**

turner  
espátula  
spatule

perforiert, flexible Edelstahl-Klinge  
perforated, flexible blade stainless steel  
hoja flexible inox agujereada  
lame ajourée inox flexible



	cm	→ cm
88940	24,5 x 7,5	37,5



**Wender „BLUE“**

turner  
espátula para plancha  
spatule

flexible Edelstahl-Klinge  
flexible blade stainless steel  
hoja flexible acero inoxidable  
lame inox flexible



	cm	→ cm
88941	20 x 7,5	33
88942	15 x 9	28



**Spachtel / Schaber „BLUE“**

scraper  
 espátula plancha  
 spatule coudée spéciale grill

starre Edelstahl-Klinge  
 rigid blade stainless steel  
 hoja rígida acero inoxidable  
 lame inox rigide



	cm	→ cm
88929	11 x 10	25



**Spachtel / Fettabstecher „BLUE“**

scraper  
 espátula plancha  
 spatule coudée spéciale grill

starre Edelstahl-Klinge  
 rigid blade stainless steel  
 hoja rígida de acero inoxidable  
 lame rigide inox



	cm	→ cm
88946	17 x 10	30
88947	15 x 7,5	28

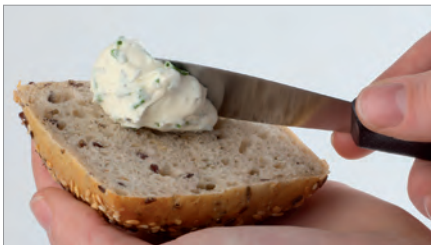

**Aufstrichmesser „BLUE“**

sandwich knife  
 cuchillo para untar  
 couteau à tartiner

flexible Edelstahl-Klinge  
 flexible blade stainless steel  
 hoja flexible acero inoxidable  
 lame inox flexible



	cm	→ cm
88948	8,5 x 3	18,5



**Teigschaber / Abstecher „BLUE“**

dough scraper  
 corta pasta  
 coupe-pâte

starre Edelstahl-Klinge  
 rigid blade stainless steel  
 hoja rígida de acero inoxidable  
 lame rigide inox



	cm
88930	15,5 x 8



**Pizzaschneider „BLUE“**

pizza cutter  
cortador de pizza  
coupe-pizza

ergonomischer Griff  
ergonomic handle  
mango ergonómico  
manche ergonomique



	Ø cm	→ cm
88949	10	20

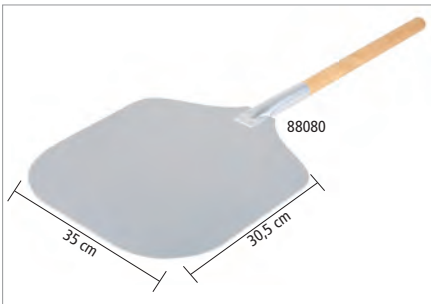

**Pizzaschaufel**

pizza peel  
pala de pizza  
pelle à pizza



	cm	→ cm
88080	35 x 30,5	90
88081	35 x 30,5	130



**Eierschneider**

egg cutter  
corta huevos  
coupe-oeufs

zum Längs- und Querteilen von hart gekochten Eiern  
to cut hard-boiled eggs  
corta a rodajas un huevo duro  
en rondelles



	cm	↑ cm
88099	14,5 x 8	2,5



**Hummerbrecher**

lobster cracker  
pinza bogavante  
pince à homard



	cm
74201	14 x 5,5



**Flambierbrenner**

chefs blow torch  
soplete de cocina para flambear  
chalumeau de cuisine

mit handelsüblichem Feuerzeuggas auffüllbar, Flamme einstellbar  
bis ca. 1300° C, Brenndauer von min. 60 Minuten

to be filled with commercial lighter gas, flame adjustable up to  
approx. 1300° C, burning time of at least 60 minutes

rellenable con gas de mechero comercial, llama ajustable  
hasta 1300° C, tiempo de combustión de al menos 60 minutos

rempli avec gaz pour briquet commercial, flamme réglable  
jusqu'à 1300° C, temps de combustion d'au moins 60 minutes



	Ø cm	↑ cm
77315	4,5	16,5



**Schneebesens**

whisk  
batidor  
fouet



	Drähte / wires	→ cm
00744	8	28
00745	8	33
00746	8	38
00747	8	43
00740	8	48

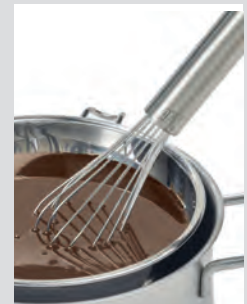

**Passiersieb**

strainer  
colador  
passoire



feines Siebgewebe mit ca. 6 Löchern pro 1 cm<sup>2</sup>  
fine mesh with 6 holes per 1 cm<sup>2</sup>  
malla fina con 6 agujeros por 1 cm<sup>2</sup>  
toile fine avec 6 trous pour 1 cm<sup>2</sup>

	Ø cm	→ cm
74700	14	30
74701	16	32
74702	18	34
74703	20	36
74705	24	41
74706	26	43



**Passiersieb**

strainer  
colador  
passoire



mit Doppelnetz, Netz außen: ca. 2 Löcher pro 1 cm, Netz innen: ca. 5 Löcher pro 1 cm  
with double mesh, outer mesh about 2 holes per cm, inner mesh about 5 holes per cm  
con malla doble, malla exterior aprox. 2 agujeros /cm, interior aprox. 5 agujeros /cm  
avec double étamine, extérieure env. 2 trous/cm, intérieure environ 5 trous/cm

	Ø cm	→ cm
74721	19,5	41,0
74722	24,5	56,5





**Passiersieb**

strainer  
colador  
passoire



feines Siebgewebe mit ca. 6 Löchern pro 1 cm<sup>2</sup>  
fine mesh with 6 holes per 1 cm<sup>2</sup>  
malla fina con 6 agujeros por 1 cm<sup>2</sup>  
toile fine avec 6 trous pour 1 cm<sup>2</sup>

	Ø cm	→ cm
88617	26,0	56,5
88618	30,0	60,0
88639	33,5	62,5

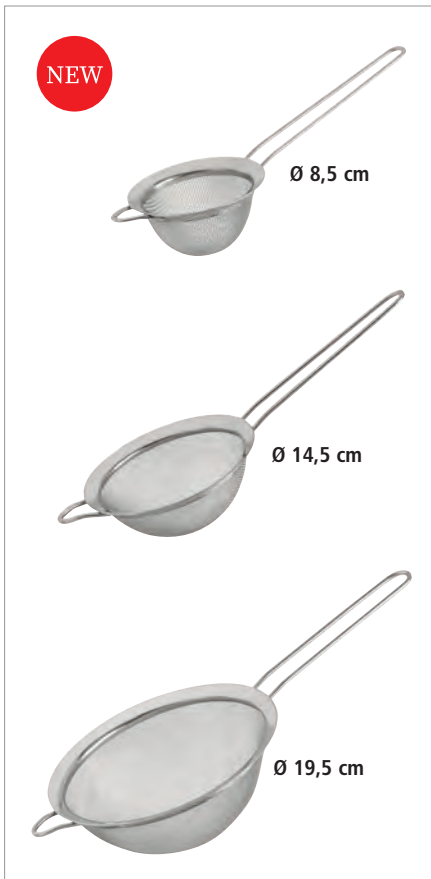

**Passiersieb, 3er Set**

strainer, 3 pcs.  
colador, set de 3  
passoire, set de 3



3-teiliges Set bestehend aus 3 Sieben:

Ø 8,5 cm, L: 22,5 cm / Ø 14,5 cm, L: 32 cm / Ø 19,5 cm, L: 38,5 cm

set of 3 consisting of 3 sieves:

Ø 8,5 cm, L: 22,5 cm / Ø 14,5 cm, L: 32 cm / Ø 19,5 cm, L: 38,5 cm

set de 3 que consta de 3 tamices:

Ø 8,5 cm, L: 22,5 cm / Ø 14,5 cm, L: 32 cm / Ø 19,5 cm, L: 38,5 cm

set de 3 composé de 3 tamis :

Ø 8,5 cm, L: 22,5 cm / Ø 14,5 cm, L: 32 cm / Ø 19,5 cm, L: 38,5 cm

	Ø cm	→ cm
74707	8,5/14,5/19,5	22,5/32/38,5



3 teilig  
3 pcs. set



**Seiher**

strainer  
colador  
passoire



	Ø cm	↑ cm
74708	28,5	10

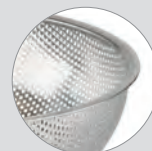



**Back- / Frittierlöffel**  
 skimmer / spider  
 espumadera para fritos  
 écumoire à friture



elektropoliert, sehr stabile Ausführung  
 electro polished, heavy gauge  
 electro pulido, alta calidad  
 poli électrolythique, qualité extra

	Ø cm	→ cm
74402	16	48
74404	20	54



**Gazespitzsieb**  
 conical strainer with wire gauze  
 colador chino de malla  
 chinois renforcé avec maille fine



hochglanzpoliert, mit rundem Hohlgriff, ca. 9 Löcher pro 1 cm<sup>2</sup>  
 mirror polished finish, 9 holes per 1 cm<sup>2</sup>  
 pulido acabado brillante, mango hueco, 9 agujeros por 1 cm<sup>2</sup>  
 brillant, manche creux, 9 trous pour 1 cm<sup>2</sup>

	Ø cm	↑ cm	Griff / handle cm
88717	25	19	24

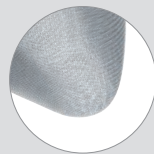

**Pommes-Frites-Seiher**  
 fry dripping tray  
 escurridor de fritos  
 égouttoir à friture



herausnehmbarer Locheinsatz, mit Handgriff  
 removable drainer, with handle  
 fondo de colador desmontable, con asa  
 fond démontable, avec poignée

	Ø cm	↑ cm
00785	39	19



**Salzstreuer**  
 salt shaker  
 salero  
 salière



Pommes-Frites Streuer mit Schraubkappe  
 for french fries, cover to screw  
 para patatas fritas, tapa de rosca  
 pour les frites, couvercle à visser

	Ø cm	↑ cm	
00772	8	17	stainless steel
00779	8	17	aluminium



**Spitzsieb**  
conical strainer  
colador cónico  
chinois



mit Lochung Ø 1,5 mm, auch in der Kegelspitze, mit Flachstiel, mit Stützstiel zum Einhängen in den Topfrand

with Ø 1,5 mm holes (including the tip), with flat handle, with supporting hook  
con agujeros finos de Ø 1,5 mm (incluida la punta), con mango plano y gancho  
perforations fines 1,5 y compris à la pointe, manche plat et crochet

	Ø cm	↑ cm	Griff / handle cm
00771	23	18	16,5



**Wasserbadschüssel**  
bain marie bailing bowl  
cazo para baño maría  
récipient bain-marie



hochglanzpoliert, mit Drahtgriff Ø 5 mm  
mirror polished finish, with wire handle Ø 5 mm  
inox pulido brillante, mango varilla Ø 5 mm  
inox brillant, manche fil épaisseur Ø 5 mm

	Ø cm	↑ cm	Griff / handle cm	ltr.
74731	18	9	15	1,5



Anwendungsbeispiel, Topf ≥ 20 cm  
Application Example, pot ≥ 20 cm



**Likör- und Fondanttrichter**  
confectionery funnel  
embudo dosificador  
entonnoir à piston



ergonomischer Griff aus Kunststoff, mit 3 Düsen 2, 4, 6 mm, inkl. Ständer u. Auffangschale  
ergonomic plastic handle, with 3 different nozzles 2, 4, 6 mm, incl. wire rack a. dripping dash  
mango ergonómico con 3 boquillas, 2, 4, 6 mm, incl. pie de alambre y bandeja recoge gotas  
manche plastique ergonomique, 3 douilles de 2, 4 et 6 mm, inclut pied avec ramasse-gouttes

	Ø cm	↑ cm	ltr.
77338	20	34	1,5



**Gemüsehobel, Mandoline**  
mandolin  
mandolina  
mandoline



mit 7 verschiedenen Klingen (Breite 10 cm), Anti-Rutsch-Gestell, Schutzabdeckung  
with 7 interchangeable blades (width 10 cm), non-slip folding stand, safety guard  
con 7 cuchillas intercambiables (corte 10 cm), pie plegable anti-deslizante, carro de seguridad  
7 peignes interchangeables (largeur 10 cm), pied repliable anti-glisse, chariot

	cm	↑ cm
88688	40,5 x 12	5 / 25



**A** 7 verschiedene Klingen  
7 interchangeable blades  
**B** Praktische Transportbox  
Practical transport box



**Schaumspeisering**  
mousse ring  
aro redondo para semifríos  
cercle à mousse rond

**matt poliert, fugenlos**  
satin polished finish, seamless  
acabado satinado sin soldadura  
mat satiné, sans soudure



	Ø cm	↑ cm
00098	6	4,5
00099	7	4,5
00092	8	4,5
00093	10	4,5
00094	12	4,5



**Schaumspeiseringe, 5er Set**  
mousse ring, 5 pcs.  
juego aros para emplatar o para semifríos  
jeu de cercles à mousse inox, ronds

**5-teilig: 4 Formen + 1 Verdichter, matt poliert, fugenlos**  
5 pcs. set: 4 shapes and 1 pusher, satin polished finish, seamless  
juego de 5 piezas: 4 aros redondos y 1 pulsador, para dar forma, satinado sin soldadura  
jeu de 5 pièces: 4 cercles et 1 poussoir. Idéal pour dressage sur assiette ou mousse, mat satiné, sans soudure



	Ø cm	↑ cm
00110	6	4,5
00113	8	4,5



**Messbecher**  
graduated jug  
jarra graduada  
pichet gradué

**außen hochglanzpoliert, innen matt poliert, mit Maßskalierung außen**  
outside mirror polished finish, inside satin polished finish, with stamped liter scale  
exterior pulido brillante, interior satinado con escalado en litros  
extérieur brillant, intérieur satiné, graduation en litres



	Ø cm	↑ cm	ltr.
30045	10	14	1

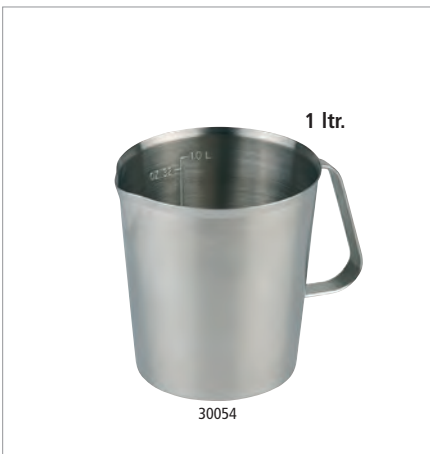

**Mess- / Universalkanne**  
graduated jug  
jarra medidora universal  
pichet mesureur universel

**matt poliert, mit Maßskalierung innen**  
satin polished finish, with stamped liter scale inner  
acabado satinado, con graduación en el interior  
mat, graduations à l'intérieur



	Ø cm	↑ cm	ltr.
30054	12	13	1
30055	14	17	2





Messbecher „PRO“

measuring cup  
jarra graduada  
pichet gradué



mit geschlossenem Griff, mit geprägter Maßskalierung außen, l- und ml-Liter-Einteilung  
with closed handle, with stamped printed liter and ml scale

	Ø cm	↑ cm	ltr.
30046	9	14	0,5
30047	12	16,5	1,0
30048	15	20,5	2,0
30049	17	23,5	3,0
30057	20	25,5	5,0



Messbecher „STACKABLE“

measuring cup  
jarra graduada  
pichet gradué



mit offenem Griff und geprägter Maßskalierung außen, platzsparend stapelbar  
with open handle and embossed dimension scaling on the outside, space-saving stackable  
con asa abierta y escala de dimensiones en relieve en el exterior, apilable para ahorrar espacio  
avec une poignée ouverte et une échelle de dimensions en relief à l'extérieur, empilable et peu encombrante

	Ø cm	↑ cm	ltr.
30059	7	12	0,25



offener Griff open handle      einfaches Eingießen easy pouring      stapelbar stackable

	Ø cm	↑ cm	ltr.
30061	9	14	0,5
30062	12	16,5	1,0
30063	15	20,5	2,0



Rührbecher mit Deckel

stirring cup with lid  
vaso agitador con tapa  
tasse à remuer avec couvercle



inklusive Spritzschutz und geprägter Maßskalierung außen, platzsparend stapelbar  
included splash guard with open handle and embossed dimension scaling on the outside, space-saving stackable

protección contra salpicaduras incluida con asa abierta y escala de dimensiones en relieve en el exterior, apilable para ahorrar espacio

protection contre les éclaboussures incluse avec une poignée ouverte et une échelle de dimensions en relief à l'extérieur, empilable et peu encombrante

	Ø cm	↑ cm	ltr.
30058	12,5	16	1,0



Griff mit Daumenmulde handle with thumb recess      mit Silikonring with silicone ring



**Dariolformen, 2er Set**

dariol moulds, 2 pcs.  
juego 2 flaneras  
jeu de 2 moules à flan



hochglanzpoliert  
mirror polished finish  
acabado brillante  
brillant

	Ø cm	↑ cm	ltr.
00106	6,5	4,5	0,1



**Tortenring**

cake setting ring  
aro de tarta  
cercle à gâteaux



stufenlos verstellbar  
adjustable  
ajustables  
ajustables

	Ø cm	↑ cm	
00040	16,5 - 32	7	ohne Griff / without handle



**Backform**

baking pan  
marco pastelero  
forme à gateaux



stufenlos verstellbar, aus flexiblem Edelstahl  
adjustable  
ajustable  
ajustable

	cm	↑ cm
00042	19 x 28 - 34 x 54	5



**Ausstellblech / Thekenblech**

display tray  
bandeja pastelera  
plaque pâtissière



hitzebeständig bis 230°C  
heat-resistant up to 230°C  
resistente al calor hasta 230 °C  
résistant à la chaleur jusqu'à 230°C

	cm	↑ cm
13377	40 x 25	2
13378	48 x 32	2
13379	60 x 40	2



**Mehlschaufel „PRO“**

scoop  
pala  
pelle à farine



**stehende Schaufel, auch für Flüssigkeiten geeignet**  
standing scoop, also applicable for liquids  
pala, apto también para líquidos  
adaptée pour poudres et liquides

	cm	↑ cm	ltr.	Farbe / Colour
00610	25 x 9	4,5	0,25	White
00611	31 x 12	5,5	0,5	White
00612	35 x 13	6	0,7	White



**Seiher**

strainer  
colador  
passoire



**mit 2 Muschelgriffen**  
with 2 shell shaped grips  
con dos asas  
à 2 anses moulées

	Ø cm	↑ cm
00780	36	19



**Backhandschuhe**

baking mittens  
manoplas de panadero  
gants de boulanger

**Leder, gefüttert, Einheitsgröße, mit Stulpen, extrem hitzebeständig bis 250°C**  
leather, inner lining, one size, with cuffs, extremely heat resistant up to 250°C  
cuero interior forrado, talla única, resiste a temperaturas hasta 250°C  
cuir intérieur doublé, taille unique, résiste à maxi 250°C

	→ cm
88090	45



**Pizzaschaufel**

pizza peel  
pala de pizza  
pelle à pizza



	cm	→ cm
88080	35 x 30,5	90
88081	35 x 30,5	130



**Schaufel „ECO“**

scoop  
pala  
pelle



stabil und bruchsicher  
stable and unbreakable  
estable e irrompible  
stable et incassable

	→ mm	ltr.
00694	180	0,110
00695	240	0,230
00696	310	0,470
00697	330	0,725



Zum schnellen und zielgerichteten Abfüllen von Lebensmitteln  
for fast and targeted filling of foodstuffs



**Profi-Eimer**

bucket  
cubo  
seau



mit Ausgießer und geprägter Maßskalierung innen  
with spout and embossed dimension scaling inside  
con pico y escala de medición en relieve en el interior  
avec bec verseur et échelle de mesure en relief à l'intérieur

	Ø cm	↑ cm	ltr.	Farbe / Colour
30075	28,5	28,5	10,5	White
30076	33,0	32,0	17,0	White
30077	28,5	28,5	10,5	Black
30078	33,0	32,0	17,0	Black



mit Griff  
with handle

Maßskalierung innen  
dimension scaling inside

Auslaufnase für sicheres Handling  
discharge nose for safe handling



**Eier-Box**

eggs box  
caja para huevos  
boîte à oeufs



mit luftdichtem Deckel, für 4 Lagen à 30 Eier, Lieferung inkl. 8 Lagen, Größe Lage: 28 x 28 cm  
with airtight cover, capacity: 4 trays of 30 eggs, delivery with 8 trays, size of tray: 28 x 28 cm  
capacidad para 4 bandejas de 30 huevos, tapa hermética, se entrega con 8 bandejas, formato bandejas 28 x 28 cm, apto para lavavajillas  
pour 4 plateaux de 30 oeufs chacun, apte pour 4 plateaux plats, couvercle hermétique, livré avec 8 plateaux, dimension plateau 28x28 cm, lavable en lave-vaisselle

	cm	↑ cm	GN
82419	35,4 x 32,5	20	2/3



**NEW**

Ø 6 cm



30065

Ø 10 cm



30067

Ø 12 cm



30068

Ø 17 cm



30070

inkl. Sieb  
incl. strainer

Ø 21 cm



30071

inkl. Sieb  
incl. strainer

**Trichter „PROFI“**

funnel  
embudo  
entonnoir

mit Öse  
with eyelet  
con ojal  
avec œillet



	Ø cm	Ø mm Durchlass	
30065	6	8	
30066	8	11	
30067	10	12	
30068	12	12	
30069	14	15	
30070	17	17	mit Sieb / incl. strainer
30071	21	20	mit Sieb / incl. strainer



30066

erleichtert das Einfüllen  
facilitates filling



30065

Anwendungsmöglichkeit  
applicability



30070

mit einsetzbarem Sieb  
incl. insertable strainer



30071

mit einsetzbarem Sieb  
incl. insertable strainer



2 Pressringe für Zitrone und Limette

**Limetten- / Zitronenpresse**  
lime- / lemonpress  
exprimidor de limón / lima  
presse citron



	cm	↑ cm
93214	21 x 7	5



**Limettenpresse**  
lime press  
prensa de limón  
presse citron



	cm	↑ cm
93189	21 x 7	5



**Zitruspresse**  
citrus squeezer  
exprimidor cítricos  
presse-citron



hochglanzpoliert, 2-teilig  
mirror polished finish, 2 pcs.  
pulido brillante, 2 piezas  
brillant, 2 pièces

	Ø cm	↑ cm	ltr.
71431	12 / 17	10,5	0,35



77350

77352

**Pinsel**  
brush  
brocha  
pinceau pâtissier



weißgebleichte, naphtalinfreie Borsten, temperaturbeständig von -40°C bis +95°C  
bleached bristles, heat-resistant from -40°C to +95°C  
cerdas blanqueadas, resistencia térmica -40°C hasta +95°C  
soies blanchies sans naphtaline, résistance de - 40°C à + 95°C

	cm	→ cm
77350	4 x 1	23,5
77352	6 x 1	24



NEW

einhängbar  
hookable

**Panierstation, 3-teilig**  
breading set, 3 pcs. set  
estación de empanado, set de 3  
station de panure, set de 3



zum Panieren von Fleisch, Gemüse, Käse etc.  
for breading meat, vegetables, cheese etc.  
para empanar carne, verduras, queso, etc.  
pour paner la viande, les légumes, le fromage etc.

	cm	↑ cm
66904	45,5 x 18	2,5



**Bonspieß**  
bill spike  
pinchanotas  
pique-bons



Spieße aus flexiblem Kunststoff, mit stumpfen Enden zur Unfallverhütung  
spikes made of flexible plastic, with blunt ends to prevent accidents  
pinchos de plástico flexible  
piques en plastique flexible

	cm	↑ cm
88855	9 x 5,5	10,5



**Bonleiste**  
bill rail  
portafichas  
barre porte-bons



matt poliert, mit Kugel-Greifsystem, zur Wandmontage geeignet, auch mit Magneten nutzbar  
satin polished finish, small balls hold the bills, suited for wall fastening, can also be used with magnets  
acabado satinado, con sistema de bolas para colgar las notas para fijar en la pared, puede usarse con imán  
mat satiné, avec billes pour fixer sans effort tous types de fiches et papiers, peut se fixer sur plaque aimantée

	cm	↑ cm
88900	40 x 8	2
88901	50 x 8	2
88902	60 x 8	2



**Magnet-Messerhalter**  
magnetic knife rack  
barra magnética para cuchillos  
barre aimantée pour couteaux



mit 2 Magnetschienen und Haken, aus massivem Kunststoff, zur Wandmontage geeignet, Lieferung ohne Deko  
with 2 magnet racks and hooks, strong plastic, suited for wall fastening  
con 2 railes magnéticos y ganchos, plástico macizo, fijación en pared  
avec 2 rails aimantés et crochets, plastique robuste, fixation murale

	→ cm
88911	45
88912	60



**Folien-Abreißvorrichtung**  
clingfilm tear-off-dispenser  
dispensador de film  
dérouleur de film



mit Abreißkante / Säge-Messer, für Endlosfolie, als Tischgerät oder Wandgerät verwendbar  
with saw, for endless rolls, can be fixed on the wall  
con sierra para rollo de film continuo, se puede fijar en la pared  
avec lame dentée pour rouleau de film, peut être fixé au mur

	cm	↑ cm	
88288	34 x 16	9	für Folienbreite 30 cm / for film width 30 cm para film ancho 30 cm / pour film largeur 30 cm
88287	49 x 16	9	für Folienbreite 45 cm / for film width 45 cm para film ancho 45 cm / pour film largeur 45 cm



**Schneidbrettständer**  
cutting board rack  
soporte para tablas  
rack pour planches à découper



für 6 Schneidbretter bis 25 mm Stärke, Lieferung ohne Deko  
for 6 chopping boards up to 25 mm thickness  
para 6 tablas de corte de 25 mm  
pour 6 planches de 25 mm

	cm	↑ cm
88903	27 x 31	28



**Eiswaffel-Ständer**  
cornet stand  
soporte cucuruchos  
support à cornets



matt poliert, mit 4 Löchern, 2 x Ø 31 mm + 2 x Ø 26 mm  
satin polished finish, with 4 holes, 2 x Ø 31 mm + 2 x Ø 26 mm  
acero inoxidable con 4 agujeros 2 x Ø 31 mm + 2 x Ø 26 mm  
inox, 4 trous - 2 x Ø 31 mm + 2 x Ø 26 mm

	cm	↑ cm
11881	27,5 x 9,5	9



**Eisportionierer**  
ice cream scoop  
cuchara para helado  
cuillère à glace



hochglanzpoliert, mit Edelstahlfeder (physikalisch bedingt nicht korrosionsbeständig)  
mirror polished finish, spring steel, spring is not stainless  
pulido brillante, muelle de acero especial, no resistente al óxido  
poli brillant, ressort acier spécial, non résistant à l'oxydation

	Ø cm	→ cm	ltr.
71006	6,5	23,5	1/12
71005	6,0	22,5	1/16
71004	5,5	22,0	1/20
71003	5,0	22,0	1/24
71002	5,0	21,5	1/30
71001	4,5	21,0	1/36



**Quetschflasche „MINI“, 4er Set**  
squeeze bottle, 4 pcs.  
bote dosificador flexible, 4 pz.  
bouteille verseuse souple, 4 pc.



mit Schraubdeckel und Verschlusskappe, ideal für Dressing und Saucen  
with tight-screw and cap, ideal for dressing and sauce  
con tapa de rosca y tapón, ideal para aliño y salsas  
avec couvercle à visser et bouchon de fermeture, idéal pour vinaigrette et sauces



	Ø cm	↑ cm	ltr.	pcs.
93225	3,0	8,5	0,03	4
93226	3,5	9,5	0,05	4



**NEW**

93259 1,025 ltr. 93260 1,025 ltr. 93261 1,025 ltr.

**Quetschflasche**  
squeeze bottle  
bote dosificador flexible  
bouteille verseuse souple

**mit Schraubdeckel und Verschlusskappe, ideal für Dressing und Saucen**  
with tight-screw and cap, ideal for dressing and sauce  
con tapa de rosca y tapón, ideal para aliño y salsas  
avec couvercle à visser et bouchon de fermeture, idéal pour vinaigrette et sauces

PE POLYETHYL

	Ø cm	↑ cm	ltr.	Farbe / Colour
93259	8	26,5	1,025	White
93260	8	26,5	1,025	Yellow
93261	8	26,5	1,025	Red

große „Öffnung“  
big „mouth opening“

93155 0,65 ltr. 93156 0,65 ltr. 93157 0,65 ltr.

**Quetschflasche**  
squeeze bottle  
bote dosificador flexible  
bouteille verseuse souple

**mit Schraubdeckel und Verschlusskappe, ideal für Dressing und Saucen**  
with tight-screw and cap, ideal for dressing and sauce  
con tapa de rosca y tapón, ideal para aliño y salsas  
avec couvercle à visser et bouchon de fermeture, idéal pour vinaigrette et sauces

PE POLYETHYL

	Ø cm	↑ cm	ltr.	Farbe / Colour
93155	6,5	24	0,65	Yellow
93156	6,5	24	0,65	Red
93157	6,5	24	0,65	White

93154

**Quetschflasche**  
squeeze bottle  
bote dosificador flexible  
bouteille verseuse souple

**ideale Größe, um Speiseteller mit Saucen zu verzieren, mit Verschlusskappe**  
ideal size to garnish plates with sauces, with cap  
tamaño ideal para decorar platos con salsas, con tapón  
taille idéale pour décorer assiettes avec des sauces, avec bouchon

PE POLYETHYL

	Ø cm	↑ cm	ltr.
93154	5	16	0,2
93163	6	21	0,35

NEW



93253  
0,49 ltr.



93251  
0,26 ltr.



93258  
0,76 ltr.

**Quetschflasche, 6er Set**

squeeze bottle, 6 pcs.  
bote dosificador flexible, set de 6  
bouteille verseuse souple, set de 6



**mit Schraubdeckel und Verschlusskappe, ideal für Dressing und Saucen**

with tight-screw and cap, ideal for dressing and sauce

con tapa de rosca y tapón, ideal para aliño y salsas

avec couvercle à visser et bouchon de fermeture, idéal pour vinaigrette et sauces

	Ø cm	↑ cm	ltr.	Farbe / Colour	pcs.
93250	5	18,0	0,26		6
93251	5	18,0	0,26		6
93252	5	18,0	0,26		6
93253	7	20,0	0,49		6
93254	7	20,0	0,49		6
93255	7	20,0	0,49		6
93256	7	26,5	0,76		6
93257	7	26,5	0,76		6
93258	7	26,5	0,76		6



mit Verschlusskappe  
with cap



große „Öffnung“  
big „mouth opening“

NEW



93270  
0,35 ltr.



93271  
0,35 ltr.



93272  
0,35 ltr.



93273  
0,75 ltr.



93274  
0,75 ltr.



93275  
0,75 ltr.

**Quetschflasche „NON DRIP“**

squeeze bottle  
bote dosificador flexible  
bouteille verseuse souple



**mit Schraubdeckel und Verschlusskappe, ideal für Dressing und Saucen**

with tight-screw and cap, ideal for dressing and sauce

con tapa de rosca y tapón, ideal para aliño y salsas

avec couvercle à visser et bouchon de fermeture, idéal pour vinaigrette et sauces

	Ø cm	↑ cm	ltr.	Farbe / Colour
93270	5,5	21,0	0,35	
93271	5,5	21,0	0,35	
93272	5,5	21,0	0,35	
93273	7,0	25,5	0,75	
93274	7,0	25,5	0,75	
93275	7,0	25,5	0,75	



mit Skalierung  
with scaling



tropffrei  
non drip



**Dosierspender**  
dispenser  
dispensador de salsa  
doseur à sauce



	cm	↑ cm	ltr.	GN
93280	17,6 X 16,2	27	2,6	1/6



**Dosierpumpe / dosing pump / riser tube / bomba de salsa, sola / pompe à sauce**

**Hubvolumen 30 ml**  
swept volume 30 ml  
cada dosis 30 ml  
30 ml par dose

	cm	↑ cm	ltr.	
93281	12,5 X 4,5	26	0,30	fits to 93280



**Dosierspender**  
dispenser  
dispensador de salsa  
doseur à sauce



	cm	↑ cm	ltr.
93151	13 x 7,5	27	1,25



**Dosierpumpe / dosing pump / riser tube / bomba de salsa, sola / pompe à sauce**

**Hubvolumen 30 ml**  
swept volume 30 ml  
cada dosis 30 ml  
30 ml par dose

	Ø cm	↑ cm
88271	4,5	40



**Gewürzkasten**  
condiment container  
especiero  
boîte à épices ou ingrédients



**matt poliert, 4 herausnehmbare Einsatzschalen je 0,5 l, Scharnierdeckel aus Acryl**  
satin polished finish, 4 removable inserts each 0,5 ltr., acrylic lid  
acabado mate, 4 contenedores extraíbles de 0,5 L cada uno, tapa con bisagras de acrílico  
poli mat, 4 compartiments amovibles de 0,5 l chacun, couvercle rabattable en acrylique

	cm	↑ cm	ltr.
71700	31 x 15,5	9,5	4 x 0,5

**Einsatzschale / insert / contenedor 0,5 L / récipient 0,5 L**

	cm	↑ cm	ltr.
71701	14 x 7,5	7	0,5



NEW

# Pizzaform

11 sizes



**Pizzaform**  
pizza dish  
molde de pizza  
moule à pizza



**Blaublech, nicht beschichtet, lange Lebensdauer, hitzebeständig bis 360 °C**  
metal sheet, without coating, long endurance, heat resistant up to 360 °C  
chapa azul, sin revestimiento, larga vida útil, resistente al calor hasta 360 °C  
métal, sans revêtement, longue durée de vie, à la chaleur jusqu'à 360 °C

	Ø cm	↑ cm	* mm
73502	16 - 18	2,5	1
73503	18 - 20	2,5	1
73504	20 - 22	2,5	1
73505	22 - 24	2,5	1
73506	24 - 26	2,5	1
73507	26 - 28	2,5	1
73508	28 - 30	2,5	1
73509	30 - 32	2,5	1
73510	34 - 36	2,5	1
73511	38 - 40	2,5	1
73513	48 - 50	3,0	1



stapelbar  
stackable



NEW



**Gestell für Pizzaformen**

rack for pizza pans  
rejilla para pizzas  
support pour moules à pizza



Edelstahlgestell zusammenklappbar für Pizzaformen Ø 28 cm,  
Abstand zwischen den Ebenen 5,5 cm

foldable stainless steel rack for pizza dishes ø 28 cm,  
distance between the levels 5.5 cm

rejilla plegable de acero inoxidable para moldes de pizza de Ø 28 cm,  
distancia entre los niveles 5,5 cm

support en acier inox pliable pour les moules à pizza de Ø 28 cm,  
distance entre les niveaux 5,5 cm

	cm	↑ cm
73515	26 x 25	26



Backofen geeignet  
suitable for oven



Pizzaform für Ø 28 cm  
pizza dish for Ø 28 cm



**Pizzaform / pizza dish / molde de pizza / moule à pizza**

	Ø cm	↑ cm	mm
73507	26 / 28	2,5	1

**Korkuntersetzer**

cork mat  
salvamanteles  
dessous-de-plat liège



ideal für Servier- und Eisenpfannen

ideal for iron pan

ideal para servir en sartenes de chapa

idéal pour présenter les poêles forgées sur table



	Ø cm	↑ cm
73750	24	2



**Teig- und Pizzaballenbehälter**  
dough and pizza ball container  
recipiente para masa y bolas de pizza  
récipient à pâte et boules à pizza



**Innenmaß 56,5 x 36,5 cm, H: 7 cm**  
inner dimension 56,5 x 36,5 cm, H: 7 cm  
medida interior 56,5 x 36,5 cm, H: 7 cm  
dimension intérieure 56,5 x 36,5 cm, H: 7 cm

	cm	↑ cm	ltr.
82440	60 x 40	7,5	14

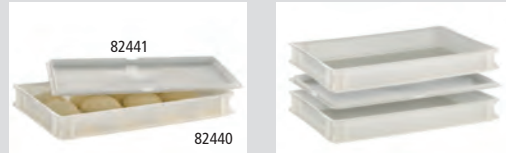

stapelbar  
stackable

passender Deckel / fitting lid / tapa adecuada / couvercle approprié

	cm	↑ cm
82441	60 x 40	1



**Pizzaform**  
pizza dish  
molde de pizza  
moule à pizza



**Blaublech, rechteckig, Rand umgelegt, hitzebeständig bis 360 °C**  
blue steel baking sheet, rectangular, heat resistant up to 360 °C  
chapa azul rectangular, borde plgado, resistente al calor hasta 360 °C  
métal, rectangulaire, bord plié, à la chaleur jusqu'à 360 °C

	cm	↑ cm
88256	60 x 40	2,5



**Pizzaschneider „BLUE“**  
pizza cutter  
cortador de pizza  
coupe-pizza



**ergonomischer Griff**  
ergonomic handle  
mango ergonómico  
manche ergonomique

	∅ cm	→ cm
88949	10	20



**Aufsteller „ACHTUNG RUTSCHGEFAHR“**  
stand  
letrero  
panneau



	cm	↑ cm	Farbe / Colour
71421	30 x 63	63	Yellow









# Hauben & Zubehör

covers & accessories  
campanas & accesorios  
cloches & accessoires



# QUALITÄTSHAUBEN

11042  
GN 1/111041  
GN 1/211043  
GN 1/311044  
GN 2/411041  
GN 1/211042  
GN 1/1

## GN Abdeckhaube

GN cover  
GN cubierta  
GN cloche



passend für GN Tablett, glasklarer Kunststoff, nahezu bruchfest

suitable for GN trays, clear plastic, nearly unbreakable

apto para bandejas GN, plástico transparente, muy resistente a la rotura

pour bacs et plateaux GN, plastique transparent, très résistant à la casse

	cm	↑ cm	∕ mm	GN
11043	32,5 x 17,6	10,5	3	1/3
11044	53,0 x 16,2	10,5	3	2/4

	cm	↑ cm	∕ mm	GN
11041	32,5 x 26,5	9,5	3	1/2
11042	53,0 x 32,5	9,5	3	1/1



stapelbar  
stackable



## GN 1/1 Haube „HOCHSTAPLER“

GN 1/1 cover  
GN 1/1 campana  
GN 1/1 cloche



glasklarer Kunststoff, Tablett fixiert sich auf der Haube - kein Rutschen möglich, nahezu bruchfest

clear plastic, tray fixes itself on the cover and can not slip off, nearly unbreakable

plástico transparente, la bandeja se fija a la tapa para que no se deslice, muy resistente a la rotura

en plastique transparent, le plat se fixe sur le dessous de la cloche pour ne pas glisser, très résistant à la casse

	cm	↑ cm	GN	fits to
11305	53 x 32,5	9	1/1	11300, 11290, 11295



## GN Kuppelhaube

GN cover  
GN cúpula  
GN cloche bombée



glasklarer Kunststoff, Griff aus Zinkdruckguss

crystal clear plastic, die-cast zinc knob

plástico transparente, asa de zinc fundido a presión

plastique transparente, poignée en zinc moulé sous pression

	cm	↑ cm	GN	
11021	33 x 28	17	1/2	geschlossen / totally closed cerrada / totement fermée
11022	33 x 28	17	1/2	mit Front-Ausschnitt / one long side cut out gran apertura frontal grande ouverture frontale
11026	54 x 33	20	1/1	geschlossen / totally closed cerrada / totement fermée
11027	54 x 33	20	1/1	mit Front-Ausschnitt / one long side cut out gran apertura frontal grande ouverture frontale
11028	54 x 33	20	1/1	mit seitlichem Ausschnitt / one small side cut out pequeña apertura lateral petite ouverture latérale



stapelbar  
stackable



GN 1/1  
and  
GN 1/2

**GN Rolltophaube**

GN rolltop cover  
GN campana rolltop  
GN cloche rolltop



patentiert, passend für GN-Behälter, -Tablets, etc., leichtgängig auf- und zuklappbar 90°  
patented, suitable for GN trays, solid quality, 90° opening  
patentada, para bandejas GN, apertura 90°  
brevetée, pour plateaux GN, ouverture 90°

	cm	↑ cm	GN	
11008	53,0 x 32,5	19	1/1	vergoldeter Griff / gold plated handle pomo dorado / bouton doré
11010	53,0 x 32,5	19	1/1	verchromter Griff / chrome plated handle pomo cromado / bouton chromé
12008	32,5 x 26,5	15	1/2	vergoldeter Griff / gold plated handle pomo dorado / bouton doré
12010	32,5 x 26,5	15	1/2	verchromter Griff / chrome plated handle pomo cromado / bouton chromé



GN 1/1

**GN 1/1 Rolltophaube „SUNDAY“**

GN 1/1 rolltop cover  
GN 1/1 campana rolltop  
GN 1/1 cloche rolltop



Griff ABS verchromt, leichtgängig auf- und zuklappbar  
handle chrome plated, easy to open and close  
asa material ABS cromado, fácil de abrir y cerrar  
poignée matériel ABS chrome, ouverture et fermeture faciles

	cm	↑ cm	GN
11016	53,0 x 32,5	19	1/1



GN 1/1

**GN 1/1 Rolltop-Haube**

GN 1/1 rolltop cover  
GN 1/1 campana abatible  
GN 1/1 cloche basculante



verchromter Zinkdruckguss-Griff / chrome plated metal handle / mango cromado de fundición a presión de zinc / poignée en zinc moulé sous pression chromé

	cm	↑ cm	GN
11018	53,0 x 32,5	19	1/1

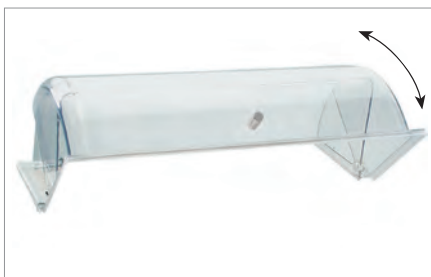

**Rolltophaube „FOCUS“**

rolltop cover  
campana abatible  
cloche basculante



verchromter Griff / chrome plated handle / pomo cromado / bouton chromé

	cm	↑ cm
09013	44 x 33,5	17



GN 1/1

**GN 1/1 Haube**

GN 1/1 cover  
GN 1/1 campana  
GN 1/1 cloche



klappbar, passend für GN 1/1-Behälter, GN 1/1-Tablets, etc., nahezu bruchfest  
suitable for GN 1/1 chafing dish, GN 1/1 trays, GN 1/1 pans  
plegable, para cubetas GN 1/1, bandejas GN 1/1 etc., muy resistente a la rotura  
pliable, pour bacs GN 1/1, plateaux GN 1/1 etc., très résistant à la casse



klappbar  
adjustable

	cm	↑ cm	GN
11013	53,0 x 32,5	6	1/1





### Rolltophaube

rolltop cover  
campana abatible  
cloche basculante

SAN  
KUNSTSTOFF



glasklarer Kunststoff, leichtgängig auf- und zuklappen 90°  
solid quality, to be opened 90°  
plástico transparente, apertura 90°  
plastique transparent résistant, ouverture 90°

	Ø cm	↑ cm	
18388	38	20	mit verchromtem Kugelgriff / with chrome plated handle con pomo cromado / avec bouton chromé
18387	38	20	mit vergoldetem Kugelgriff / gold plated handle pomo dorado / bouton doré
18380	50	26	mit verchromtem Zylindergriff / chrome plated handle pomo cromado / bouton chromé



### Frischhalte-Haube

cover  
campana  
cloche bombée

SAN  
KUNSTSTOFF



glasklar, Griff verchromt, schwere, stabile Ausführung  
transparent, chrome knob, heavy stable quality  
transparente, asa cromada, alta estabilidad  
transparente, anse chromée, très stable

	Ø cm	↑ cm	fits to
15350	16,5	10	15130
15351	20,5	10	15131, 15141, 15271





# SUPER DOME



## Frischhalte-Haube „SUPER DOME“

cover  
campana  
cloche

schwere, glasklare Qualität  
stable, crystal clear quality  
muy resistente y transparencia cristalina  
haute résistance et transparence



	Ø cm	↑ cm
06525	30	40

passende Servier- Tortenplatten / suitable cake stands / porta pasteles compatibles / présentoirs à gâteaux compatibles

	Ø cm	↑ cm	fits to	Farbe / Colour
85051	30,5	9,0	06525	
85052	30,5	17,0	06525	
00468	31,0	3,5	06525	
85112	32,0	3,5	06525	
33294	33,0	8,0	06525	
33295	33,0	16,0	06525	



Servierbeispiel  
presentation example

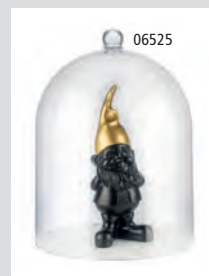

Präsentationsmöglichkeiten  
presentation examples





11051 Ø 22 cm



11052 Ø 24 cm



11053 Ø 28 cm



11054 Ø 28,5 cm

### Tellerabdeckhaube

plate cover  
cubierta para plato  
couvrele pour assiette



passend für unterschiedliche Tellergrößen  
suitable for different plate sizes  
aptas para diferentes tamaños de platos  
aptes pour différentes tailles d'assiettes

	Ø cm	↑ cm	passend für unterschiedliche Tellergrößen / suitable for different plate sizes
11051	22,0	7,0	Ø 21,5 cm
11052	24,0	7,5	Ø 22,5 - 23,0 cm
11053	28,0	6,5	Ø 26,0 - 26,5 cm
11054	28,5	6,5	Ø 27,0 - 27,5 cm



Servierbeispiele  
presentation example



passende Hauben  
suitable covers 11051, 11052

### Frischhalte-Haube

cover  
campana  
cloche



schwere, glasklare Qualität  
stable, crystal clear quality  
calidad estable y transparencia cristalina  
qualité stable et clarté cristalline



Ø 21cm

tray  
84942

06520

Ø 30cm

3 sizes available Ø 21 - Ø 30 - Ø 36 cm

	Ø cm	↑ cm	fits to
06519	21	17	84941, 84942
06520	30	22	85034, 84177, 83891, 83890, 83884, 998, 975, 469, 468, 463, 462, 46
06521	36	27	84945, 84946



stapelbar  
stackable



06512

**Frischhalte-Haube**

cover  
campana  
cloche



glasklar, schwere stabile Ausführung, stapelbar  
clear, heavy stable quality, stackable  
transparente, alta estabilidad, apilable  
transparente, très stable, empilable

	Ø cm	↑ cm	
06512	30	11,5	mit verchromtem Griff / with chrom plated handle con botón cromado / avec bouton chromé
06517	30	11,5	mit verchromtem Griff / with chrom plated handle con botón cromado / avec bouton chromé



06515

**Frischhalte-Haube**

cover  
campana  
cloche



glasklar, schwere stabile Ausführung, stapelbar  
clear, heavy stable quality, stackable  
transparente, alta estabilidad, apilable  
transparente, très stable, empilable

	Ø cm	↑ cm	
06510	30	11,5	
06515	33	12,5	



**Frischhalte-Haube**

cover  
campana  
cloche



	Ø cm	↑ cm	
06501	30	11	
06504	30	9,5	
06506	30	7	



06501

**Frischhaltehauben, 2er Set**

covers, 2 pcs. set  
campanas, set de 2  
cloches, pack de 2



	Ø cm	↑ cm	
40752	30	11	

NEW



## Frischhalte- Haube

cover  
campana  
cloche

	Ø cm	↑ cm	fits to
11055	23	12	00827



Set 00827

glasklar, schwere stabile Ausführung  
clear, heavy stable quality

NEW



## Frischhalte- Haube

cover  
campana  
cloche

	cm	↑ cm	fits to
11056	25 x 12	10	00828



Set 00828

glasklar, schwere stabile Ausführung  
clear, heavy stable quality

06401



06701

## Frischhalte-Haube

cover  
campana  
cloche

	cm	↑ cm
06401	29,5 x 13,5	10
06701	21,6 x 16,2	7



18621

Lieferung ohne Tablett  
delivery without tray

18121

## Frischhalte-Haube

cover  
campana  
cloche

	Ø cm	↑ cm
18621	18	8,5
18121	35,5 x 27,8	7,5





Deckel „FRIDA“

cover  
tapa  
couvricle



	Ø cm	↑ cm	fits to	€
84962	9	2,5	84930, 84931	
84963	13	2,5	84605, 84606	
84964	16	2,5	84607, 84608	

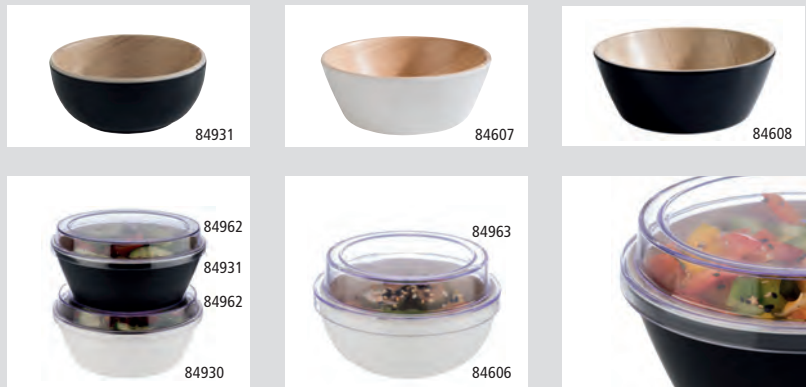

stapelbar / stackable



Deckel „FRIDA“

cover  
tapa  
couvricle



	cm	↑ cm	fits to	€
84965	13 x 13,0	2,5	84937, 84936	
84966	17 x 17,0	2,5	84558, 84559	
84967	18 x 16,5	2,5	84584, 84583	
84968	18 x 11,0	2,5	84556, 84555	

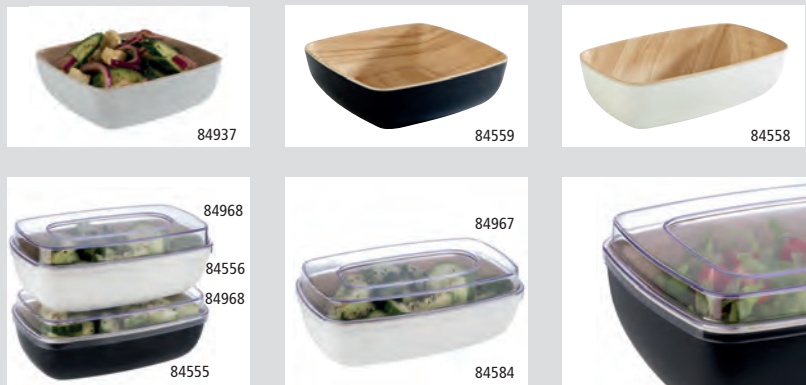

stapelbar / stackable



**Deckel „FLOAT“ mit Löffelaussparung**  
cover, with notched for spoons  
tapa, con espacio para la cuchara  
couvre-cle, avec encoche pour la louche



	cm	↑ cm	fits to	
83920	Ø 20,5	1,3	83908, 83909	rund
83921	19 x 19	1,3	83916, 83917	eckig
83922	25 x 25	1,3	83918, 83919	eckig



**Deckel „PURE“ mit Löffelaussparung**  
cover with notched for spoons  
tapa con espacio para la cuchara  
couvre-cle avec encoche pour la louche



	cm	↑ cm	fits to bowls
83600	19 x 19	1,5	84410, 84417, 84422, 83409, 83572, 84468, 83573, 84429, 84244
83601	25 x 25	1,5	84408, 84418, 84423, 83469, 83574, 83575, 83408, 84430, 84245, 84561, 84562
83602	32 x 32	1,5	84425, 84427

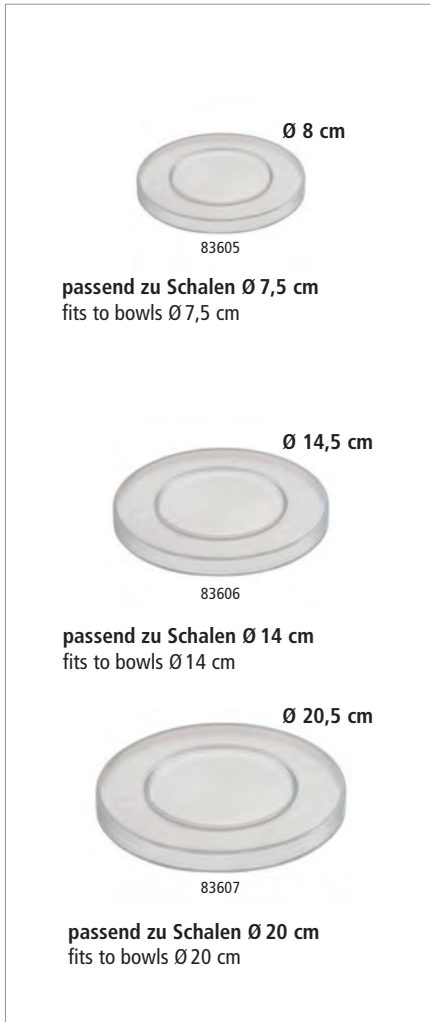

**Deckel „CASUAL“, 5er Set**  
cover, 5 pcs. set  
tapa, set de 5  
couvre-cle, set de 5



**Hygienischer Schutz für Ihre Speisen**

- dichtschießend
- schwappsicherer Transport
- BPA-frei

protection for your food

- tightly closing
- slosh-proof transport
- bpa-free

protección de alimentos

- con cierre hermético
- transporte sin salpicaduras
- libre de BPA

protection des aliments

- fermeture hermétique
- transport sans éclaboussures
- sans BPA

	Ø cm	↑ cm	VE	fits to
83605	8,0	0,5	5	11866, 83881, 15400, 15408, 15416, 15461, 15462, 15467, 15468, 40655, 40656
83606	14,5	0,5	5	11865, 83700, 83701, 84990, 85104, 85105, 85107
83607	20,5	0,5	5	83704, 83705, 15105, 15230, 15404, 15412, 15420, 85003, 85005, 85006, 85008

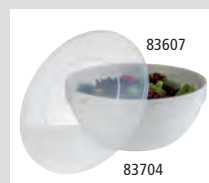

stapelbar  
stackable



**Frischhaltedeckel**

airtight cover  
tapa hermética  
couvercle hermétique



mit Silikondichtung, für luftdichtes Verschließen, Lebensmittel bleiben lange frisch  
with silicone sealing ring, bowls closed airtight, to keep food fresh for a long time  
junta de silicona para cerrar herméticamente y mantener los alimentos frescos más tiempo  
joint de silicone pour fermeture hermétique et meilleure conservation des aliments

	Ø cm	fits to
10890	14	11865, 83700, 83701
10887	23	11875, 11846, 11848, 83702, 83703



zwei Öffnungspositionen des Deckels  
two opening positions of the lid

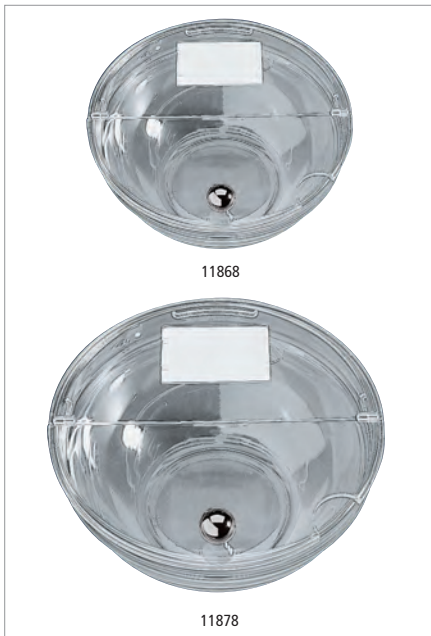

**Schutzdeckel mit Löffelaussparung**

cover  
tapa  
couvercle



glasklar, klappbar, mit 10 Beschriftungsschildern  
transparent, with 10 cards for inscription  
plástico transparente, con 10 etiquetas para inscripción  
plastique transparent, avec 10 étiquettes pour inscription

	Ø cm	
11868	14,5	mit verchromtem Griff / chrome plated handle botón cromado / bouton chromé
11878	23,5	mit verchromtem Griff / chrome plated handle botón cromado / bouton chromé

Schilder, 10er Set / signs, 10 pcs. set / set de 10 cartelitos / set de 10 étiquettes

	fits to
12879	11867, 11868
11879	11877, 11878



**Deckel klappbar mit Löffelaussparung**

cover hinged  
tapa con bisagra  
couvercle avec charnière



glasklar, mit Designer-Griff, verchromt, ohne Beschriftungsschild  
clear, with designer handle, chrome plated, without card for inscription  
transparente, con pomo de diseño cromado, sin tarjetas para inscripción  
transparent, avec bouton chromé de design, sans étiquette pour inscription

	Ø cm	fits to
10889	23,5	11817, 11818, 11845, 11847, 11849



**Schale**

bowl  
cuenco  
bol



	Ø cm	↑ cm	ltr.	pcs
11859	6,0	2,5	0,05	36
11866	7,5	3,5	0,09	36
11865	14,0	6,5	0,50	6
11875	23,0	10,5	2,50	6

**Kühlakku**

cooler  
acumulador de frío  
accumulateur de froid



gefüllt mit Kühlflüssigkeit, nicht giftig, einfach im Gefrierfach einfrieren,  
unbegrenzt wiederverwendbar

freeze it in freezer, non toxic, filled with freezer-liquid, boundless reusable  
se enfría en el congelador, no tóxico, se puede reutilizar sin límite

liquide eutectique qui accumule froid une fois dans le congélateur,  
non toxique, réutilisable sans limites

	Ø cm	↑ cm	Farbe / Colour
10777	15	2,5	
10781	10,5	2,5	
10661	10,5	2,0	
10752	10,5	2,0	

**Kühlakku**

cooler  
acumulador de frío  
accumulateur de froid



gefüllt mit Kühlflüssigkeit, nicht giftig, einfach im Gefrierfach einfrieren,  
unbegrenzt wiederverwendbar

freeze it in freezer, non toxic, filled with freezer-liquid, boundless reusable  
se enfría en el congelador, no tóxico, se puede reutilizar sin límite

liquide eutectique qui accumule froid une fois dans le congélateur, non toxique,  
réutilisable sans limites

	cm	↑ cm	Farbe / Colour	
10782	41 x 21	2,5		
10791	25 x 19	2,5		
11101	16 x 7,5	2,0		4er Set / 4 pieces set / set de 4 / set de 4

**Aufsteller „ACHTUNG RUTSCHGEFAHR“**

stand  
letrero  
panneau



	cm	↑ cm	Farbe / Colour
71421	30 x 63	63	





NEW

# Trinkflasche



**Trinkflasche**  
drinking bottle  
cantimplora  
gourde

EDELSTAHL  
STAINLESS  
INOX  
18/8

HOLZ  
WOOD

die doppelwandige Vakuumflasche aus Edelstahl hält Heißes 12 Stunden heiß und Kaltes 24 Stunden kalt, 100% auslaufsicher

the double-walled stainless steel vacuum bottle keeps hot drinks hot for 12 hours and cold drinks cold for 24 hours, 100% leak proof

la cantimplora al vacío de acero inoxidable de doble pared mantiene las bebidas calientes durante 12 horas y las frías durante 24 horas, 100% transporte sin salpicaduras

la gourde à vide en acier inoxydable à double paroi permet de conserver les boissons chaudes pendant 12 heures et les boissons froides pendant 24 heures, 100% transport sans éclaboussures

	Ø cm	↑ cm	ltr.
66905	7,5	24,5	0,5



**Trinkflasche**  
drinking bottle  
cantimplora  
gourde

EDELSTAHL  
STAINLESS  
INOX  
18/8

HOLZ  
WOOD

die doppelwandige Vakuumflasche aus Edelstahl hält Heißes 12 Stunden heiß und Kaltes 24 Stunden kalt, 100% auslaufsicher

the double-walled stainless steel vacuum bottle keeps hot drinks hot for 12 hours and cold drinks cold for 24 hours, 100% leak proof

la cantimplora al vacío de acero inoxidable de doble pared mantiene las bebidas calientes durante 12 horas y las frías durante 24 horas, 100% transporte sin salpicaduras

la gourde à vide en acier inoxydable à double paroi permet de conserver les boissons chaudes pendant 12 heures et les boissons froides pendant 24 heures, 100% transport sans éclaboussures

	Ø cm	↑ cm	ltr.
66906	7,5	29,5	0,75



...immer dabei



mit Schraubverschluss  
with screw cap

inkl. Ersatzdichtung  
incl. spare gasket

500 ml

750 ml



### Lunchbox „M“

lunchbox  
fiambrella  
boîte à lunch



**Edelstahlbox mit Silikondichtung inkl. Trennsteg, auslaufsicher**

stainless steel box with silicone seal incl. divider, leak-proof

caja de acero inoxidable con junta de silicona y divisor extraíble, transporte sin salpicaduras

boîte en acier inox avec joint en silicone et diviseur amovible, transport sans éclaboussures

	cm	↑ cm	ltr.
66900	18,5 x 13,5	6,5	0,8



### Lunchbox „L“

lunchbox  
fiambrella  
boîte à lunch



**Edelstahlbox mit Silikondichtung inkl. Trennsteg, auslaufsicher**

stainless steel box with silicone seal incl. divider, leak-proof

caja de acero inoxidable con junta de silicona y divisor extraíble, transporte sin salpicaduras

boîte en acier inox avec joint en silicone et diviseur amovible, transport sans éclaboussures

	cm	↑ cm	ltr
66901	20,5 x 14,5	6,5	1,1



### Lunchbox „XL“

lunchbox  
fiambrella  
boîte à lunch



**Edelstahlbox mit Silikondichtung inkl. Trennsteg, auslaufsicher**

stainless steel box with silicone seal incl. divider, leak-proof

caja de acero inoxidable con junta de silicona y divisor extraíble, transporte sin salpicaduras

boîte en acier inox avec joint en silicone et diviseur amovible, transport sans éclaboussures

	cm	↑ cm	ltr
66902	22,5 x 16,5	6,5	1,4



mit zwei Verschlüssen  
with 2 clasps

66900

0,8 ltr.



66901

1,1 ltr.



66902

1,4 ltr.



herausnehmbarer Trennsteg  
removable divider

auslaufsicher | leak-proof





# Laserlogo Individual

perfekte Lasergravuren  
perfectly Laser engravings  
grabado perfecto por láser  
marcage laser parfait



## Unverwechselbar - Einzigartig - Imagefördernd Ihre individuelle Lasergravur von APS

Wir bieten Ihnen die Möglichkeit, unsere Produkte mit Ihrem individuellen Logo per Laser zu gravieren - einzigartig, unverwechselbar und bereits ab 10 Stück je Artikel. Die perfekte Beschriftung durch modernste Lasertechnologie ist spülmaschinenfest und somit dauerhaft auf allen Edelstahl- und Naturschieferprodukten, sowie auf versilberten und verchromten Metall-Artikeln umsetzbar. Machen Sie aus Ihren Gastronorm-Behältern Ihre ganz persönlichen Unikate und werten Sie Ihre Servierartikel mit Ihrem eigenen Logo auf.

- geringe Mindestbestellmenge von nur 10 Stück
- kurze Lieferzeiten
- Logos bis zu einer Fläche von max. 10 x 10 cm realisierbar

## Distinct - Unique - Image enhancing Your individualised laser engraving by APS

We offer you the option of having your personalised logo engraved on our products - inimitable, unique, and available for delivery from only 10 pieces per product. The perfect inscription by use of the newest technology is dishwasher-safe and thus can be permanently applied to products made of stainless steel and natural slate, as well as silver-coated and chromed metal articles. Turn your gastronorm container into your individual, one of a kind article and enhance your serving items with your own logo.

- minimum order quantity of only 10 pieces
- swift delivery
- feasible logos are those with a maximum size of 10 x 10 cm

## Único, personalizado, promotor de imagen Grabado laser por APS

Podemos grabar su logo y así personalizar los productos APS a partir de mínimo 10 unidades por referencia.

Gracias a la novedosa tecnología de grabado por láser, la inscripción es perfecta y resistente al lavavajillas. Se puede aplicar a los artículos en acero inoxidable, pizarra natural, metal cromado y plateado.

- Cantidad mínima de solamente 10 unidades
- Realización rápida
- Tamaño de logos hasta máximo 10 x 10 cm

## Unique, original, porteur d'image Marcage laser par APS

Nous pouvons graver votre logo et ainsi personnaliser les produits APS à partir de 10 pièces par référence.

Grâce à une technologie d'avant-garde de marcage par laser, l'inscription est parfaitement reproduite et résistante au lave-vaisselle. Ce type de marcage peut s'appliquer sur l'acier inoxydable, sur l'ardoise naturelle, sur le métal chromé ou argenté.

- Quantité minimum de seulement 10 unités
- Fabrication rapide
- Taille du logo jusque 10 x 10 cm

# Icon-Index / Material-Index

 <b>neuer Artikel</b> new item	 <b>spülmaschinengeeignet</b> dishwasher-proof	 <b>für Induktionsplatten</b> for induction use	 <b>max. 70°C</b>
 <b>MF - Melamin</b>	 <b>nicht spülmaschinengeeignet</b> not dishwasher-proof	 <b>kühlbar</b> for cooling	
 <b>Made in Germany</b>	 <b>abwaschbar / wasserfest</b> water-proof	 <b>bruchsicher</b> shatter-proof	
 <b>GN-Größen</b> GN norm	 <b>mikrowellengeeignet</b> microwave-proof	 <b>Eigenmontage</b> self assembly	
 <b>stapelbar</b> stackable	 <b>nicht mikrowellengeeignet</b> not microwave-proof	 <b>für Lebensmittelkontakt</b> food safe	
 <b>Antirutsch-Füßchen</b> non-slip feet	 <b>keine direkte Hitze</b> not direct heat	 <b>recyclbar</b> recyclable	
 <b>wasserfest</b> water-resistant	 <b>nicht für Backofen</b> not for baking oven	 <b>BPA frei</b> BPA free	

## APS - BSCI-Mitglied

APS engagiert sich für die Verbesserung von Arbeitsbedingungen. Wir sind Partner der europäischen Organisation BSCI. Die "Business Social Compliance Initiative" (BSCI) ist eine Initiative von Unternehmen zur Verbesserung der Arbeitsbedingungen in der globalen Versorgungskette.



## APS is a member of BSCI

APS is committed to the improvement of working conditions. We are a partner of the European organization BSCI. The "Business Social Compliance Initiative" is an initiative of enterprises to improve working conditions in the global supply chain.

## APS Melamin - Garantierte Qualität

APS-Melaminprodukte entsprechen den Richtlinien (EG) 1935/2004 und (EU) 10/2011 der Europäischen Kommission. Diese enthalten Bestimmungen für Materialien aus Kunststoffen, welche mit Lebensmitteln in Berührung kommen. Wir arbeiten sehr eng mit den Zertifizierungsinstitutionen Intertek und TÜV zusammen und können somit die Lebensmittelsicherheit (LFGB Regulation) der APS-Melaminartikel garantieren.

## APS Melamine - Guaranteed quality

APS melamine products comply with directives (EG) 1935/2004 and (EU) 10/2011 of the European Commission. This contain provisions for plastic materials which come into contact with foodstuffs. We work very closely together with the certification institutions Intertek and TÜV and are therefore able to guarantee the compatibility with foodstuffs (German LFGB regulation) of APS melamine.

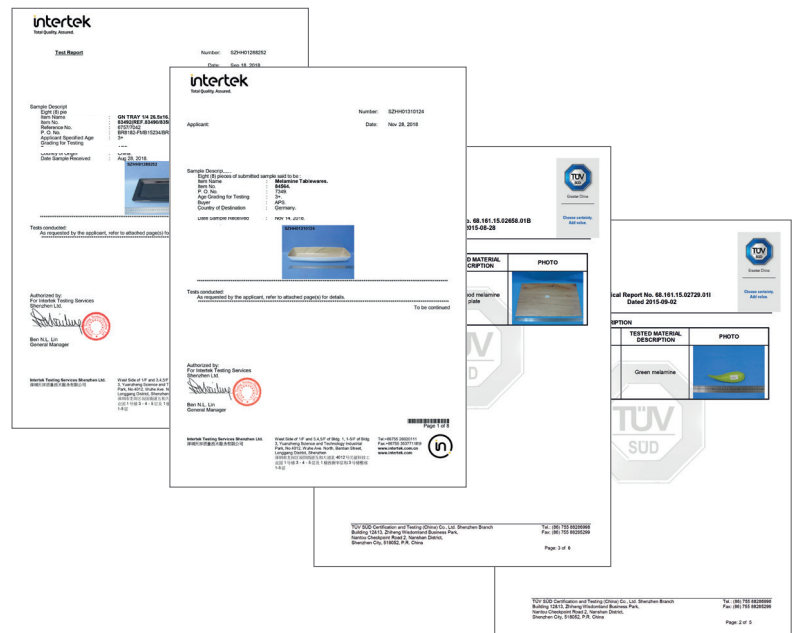



**Edelstahl 18/10 / Stainless steel 18/10**

Werkstoff 1.4301; rostfrei; langlebig; gute isolierende Eigenschaften; absolut hygienisch und nicht toxisch; recyclebar; nicht resistent gegen dauerhaften Kontakt mit Chloriden und Säuren (z. B. Kochsalz und Fruchtsäuren); sterilisierbar; Oberfläche lässt sich vielfältig polieren; nicht magnetisch; Gebrauchstemperatur bis ca. 400 °C

Pflege: pflegeleicht; maschinell oder per Hand mit milden Spülmitteln; möglichst keine Stahlwolle u. ä. verwenden; nach Erhitzung Schockabkühlung vermeiden

**Edelstahl (unspezif.) / Stainless steel (unspecific)**

niedrig nickelhaltige Edelstähle wie 14/4; nicht magnetisch; geringere allgemeine Resistenz als Edelstahl 18/10; Pflege: s. Edelstahl 18/10

**Edelstahl 18/0 / Stainless steel 18/0**

Werkstoff 1.4016; rostfrei; langlebig bei entsprechender Pflege; absolut hygienisch und nicht toxisch; gut härtbar, daher idealer Stahl für Tafelmesser, Tablett, Schneidwerkzeuge u. ä.; lässt sich hochglanzpolieren; für Nickelallergiker geeignet; magnetisch; nicht so chemikalienresistent wie Edelstahl 18/10; Gebrauchstemperatur bis ca. 400 °C

Pflege: maschinell oder per Hand mit milden Spülmitteln; Ablagerungen von Kalk und Reinigerresten nach dem Spülen unbedingt entfernen; niemals mit Stahlwolle reinigen

**Eisen / Iron**

nicht rostfrei; charakteristische, strukturierte Oberfläche mit unterschiedlichen Schattierungen; durch wiederholten Schmiedevorgang ist das Material stark verdichtet und sehr hart; langlebig bei entsprechender Pflege, Pflege: vor erstem Einsatz mit Öl und Kartoffelschalen „einbraten“; später nach jeder Reinigung einfetten; stets trocken lagern

**Gusseisen / Cast Iron**

langlebig bei entsprechender Pflege; geeignet für alle Herdarten (inkl. Induktion); speichert lange Wärme und gibt sie gleichmäßig ab; absolut hygienisch bei unbeschädigter Oberfläche; relativ schweres Material; Überhitzung fast nicht möglich; nicht schlagfest; magnetisch, Pflege: nach Gebrauch sofort mit heißem Wasser reinigen; bei Fleckenbildung mit Essig nachreinigen; niemals mit Stahlwolle reinigen; milde Spülmittel verwenden; stets trocken lagern

**Versilberter Stahl / Silver plated steel**

Edelmetallüberzug; nicht völlig säurefest; nicht über längere Zeit Sonnenlicht aussetzen

Pflege: niemals scheuernde Hilfsmittel verwenden; nur mit weichem Lappen und Spezialmitteln reinigen; keine Spülmaschinenreinigung!

**Verchromter Stahl / Chrome plated steel**

nichtedles Metall mit hartem Chromüberzug; nicht säurefest; nach Beschädigung der Chromschicht kein Schutz gegen Umwelteinflüsse

Pflege: niemals scheuernde Hilfsmittel verwenden; nur mit weichem Lappen

**Aluminium**

sehr leichtes Material; sehr gute elektrische und thermische Leitfähigkeit; korrosionsbeständig; nicht spülmaschinengeeignet; Gebrauchstemperatur bis ca. +500 °C

**Porzellan**

spülmaschinengeeignet; hitzebeständig bis ca. +220 °C

**GFK – Glasfaserverstärkter Kunststoff**

starr; nahezu unzerbrechlich; spülmaschinengeeignet; Gebrauchstemperatur bis ca. +100 °C

**ABS – Acrylnitril-Butadien-Styrol**

sehr gute Oberflächenhärte; temperaturwechselfest; spülmaschinengeeignet; Gebrauchstemperatur bis ca. +100 °C

**ACRYL – künstliches Harz**

farblos; glasartig; durchsichtig; nicht splittend; chemisch modifiziert als Plexiglas®; wichtiger Pflegehinweis: nur handelsübliche Acrylspezialreiniger oder milde alkohol- und ammoniakfreie Reinigungsmittel verwenden; nicht spülmaschinengeeignet; Gebrauchstemperatur ca. -40 °C bis ca. +50 °C

**EVA - Ethylenvinylacetat**

weich elastisch; glänzend; abwaschbar / wasserfest; Gebrauchstemperatur bis ca. +60 °C

**MF - Melamin**

sehr hart; stoß- und kratzfest; hygienisch; säurebeständig; spülmaschinengeeignet; Gebrauchstemp. ca. -30 °C bis +70 °C

**MS - Kunststoff**

farblos; glasartig; durchsichtig; nicht spülmaschinengeeignet; Gebrauchstemperatur ca. 0 °C bis ca. +70 °C

**PA - Polyamid**

starr; bruch- und schlagfest; mattglänzend; spülmaschinengeeignet; Gebrauchstemperatur bis ca. +220 °C

**PC - Polycarbonat**

starr; nahezu unzerbrechlich; sehr stabil; formbeständig in kochendem Wasser; spülmaschinengeeignet; mikrowellengeeignet; Gebrauchstemperatur ca. -30 °C bis ca. +100 °C

**PE - Polyethylen****HDPE – hochdichtes Polyethylen**

hart elastisch; unzerbrechlich; ausreichend formbeständig in heißem Wasser; glänzend; spülmaschinengeeignet; Gebrauchstemperatur ca. -40 °C bis ca. +120 °C

**NDPE – niederdichtes Polyethylen**

weich elastisch; unzerbrechlich; kurzzeitig formbeständig in heißem Wasser; nicht glänzend; spülmaschinengeeignet; Gebrauchstemperatur ca. -40 °C bis ca. +95 °C

**PP - Polypropylen**

hart elastisch; unzerbrechlich; umweltschonend recyclebar; spülmaschinengeeignet; mikrowellengeeignet; Gebrauchstemperatur ca. -30 °C bis ca. +75 °C

**PS - Polystyrol**

starr; kratzfest; formbeständig in kochendem Wasser; nicht spülmaschinengeeignet; Gebrauchstemperatur bis ca. +70 °C

**PVC - Polyvinylchlorid**

säurebeständig; schwer entflammbar; nicht spülmaschinengeeignet; Gebrauchstemperatur ca. -50 °C bis ca. +60 °C

**SAN - Styrol-Acrylnitril**

gute Oberflächenhärte; temperaturwechselfest; spülmaschinengeeignet; Gebrauchstemperatur bis ca. +100 °C

**Silikon**

hohe thermische Beständigkeit; gute Kälteflexibilität; spülmaschinengeeignet; Gebrauchstemp. ca. -70 °C bis ca. +180 °C

**Tritan®**

starr; unzerbrechlich; absolut formbeständig; sehr hohe Chemikalienbeständigkeit; spülmaschinenfest; Gebrauchstemperatur ca. -30 °C bis ca. +95 °C; nicht mikrowellengeeignet

**Schiefer®**

Naturschiefer versiegelt; lebensmittelecht; nicht spülmaschinengeeignet;

**Beton®**

Werkstoff Beton, coole Optik; nicht spülmaschinengeeignet; handgefertigt

**Tetron**

Maschinenwaschbar bis 30 Grad, 65% Polyester, 35% Viskose

# Index

Artikel-Nr.	Prüfziffer	Seite	00505	1	144, 468	00650	8	395	00869	4	134, 279	01332	2	116	09104	7	36
00011	7	343	00506	8	143, 467	00652	2	120	00870	0	134, 279	01335	3	116	09200	6	37
00012	4	343	00507	5	143, 467	00662	1	481	00871	7	134, 279	01336	0	115	09202	0	37
00013	1	347	00508	2	144, 468	00664	5	481	00872	4	134, 279	01338	4	116	09204	4	37
00014	8	154, 284, 337	00510	5	143, 467	00666	9	481	00873	1	134, 279	01348	3	116	09923	4	242
00016	2	336	00511	2	143, 467	00668	3	481	00874	8	134, 279	01349	0	116	09924	1	242
00017	9	347	00515	0	143, 467	00670	6	481	00875	5	134, 279	01358	2	116	<b>1</b>		
00018	6	339	00521	1	145, 469	00671	3	482	00876	2	134, 279	01415	2	112	10316	0	303, 460
00019	3	335	00522	8	145, 469	00672	0	482	00877	9	134, 279	01416	9	112	10318	4	462
00020	9	335	00524	2	144, 468	00673	7	482	00878	6	139, 280	01420	6	112	10319	1	462
00021	6	344	00525	9	144, 468	00677	5	268	00879	3	132	01699	6	118, 305	10320	7	462
00022	3	341	00526	6	144, 468	00685	0	490	00880	9	132	01709	2	117	10321	4	462
00023	0	344	00528	0	145, 469	00686	7	490	00881	6	132	01710	8	117	10322	1	461
00024	7	336	00529	7	145, 469	00687	4	490	00882	3	132	01711	5	117	10323	8	461
00025	4	335	00530	3	145, 469	00688	1	490	00883	0	95, 142	01712	2	117	10325	2	461
00026	1	335	00531	0	145, 469	00691	1	268	00884	7	95, 142	01738	2	116	10326	9	461
00027	8	336	00532	7	145, 469	00692	8	268	00885	4	95, 142	01748	1	116	10327	6	461
00028	5	335	00533	4	145, 469	00693	5	268	00886	1	95, 142	02038	2	338	10328	3	461
00029	2	336	00535	8	145, 469	00694	2	511	00887	8	134, 279	02039	9	338	10329	9	461
00030	8	344	00536	5	145, 469	00695	9	511	00897	7	133, 281, 468	02310	9	119	10330	6	461
00031	5	338	00537	2	145, 469	00696	6	511	00898	4	133, 281, 468	02311	6	119	10331	3	461
00032	2	304	00538	9	145, 469	00697	3	511	00899	1	133, 281, 468	02312	3	119	10332	0	461
00033	9	303, 463	00540	2	145, 469	00700	0	345	00905	9	135, 276	03020	6	312	10333	4	460
00036	0	344	00541	9	145, 469	00711	6	482	00906	6	135, 276	03025	1	312	10335	1	460
00037	7	342	00542	6	145, 469	00712	3	482	00907	3	139, 276	03038	1	312	10336	8	460
00040	7	509	00543	3	145, 469	00713	0	482	00908	0	139, 276	03039	8	312	10400	6	40
00042	1	509	00547	1	143, 467	00714	7	482	00910	3	100	03098	5	312	10403	7	39
00046	9	147, 329	00548	8	143, 467	00715	4	482	00911	0	23, 100	03099	2	312	10404	4	39
00048	3	473	00549	5	143, 467	00716	1	482	00912	7	100	03622	2	109, 253	10405	1	39
00050	6	473	00552	5	145, 469	00721	5	482	00914	1	100	03623	9	109, 253	10409	9	39, 452
00052	0	472	00553	2	145, 469	00722	2	482	00937	0	130, 277	03824	0	114	10410	5	39
00054	4	472	00554	9	145, 469	00723	9	482	00941	7	129, 278	04001	4	310	10411	2	39
00056	8	472	00555	6	145, 469	00730	7	482	00942	4	129, 278	04002	1	310	10415	0	41, 452
00058	2	332, 470	00560	0	471	00740	6	503	00945	5	129, 278	04003	8	310	10416	7	41
00060	5	345	00561	7	471	00744	4	503	00951	6	95, 142	04004	5	310	10417	4	41
00063	6	304	00562	4	471	00745	1	503	00952	3	95, 142	04005	2	311	10418	1	41
00064	3	119	00563	1	471	00746	8	503	00953	0	94	04006	9	311	10420	4	42
00065	0	120	00564	8	471	00747	5	503	00954	7	94	04008	3	310	10421	1	42, 44
00067	4	70, 119	00565	5	471	00765	9	302, 458	00955	4	95, 142	04010	6	313	10422	8	42, 43
00069	8	74, 348	00566	2	471	00766	6	301, 458	00956	1	95, 142	04011	3	313	10423	5	42, 44
00070	4	343	00567	9	471	00768	0	301, 302, 458	00957	8	95, 142	04015	1	313	10424	2	42, 43, 44, 45
00071	1	346	00568	6	472	00771	0	506	00958	5	86	04016	8	313	10425	9	44
00072	2	345	00570	9	474	00772	7	292, 505	00959	2	94	04017	5	313	10426	6	43, 45
00075	9	115	00572	3	347	00773	4	291	00960	8	91, 131	04020	5	310	10427	3	44, 45
00076	6	343	00574	7	475	00774	1	291	00966	0	129	04021	2	310	10428	0	43, 45
00078	0	345	00576	1	474	00775	8	291	00968	4	130	04035	9	311	10430	3	43
00079	7	345	00578	5	474	00776	5	291	00969	1	130	04036	6	311	10435	8	45
00081	0	114	00580	8	475	00777	2	291	00971	4	130, 277, 290	04037	3	311	10440	2	50
00082	7	114	00581	5	332, 470	00778	9	291	00972	1	121	04446	3	333	10500	3	426
00084	1	114	00582	2	472	00779	6	292, 505	00973	8	24, 25, 128	06401	0	119, 531	10501	0	42, 43, 44, 45, 426
00085	8	115	00583	9	472	00780	2	510	00975	2	130	06501	7	530	10502	7	426
00087	2	114	00584	6	472	00781	9	291	00978	3	121	06503	1	120	10503	4	426
00090	2	473	00585	3	472	00782	6	291	00984	4	131, 277	06504	8	530	10504	1	426
00091	9	473	00586	0	474	00783	3	291	00986	8	129, 277	06506	2	530	10505	8	41, 427
00092	6	507	00587	7	484	00785	7	505	00987	5	129, 277	06510	9	120, 135, 253, 530	10506	5	268
00093	3	507	00588	4	484	00805	2	140	00988	2	129, 278	06512	3	77, 135, 140, 253, 530	10509	6	427
00094	0	507	00589	1	484	00806	9	95, 132, 140, 142	00989	9	91, 131	06515	4	530	10510	2	427
00098	8	507	00590	7	484	00807	6	140	00990	5	24, 25, 128	06517	8	530	10511	9	427
00099	5	507	00591	4	484	00808	3	135, 276	00991	2	24, 25, 128	06519	2	140, 148, 204, 213, 328, 529	10512	6	427
00106	0	509	00592	1	485	00809	0	137	00992	9	128	06520	8	77, 135, 140, 148, 204, 213, 328, 529	10513	3	426
00110	7	507	00593	8	485	00810	6	133, 281	00993	6	24, 25, 128	06521	5	140, 148, 204, 213, 328, 529	10514	0	426
00113	8	507	00594	5	485	00811	3	133, 281	00994	3	128, 278	06525	3	149, 528	10515	7	426
00292	0	336	00595	2	485	00812	0	133, 281	00995	0	128, 278	06701	1	119, 531	10516	4	426
00311	8	338	00596	9	485	00813	7	133, 281	00996	7	128, 278	08201	4	115	10517	1	426
00381	1	114	00597	6	485	00814	4	133, 281, 468	00997	4	131	09000	2	35	10525	6	427
00382	8	114	00598	3	485	00815	1	140	00998	1	130	09001	9	35	10526	3	427
00383	5	114	00599	0	495	00816	8	140	00999	8	130	09002	6	35	10527	0	427
00384	2	114	00600	3	478	00817	5	137	01000	0	121, 130, 138	09003	3	35	10528	7	427
00385	9	114	00601	0	479	00818	2	135, 147, 330									

10576	8	428	10865	3	49	11444	9	104	11762	4	156	11998	7	152, 335	14985	4	21
10577	5	428	10867	7	49	11446	3	104	11763	1	156	11999	4	153, 335, 411	14987	8	21, 66
10578	2	428	10870	7	20, 51	11449	4	104	11765	5	156	12000	0	110	14990	8	18
10579	9	428	10871	4	20, 51	11451	7	105	11767	9	155	12008	2	526	14995	3	21
10608	6	47	10872	1	20, 51	11455	5	105	11768	6	155	12010	5	526	15100	0	167
10661	1	19, 32, 33, 535	10873	8	20, 51	11456	2	105	11770	9	155	12065	5	111	15101	7	167
10663	5	51	10887	5	19, 534	11466	1	105	11771	6	155	12100	0	110	15102	4	167
10668	0	67	10889	9	534	11467	8	105	11775	4	93	12225	3	389	15105	5	168
10690	1	56	10890	5	19, 534	11495	1	80, 83	11776	1	93	12232	1	390	15106	2	168
10691	8	56	10907	0	52	11496	8	80	11778	5	157	12233	8	386	15108	6	168
10700	7	46	10910	0	55	11497	5	80	11780	8	157	12235	2	389	15110	9	167
10701	4	47	10911	7	55	11498	2	80	11781	5	157	12236	9	386	15111	6	167
10703	8	47	10912	4	55	11499	9	80	11795	2	81	12243	7	392	15112	3	167
10704	5	47	10913	1	54	11503	3	30	11805	8	65	12244	4	392	15113	0	167
10707	6	47	10914	8	54	11505	7	30	11807	2	65	12245	1	386	15114	7	167
10708	3	47	10915	5	54	11510	1	28	11808	9	64, 65	12249	9	385, 386	15115	4	167
10709	0	47	10916	2	54	11512	5	29	11810	2	33	12270	3	78, 387	15116	1	166
10710	6	47	10917	9	54	11514	9	28	11811	9	32, 33	12271	0	78, 387	15117	8	166
10711	3	47	10921	6	55	11516	3	29	11812	6	32	12272	7	78, 387	15200	7	169
10712	0	47	10922	3	55	11522	4	84	11813	3	32	12285	7	393	15201	4	169
10713	7	47	10923	0	55	11523	1	83, 84	11815	7	33	12287	1	53, 392, 393	15204	5	169
10714	4	47	10924	7	55	11524	8	83	11816	4	32, 33	12290	1	394	15205	2	169
10715	1	47	10990	2	63, 461	11526	2	83	11817	1	32	12291	8	383, 384, 393	15215	1	169
10716	8	47	10991	9	63, 461	11527	9	83	11818	8	32	12292	5	394	15216	8	169
10717	5	47	10992	6	63, 461	11528	6	84	11833	1	66	12294	9	394	15217	5	169
10718	2	39, 41	10993	3	63	11529	3	84	11834	8	66	12295	6	78, 379, 380, 382, 383, 384, 387, 393	15218	2	169
10720	5	46	10994	0	63	11533	0	31	11840	9	64	12296	3	382, 393	15219	9	168
10721	2	56	11000	0	110	11538	5	31	11841	6	64	12299	4	393	15220	5	168
10722	9	56	11008	3	26, 30, 363, 526	11540	8	26	11845	4	34	12299	4	393	15225	0	166
10738	0	57	11010	6	26, 28, 30, 195, 211, 363, 526	11541	5	26	11846	1	32, 33	12300	7	385	15226	7	166
10739	7	57	11013	7	526	11542	2	27	11847	8	33	12310	6	392	15227	4	166
10741	0	57	11016	8	526	11543	9	27	11848	5	32, 33	12312	9	378	15228	1	166
10742	7	57	11018	2	17, 363, 526	11553	8	364	11849	2	33	12322	9	378	15230	4	169
10748	9	58	11020	5	111	11555	2	364	11859	1	534	12323	6	378	15231	1	169
10749	6	58	11021	2	195, 211, 363, 525	11556	9	102	11865	2	80, 534	12324	3	379	15232	8	169
10750	2	51	11022	9	363, 371, 525	11557	6	86, 141	11866	9	534	12325	0	379	15233	5	169
10752	6	58, 535	11026	7	363, 525	11558	3	86, 141	11868	3	32, 33, 80, 534	12329	8	388	15234	2	168
10756	4	52	11027	4	195, 352, 362, 363, 371, 525	11562	0	102	11875	1	34, 79, 534	12330	4	388	15235	9	168
10757	1	52	11028	1	363, 525	11563	7	93	11878	2	32, 33, 34, 79, 534	12335	9	388	15236	2	176, 374
10758	8	52	11032	0	110	11572	9	102	11879	9	347, 534	12336	6	388	15236	6	388
10759	5	52	11038	0	110	11573	6	102	11881	2	515	12337	3	388	15322	9	374
10760	1	46	11040	0	111	11574	3	93	11884	3	70	12338	0	388	15323	3	374
10761	8	58	11041	0	113, 191, 195, 524	11575	0	93	11888	3	70	12350	2	385	15324	0	176, 374
10762	5	58	11042	7	113, 191, 211, 352, 371, 524	11576	7	93	11885	0	70	12352	6	381	15325	7	374
10764	9	59	11043	4	113, 191, 524	11579	8	462	11887	4	101	12353	3	381	15326	4	375
10766	3	59	11044	1	77, 113, 191, 371, 524	11590	3	30	11888	1	101	12354	0	381	15331	8	375
10769	4	59	11048	0	110	11595	8	79, 84	11889	8	101	12360	1	389	15332	5	375
10770	0	59	11051	9	529	11596	5	79	11891	1	101	12366	3	381, 384	15333	9	375
10771	7	60	11052	6	529	11597	2	79	11892	8	81	12370	0	381	15335	6	375
10772	4	60	11053	3	529	11598	9	79	11893	5	81	12371	7	381	15340	0	168, 171
10773	1	60	11054	0	529	11599	6	79	11901	7	390	12372	4	381	15341	7	168, 169, 171
10774	8	60	11055	7	531	11607	8	102	11910	9	390	12393	9	384	15342	4	168, 171
10775	5	60	11056	4	531	11608	5	153, 306	11911	6	390	12394	6	382	15343	1	171
10776	2	60	11057	0	111	11609	2	153, 306	11912	3	390	12396	0	383	15344	8	168, 169, 171
10777	9	19, 32, 33, 34, 47, 535	11058	6	529	11610	8	153, 306	11913	0	390	12397	7	381, 383	15345	5	167, 169
10778	6	67	11059	3	529	11612	2	307	11915	4	389	12398	4	383	15346	2	167, 169
10781	6	535	11060	0	110	11616	0	24	11916	1	389	12399	1	383	15347	9	167, 169
10782	3	535	11061	0	110	11617	7	24	11917	8	389	12403	5	384	15348	6	166, 168
10788	5	46	11062	7	22, 23	11620	7	22, 23	11921	5	337	12404	2	382	15350	9	527
10789	2	46	11063	4	22, 23	11621	4	22, 23	11922	2	337	12483	7	385	15351	6	527
10791	5	26, 27, 28, 30, 31, 35	11065	0	111	11622	1	22	11930	7	334	12484	4	385	15400	1	171
10792	2	56	11066	0	111	11623	8	22	11931	4	334	12879	8	347, 534	15401	8	171
10795	3	53	11100	0	30, 110	11625	2	309	11935	2	339	12940	5	14	15402	5	171
10796	0	53	11101	1	29, 31, 36, 37, 535	11626	9	22, 23	11936	9	339	12941	2	14	15403	2	171
10800	4	46	11110	3	110	11627	6	22, 23	11937	6	339	12990	0	448	15404	9	171
10801	1	47	11118	9	15	11628	3	22	11939	0	152, 339	13122	4	117	15405	6	171
10802	8	48	11119	6	15, 234	11629	0	22	11940	6	412	13377	8	509	15406	3	171
10803	5	47	11150	9	111	11638	2	154, 307	11945	1	409	13378	5	509	15407	0	171
10804	2	47	11155	4	111	11647	4	307	11946	8	409	13379	2	509	15408	7	171
10805	9	49	11160	8	112	11648	1	307	11947	5	409	13380	8	126, 282	15409	4	171
10806	6	49	11165	3	112	11649	8	154, 308	11948	2	150	13382	2	117	15410	0	171
10807	3	47	11195	0	113, 405	11650	4	309	11949	9	150	13385	3	117	15411	7	171
10808	0	47	11210	0	112	11651	1	309	11950	5	412	13622	9	117	15412	4	171
10809	7	47	11220	9	112	11671	9	53, 392	11951	2	150	13940	4	14	15413	1	171
10810	3	53	11244	5	392	11672	6	53, 392	11952	9	150	13941	1	14	15414	8	171
10812	7	47	11290	2	111	11675	7	386	11954	3	151, 410	13955	8	15	15415	5	171
10814	1	47	11295	7	112	11683	2	394	11955	0	151, 410	13960	2	15	15416	2	171
10825	7	52	11300	8	111	11700	6	25	11960	4	151, 410	13965	7	66	15417	9	171
10830	1	51	11302	2	113, 407	11701	3	25	11965	9	151, 410	13966	4	73	15418	6	171
10833	2	51	11305	3	113, 524	11702	0	25	11966	6	151, 359, 4						

15440	7	170	30065	1	413, 512	30422	2	372	36038	9	422	40222	5	360	40499	1	301, 458
15443	8	170	30066	8	413, 512	30423	9	372	36044	0	421	40223	2	359	40500	4	292
15444	5	170	30067	5	413, 512	30440	6	367	36045	7	420	40224	9	360	40501	1	292
15445	2	170	30068	2	413, 512	30441	3	367	36046	4	420	40225	6	359	40503	5	292
15448	3	170	30069	9	413, 512	30442	0	367	36047	1	420	40226	3	360	40504	2	136, 292
15449	0	170	30070	5	413, 512	30443	7	367	36048	8	422	40227	0	359	40505	9	292
15450	6	170	30071	2	413, 512	30444	4	367	36050	1	424	40228	7	360	40506	6	302, 459
15451	3	170	30075	0	413, 511	30445	1	367	36052	5	422, 424	40229	4	359	40507	3	292
15452	0	170	30076	7	413, 511	30446	8	367	36053	2	422	40230	0	360	40508	0	303, 460
15453	7	170	30077	4	413, 511	30447	5	367	36054	9	422	40240	9	360	40509	7	302, 459
15454	4	170	30078	1	413, 511	30450	5	367	36055	6	417	40242	3	360	40510	3	301, 363, 460
15455	1	170	30108	5	333, 470	30451	2	367	36056	3	422	40243	0	359	40511	0	300
15456	8	170	30110	8	333, 470	33206	5	73	36057	0	421	40244	7	360	40520	2	289
15457	5	170	30111	5	124, 466	33207	2	73	36062	4	424	40245	4	359	40521	9	289
15458	2	170	30112	2	124, 466	33208	9	89	36063	1	423	40246	1	360	40522	6	289
15460	5	170	30113	9	124, 466	33209	6	89	36066	2	417	40247	8	359	40524	0	289
15461	2	174	30114	6	125, 465	33210	2	86	36068	6	418	40248	5	360	40530	1	289
15462	9	174	30115	3	124, 466	33211	9	90	36069	3	418	40249	2	359	40531	8	289
15467	4	174	30116	0	124, 466	33212	6	90	36074	7	423	40250	8	360	40532	5	289
15468	1	174	30117	7	124, 466	33214	0	91	36075	4	425	40260	7	360	40534	9	289
15473	5	174	30118	4	125, 465	33215	7	90	36077	8	421	40262	1	360	40535	6	288
15474	2	174	30119	1	125, 465	33216	4	91	36087	7	421	40263	8	360	40536	3	289
15475	9	174	30120	7	125, 465	33217	1	91	36090	7	424	40264	5	360	40537	0	288
15477	3	174	30121	4	125, 243	33219	5	90	36092	1	416	40266	9	360	40538	7	287
15479	7	174	30123	8	124, 466	33220	1	90	36093	8	416	40268	3	360	40539	4	287
15483	4	174	30126	9	125, 466	33222	5	85	36095	2	61, 419	40270	6	360	40540	0	288
15485	8	174	30130	6	126, 282, 464	33225	6	90	36096	9	61, 419	40272	0	360	40541	7	288
15486	5	174	30131	3	126, 282, 464	33226	3	85	36099	0	424	40274	4	360	40544	8	290
15487	2	174	30132	0	126, 282, 464	33227	0	85	36100	3	61, 420	40276	8	360	40545	5	290
15491	9	174	30133	7	126, 282, 464	33228	7	85	36101	0	61, 420	40278	2	360	40546	2	288
15495	7	174	30148	1	124, 465, 470	33231	7	92	36102	7	456	40280	5	360	40547	9	289
15497	1	170	30149	8	124, 465, 470	33232	4	72, 102	36103	4	456	40290	4	16, 359	40548	6	288
15498	8	170	30200	6	372	33238	6	92	36111	9	61, 419	40291	1	16, 359	40549	3	285
15499	5	170	30205	1	369	33241	6	86	36112	6	61, 419	40292	8	16, 359	40550	9	285
15500	8	170	30206	8	369	33246	1	82, 326	36120	1	419	40293	5	16, 359	40551	6	285
15501	5	176	30207	5	373	33247	8	82, 326	36121	8	419	40294	2	16, 363	40552	3	285
15502	2	176	30208	2	373	33248	5	92	36233	8	332	40295	9	16, 362	40553	0	286
15503	9	100, 176	30210	5	372	33249	2	107	36323	6	332	40296	6	355	40554	7	286
15504	6	176, 206	30220	4	372	33250	8	107	38202	2	115	40297	3	355	40555	4	136, 286
15505	3	176, 206	30230	3	372	33251	5	107				40299	7	363	40556	1	136, 286
15506	0	78, 100, 176, 387	30240	2	372	33252	2	107	<b>4</b>			40300	0	299	40557	8	287
15507	7	176, 375	30250	1	372	33255	3	76, 109	40007	8	334, 365	40310	9	295	40558	5	287
15508	4	176, 375	30270	9	372	33256	0	76, 109	40009	2	334, 365	40311	6	295	40559	2	288
15509	1	176, 375	30276	1	374	33260	7	107	40010	8	334, 365	40312	3	295	40560	8	288
15513	8	109, 176	30277	8	374	33261	4	107	40011	5	334, 365	40313	0	295	40600	1	271
15514	5	109, 176	30279	2	366	33262	1	107	40012	2	334, 365	40320	8	295	40601	8	271
15515	5	167	30280	8	366	33269	0	107	40013	9	334, 365	40330	7	298	40602	5	271
15600	5	167	30281	5	366	33270	6	107	40110	5	114, 374	40331	4	298	40603	2	271
15601	2	167	30282	2	366	33271	3	107	40115	0	114, 374	40403	8	308	40604	9	274, 370
15603	6	167	30283	9	366	33272	0	108	40129	7	362	40404	5	308	40605	6	272
15604	3	167	30284	6	366	33273	7	108	40130	3	334, 365	40405	2	308	40606	3	272
15605	0	167	30285	3	366	33278	2	108	40131	0	334, 365	40410	6	294	40607	0	272
15620	3	77	30286	0	366	33279	9	108	40132	7	361	40411	3	294	40610	0	271
15621	0	77	30287	7	366	33280	5	109	40135	8	361	40412	0	294	40611	7	271
15622	7	77	30288	4	366	33281	2	109	40137	2	361	40413	7	294	40612	4	271
15623	4	77	30299	0	363	33285	0	72	40139	6	361	40414	4	300	40613	1	271
15921	1	304	30310	2	373	33286	7	72	40140	2	361	40415	1	295	40616	2	272
15925	9	304	30325	6	92	33288	1	103	40144	0	72, 102, 361	40424	3	298	40617	9	272
15926	6	304	30332	4	418	33290	4	148, 328	40148	8	361	40425	0	346	40618	6	272
17910	3	15	30333	1	425	33291	1	148, 328	40149	5	362	40435	9	293	40620	9	271
17922	6	15	30334	8	73, 87	33292	8	148, 328	40150	1	363	40436	6	293	40621	6	271
18121	2	531	30335	5	89	33293	5	148, 328	40152	5	361	40437	3	293	40622	3	271
18380	3	141, 527	30336	2	88	33294	2	148, 149, 328, 528	40153	2	362	40438	0	293	40623	0	271
18387	2	27, 362, 527	30337	9	88, 371	33295	9	148, 149, 528	40159	4	361	40439	7	293	40630	8	272
18388	9	27, 29, 31, 253, 362, 527	30338	6	88	33296	6	148, 328	40179	2	364	40440	3	295	40631	5	272
18389	6	16, 362	30339	3	87	33297	3	148, 328	40182	2	364	40441	0	295	40632	2	320
18394	0	121	30340	9	369	34248	4	92, 233	40185	3	273	40442	7	293	40633	9	320
18621	7	531	30341	6	369	35050	2	394	40186	0	118, 273	40445	8	299	40634	6	320
<b>2</b>			30345	4	368	35065	6	394	40187	7	118, 273	40446	5	299	40635	3	320
23642	4	119	30346	1	368	35343	5	394	40188	4	118, 273	40450	2	295	40636	0	320
<b>3</b>			30347	8	368	35350	3	305	40189	1	373	40453	3	298	40637	7	320
30000	2	76	30348	5	368	35711	2	333	40190	7	373	40454	0	298	40638	4	320
30001	9	76	30350	8	369	35720	4	332	40191	4	361	40455	7	296	40640	7	272
30002	6	76	30351	5	369	35730	3	332	40192	1	361	40457	1	296	40642	1	268
30020	0	76	30355	3	308, 368	35734	1	332	40193	8	361	40458	8	296	40643	8	268
30021	7	76	30356	0	136, 308, 368	35735	8	332	40194	5	361	40460	1	296	40644	5	268
30045	3	507	30357	7	373	35912	3	333	40195	2	361	40461	8	296, 297	40645	2	320
30046	0	508	30358	4	373	36003	7	416	40196	9	361	40462	5	296, 297	40646	9	320
30047	7	508	30360	7	369	36004	4	416	40198	3	364	40463	2	296	40647	6	320
30048	4	508	30361	4	369	36010	5	437									



40668	1	304, 319	50702	9	354	60541	1	317	74207	9	115	81391	5	400	82117	0	403
40669	8	319	50703	6	354	60542	8	316	74402	8	505	81395	3	400	82118	7	403
40670	4	132, 136, 282, 284	50705	0	354	60550	3	318	74404	2	505	81400	4	398	82119	4	403
40671	1	132, 136, 282, 284	50706	7	354	60551	0	318	74700	5	503	81401	1	398	82120	0	403
40672	8	132, 136, 282, 284	50707	4	354	60552	7	318	74701	2	503	81402	8	398	82122	4	403
40673	5	132, 136, 282, 284	50708	1	354	60554	1	318	74702	9	503	81404	2	398	82123	1	403
40674	2	132, 136, 282, 284	50710	4	353	61190	0	115	74703	6	503	81406	6	398	82128	6	403
40675	9	269, 283	50711	1	353	61280	8	115	74705	0	503	81408	0	398	82129	3	403
40676	6	269, 283	50712	8	353	61400	0	115	74706	7	503	81492	9	400	82130	9	403
40677	3	132, 136, 284	50713	5	353	65060	2	305, 349, 391, 436	74707	4	504	81495	0	400	82132	3	403
40678	0	132, 136, 284	50714	2	353	65061	9	349, 391	74708	1	504	81502	5	398	82134	7	403
40679	7	132, 136, 284	50720	3	354	65062	6	349, 391	74721	0	503	81504	9	398	82136	1	403, 404
40680	3	269, 464	50722	0	354	65070	1	435	74731	9	506	81506	3	398	82137	8	403
40681	0	269, 464	50727	7	354	65071	8	435	74750	0	463	81591	9	400	82138	5	403
40685	8	139, 273, 280	50723	4	354	65072	5	436	75001	2	305	81595	7	400	82140	8	403
40686	5	139, 273, 280	50800	2	357	66900	0	537	75002	9	305	81602	2	398	82142	2	403
40690	2	274, 370	50801	9	357	66901	7	537	75009	7	492	81604	6	398	82150	7	403
40691	9	274, 370	50802	6	357	66902	4	537	75600	7	492	81606	0	398	82151	4	403
40692	6	274, 370	50803	3	357	66904	8	513	75800	1	491	81608	4	398	82159	0	403
40693	3	274, 370	50805	7	357	66905	5	536	75801	8	487	81692	3	400	82200	9	405
40694	0	274, 370	50806	4	357	66906	2	536	75803	2	492	81695	4	400	82201	6	127, 405
40695	7	274, 370	50807	1	357	<b>7</b>			75804	9	492	81700	5	398	82202	3	127, 405
40700	8	266	50808	8	357	71001	6	492, 515	75805	6	449	81701	2	398	82203	0	127, 405
40701	5	266	50815	6	357	71002	3	492, 515	75806	3	491	81702	9	398	82204	7	127, 405
40702	2	266	50816	3	357	71003	0	492, 515	75807	0	491	81704	3	398	82205	4	127, 405
40703	9	266	50817	0	357	71004	7	492, 515	75808	7	489	81707	7	398	82210	8	379, 384
40704	6	266	50818	7	357	71005	4	492, 515	75809	4	489	81707	4	398	82215	3	379, 384
40705	3	266	50823	1	357	71006	1	492, 515	75810	0	488	81791	3	400	82239	9	70, 324
40706	0	267	50900	9	353	71006	1	492, 515	75820	9	449, 489	81795	1	400	82240	5	70, 324
40707	7	267	50901	6	353	71400	7	466	75821	6	449, 489	81796	8	404	82241	2	324
40708	4	267	50902	3	353	71421	2	521, 535	75822	3	488	81800	2	398	82242	9	324
40709	1	267	50905	4	353	71425	0	348	75823	0	488	81801	9	398	82243	6	70, 325
40710	7	267	50906	1	353	71426	7	348	75824	7	488	81802	6	398	82244	3	70, 325
40711	4	267	50907	8	353	71427	4	348	75825	4	487	81804	0	398	82250	4	69
40712	1	267	50908	5	353	71428	1	348	75830	8	487	81806	4	398	82251	1	69
40713	8	267	50908	5	353	71428	1	348	75831	5	487	81850	7	399	82252	8	69
40752	7	530	50910	8	353	71430	4	463	75832	2	487	81891	0	400	82253	5	69
<b>5</b>			50911	5	353	71431	1	445, 513	75840	7	486	81895	8	400	82255	9	68
50002	0	141	50912	2	353	71433	5	466	75841	4	486	81901	6	399	82256	6	68
50100	3	356	50913	9	353	71440	3	408	75842	1	486	81902	3	399	82257	3	68
50105	8	356	50915	3	354	71441	0	409	75843	8	486	81903	0	399	82265	8	68
50110	2	356	50916	0	354	71460	1	343	75844	5	486	81904	7	399	82266	5	68
50205	5	356	50917	7	354	71461	8	343	75900	8	483	81905	4	399	82267	2	68
50210	9	356	50918	4	354	71462	5	343	75902	2	483	81906	1	399	82300	6	405
50215	4	356	<b>6</b>			71470	0	347	75903	9	483	81907	8	399	82301	3	405
50300	7	356	60002	7	316	71471	7	347	75904	6	483	81908	5	399	82306	8	405
50305	2	356	60012	6	316	71472	4	347	75906	0	483	81909	2	399	82307	5	321
50310	6	356	60014	0	316	71474	8	347	75907	7	483	81910	8	399	82308	2	321
50315	1	356	60015	7	316	71480	9	347	75908	4	483	81911	5	399	82309	9	321
50400	4	356	60016	4	316	71482	3	347	75912	1	483	81996	2	401	82310	5	82, 326
50500	1	355	60018	8	316	71483	0	347	77315	8	463, 502	81997	9	401	82312	9	82, 139, 280, 326
50501	8	355	60019	5	316	71487	8	346	77338	7	506	81998	6	401	82314	3	82, 326
50510	0	355	60020	1	318	71489	2	346	77350	9	513	81999	3	401	82316	7	280, 322
50600	8	357	60022	5	318	71490	8	348	77352	3	513	82001	2	402, 406	82318	1	327
50601	5	357	60023	2	318	71491	5	348	79553	2	86, 141	82003	6	402	82319	8	327
50602	2	357	60024	9	318	71492	2	344	<b>8</b>			82004	3	402	82328	0	66, 69
50603	9	357	60037	9	314	71493	9	344	80023	6	401	82005	0	402	82338	9	327
50605	3	357	60038	6	314	71494	6	344	80024	3	401	82006	7	402	82345	7	322
50606	0	357	60040	9	314	71495	3	346	80025	0	401	82007	4	402	82346	4	322
50607	7	357	60041	6	316	71496	0	341	80026	7	401	82008	1	402	82347	1	322
50608	4	357	60042	3	316	71497	7	341	80027	4	401	82010	4	402, 403	82349	1	322
50610	7	357	60044	7	315	71498	4	346	80028	1	401	82012	8	402	82350	1	323
50611	4	357	60045	4	315	71499	1	346	80028	1	401	82013	5	402, 406	82351	8	323
50612	1	357	60046	1	315	71510	3	342	80029	8	401	82014	2	402	82352	5	323
50613	8	357	60270	0	115	71511	0	342	81000	6	398	82016	6	402	82354	9	323
50620	6	358	60310	3	115	71512	7	342	81095	2	398	82017	3	402	82355	6	15, 127, 405
50621	3	358	60312	2	115	71513	4	342	81100	3	398	82018	0	402	82356	3	127, 405
50622	0	358	60502	2	314	71514	1	342	81101	0	398	82019	7	402, 406	82357	0	15, 127, 405
50623	7	358	60503	9	314	71515	8	342	81102	7	398	82020	3	402	82359	4	322
50624	4	358	60505	3	314	71516	5	342	81104	1	398	82022	7	402	82360	0	325
50625	1	358	60506	0	317	71517	2	342	81106	5	398	82023	4	402	82361	7	325
50626	8	358	60507	7	317	71518	9	342	81108	9	398	82024	5	402	82362	4	325
50627	5	358	60508	4	317	71520	2	341	81109	6	398	82028	9	402	82370	9	322
50628	2	358	60509	1	316	71521	9	340	81116	4	398	82029	6	402, 406	82371	6	322
50629	9	358	60510	7	317	71522	6	340	81117	1	401	82030	2	402	82376	5	327
50630	5	358	60511	4	317	71523	3	340	81118	8	401	82032	6	402	82394	5	327
50631	2	358	60512	1	316	71527	1	340	81119	1	400	82034	0	402	82395	2	327
50632	9	358	60520	6	316	71528	8	340	81191	1	400	82036	4	402	82419	5	412, 511
50633	6	358	60521	3	316	71528	8	340	81195	9	400	82036	4	402	82420	1	412
50634	3	358	60522	0	316	71529	5	340	81198	0	404	82037	1	402, 406	82440	9	412, 521
50635	0	358	60523	7													

83411	8	243	83654	9	230	83867	3	75	84080	5	244	84260	1	227	84490	2	246
83412	5	243	83655	6	230	83868	0	75	84082	9	244	84261	8	227	84491	9	246
83414	9	240, 243	83696	9	34, 248	83869	7	253	84083	6	244	84262	5	198	84492	6	246
83415	6	240	83697	6	34, 248	83875	8	245	84085	0	244	84263	2	198	84493	3	246
83417	0	239	83698	3	34, 248	83876	5	245	84086	7	244	84264	9	198	84494	0	246
83418	7	239	83699	0	34, 248	83877	2	245	84088	1	244	84265	6	198	84509	1	189
83419	4	240	83700	3	19, 34, 248	83878	9	234	84100	0	217	84266	3	196	84510	7	189
83424	8	258	83701	0	19, 34, 248	83879	6	234	84101	7	217	84267	0	196	84511	4	189
83426	2	258	83702	7	19, 34, 248	83880	2	248	84103	1	217	84268	7	196	84512	1	189
83433	0	238	83703	4	19, 34, 248	83881	9	248	84104	8	217	84269	4	196	84514	5	189
83434	7	238	83704	1	34, 248	83882	6	238	84105	5	217	84295	3	250	84515	2	189
83435	4	244	83705	8	34, 248	83884	0	239	84106	2	217	84300	4	406	84517	6	189
83437	8	244	83712	6	222	83886	4	239	84107	9	218	84301	1	406	84519	0	191
83438	5	244	83714	0	223	83887	1	258	84108	6	218	84302	8	406	84520	6	191
83440	8	244	83716	4	223	83888	8	258	84109	3	218	84303	5	406	84521	3	191
83441	5	244	83718	8	224	83889	5	258	84110	9	219	84304	2	406	84522	0	191
83443	9	244	83720	1	224	83890	1	146, 252, 329	84111	6	219	84305	9	406	84523	7	190
83446	0	245	83721	8	223	83891	8	146, 252, 329	84112	3	219	84306	6	406	84524	4	190
83450	7	240	83722	5	224	83892	5	146, 252	84113	0	219	84307	3	406	84525	1	190
83451	4	240	83723	2	223	83893	2	146, 252	84114	7	219	84308	0	406	84526	8	190
83452	1	240	83724	9	224	83897	0	256, 395	84115	4	219	84309	7	406	84528	2	190
83453	8	240	83725	6	223	83900	7	236	84116	1	219	84310	3	406	84529	9	190
83454	5	240	83726	3	224	83901	4	236	84117	8	219	84311	0	406	84530	5	190
83455	2	240	83727	0	223	83902	1	236	84118	5	219	84327	1	192	84531	2	93
83456	9	240	83728	7	224	83903	8	236	84119	2	219	84329	5	192	84532	9	93
83457	6	240	83730	0	224	83904	5	236	84124	6	228	84331	8	192	84535	0	337
83466	8	240, 243	83732	4	224	83905	2	236	84125	3	228	84334	9	192	84536	7	337
83467	5	240	83734	8	224, 225	83906	9	236	84126	0	228	84335	6	192	84555	8	209
83468	2	240	83735	5	223	83907	6	236	84128	4	228, 257	84336	3	192	84556	5	209
83469	9	240	83736	2	225	83908	3	236	84130	7	229	84337	0	192	84558	9	210
83479	8	238	83738	6	225	83909	0	236	84131	4	229	84348	6	223	84559	6	210
83480	4	238	83739	3	223	83910	6	237	84132	1	229	84349	3	223	84561	9	210
83481	1	71, 238	83740	9	225	83911	3	237	84133	8	229	84350	9	223	84562	6	210
83482	8	238	83742	3	225	83912	0	234, 237	84134	5	229	84351	6	223	84564	0	209
83483	5	239	83744	7	225	83913	7	234, 237	84135	2	229	84352	3	223	84565	7	209
83484	2	239	83748	5	406	83914	4	237	84136	9	229	84353	0	223	84567	1	200
83486	6	258	83749	2	406	83915	1	237	84140	6	257	84355	4	222	84568	8	200
83487	3	258	83750	8	406	83916	8	86, 237	84141	3	257	84363	3	199	84569	5	201
83488	0	473	83751	5	263	83917	5	86, 237	84142	0	257	84366	0	199	84570	1	201
83489	7	473	83752	2	406	83918	2	237	84158	1	228, 257	84367	7	187, 199	84571	8	201
83490	3	238	83753	9	406	83919	9	237	84161	1	216	84377	6	199	84572	5	201
83491	0	71, 238	83754	6	406	83920	5	34, 237, 248, 533	84165	9	216	84378	3	199	84573	2	201
83492	7	238	83755	3	406	83921	2	237, 533	84168	0	216	84379	0	199	84574	9	201
83497	2	242	83756	0	406	83922	9	237, 533	84170	3	216	84380	6	199	84575	6	200
83498	9	242	83757	7	406	83923	6	237	84171	0	216	84381	3	199	84576	3	200
83499	6	242	83758	4	406	83924	3	237	84172	7	216	84387	5	232	84577	0	201
83500	9	240	83759	1	406	83925	0	237	84174	1	219	84400	1	194	84578	7	201
83513	9	256	83760	7	407	83926	7	237	84177	2	197	84401	8	194	84579	4	201
83514	6	240	83761	4	407	83927	8	222	84178	9	197	84402	5	194	84580	0	201
83538	2	463	83762	1	407	83929	8	222	84179	6	197	84403	2	194	84581	7	201
83560	3	239	83763	8	407	83932	8	224	84180	2	215	84404	9	194	84582	4	201
83561	0	239	83764	5	407	83933	5	224	84181	9	215	84408	7	241	84583	1	209
83562	7	239	83765	2	407	83934	2	224	84182	6	215	84409	4	241	84584	8	209
83563	4	239	83766	9	407	83935	9	224	84183	3	215	84414	8	241, 243	84586	2	209
83568	9	240, 243	83768	3	407	83940	3	225	84184	0	215	84415	5	241, 243	84587	9	209
83569	6	240, 243	83769	0	407	83941	0	225	84185	7	25, 215	84416	2	241	84589	3	209
83570	2	240	83770	6	407	83946	5	225	84186	4	25, 215	84417	9	241	84590	9	209
83571	9	240	83772	0	407	83947	2	225	84187	1	71, 215	84418	6	241	84592	3	210
83572	6	240	83773	7	407	83948	9	225	84188	8	25, 215	84420	9	241, 243	84593	0	210
83573	3	240	83777	5	248	83949	6	225	84189	5	25, 215	84421	6	241	84595	4	211
83574	0	240	83780	5	248	83955	7	212	84195	6	25, 215	84422	3	241	84596	1	211
83575	7	240	83781	2	248, 274, 370	83956	4	212	84196	3	25, 215	84423	0	241	84598	5	211
83587	0	233	83782	9	248	83957	1	212	84197	0	71, 215	84424	7	240	84599	2	211
83588	7	238	83783	6	248	83958	8	212	84198	7	25, 215	84425	4	240	84601	2	206
83589	4	238	83784	3	248	83960	1	235	84199	4	25, 215	84426	1	240	84602	9	206
83592	4	238	83785	0	232	83961	8	235	84200	7	233	84427	8	240	84603	6	206
83597	9	238	83786	7	232	83962	5	235	84202	1	233	84434	6	197	84604	3	206
83600	6	213, 241, 533	83787	4	232	83965	6	235	84205	2	198	84435	3	197	84605	0	207
83601	3	210, 123, 241, 533	83788	1	232	83966	3	235	84206	9	198	84440	7	238	84606	7	207
83602	0	241, 533	83789	8	232	83967	0	235	84207	6	198	84441	4	238	84607	4	207
83603	7	242	83790	4	232	83971	7	212	84208	3	198	84444	5	261	84608	1	207
83604	4	242	83798	0	248	83980	9	212	84209	0	198	84445	2	261	84609	8	207
83605	1	249, 533	83799	7	232	83981	6	212	84215	1	250	84446	9	261	84610	4	207
83606	8	249, 533	83800	0	231	83992	2	213	84216	8	250	84448	3	261	84611	1	207
83607	5	249, 533	83801	7	256, 395	83994	6	213	84217	5	229, 262	84449	0	261	84612	8	207
83610	5	473	83803	1	256, 395	83999	1	338	84220	5	250	84450	6	262	84613	5	207
83611	2	473	83808	6	231	84017	1	262	84221	2	250	84452	0	262	84614	2	207
83612	9	473	83810	9	231	84018	8	262	84222	9	250	84454	4	262	84615	9	207
83613	6	473	83812	3	231	84020	1	255	84229	8	227	84456	8	262	84616	6	207
83614	3	473	83814	7	231	84021	8	255	84230	4	227	84458	2	262	84620	3	144, 256
83615	0	94	83826	0	231	84022	5	226	84231	1	227	84460	5	262</			

84673	9	178	84831	3	194	85003	3	245	88080	1	502, 510	93034	6	442	93310	1	430
84674	6	179	84835	1	187	85005	7	245	88081	8	502, 510	93101	5	454	93311	8	430
84675	3	179	84836	8	187	85020	0	184	88090	0	510	93102	2	449	93312	5	443
84676	0	179	84837	5	187	85021	7	184	88099	3	502	93105	3	60, 425	93313	2	443
84677	7	179	84840	5	259	85022	4	184	88200	3	396	93110	7	455	93314	9	451
84678	4	179	84841	2	259	85023	1	184	88201	0	396	93111	4	455	93315	6	451
84680	7	180	84842	9	259	85024	8	185	88202	7	396	93112	1	441	93318	7	445
84681	4	180	84843	6	259	85025	5	184	88204	1	396	93114	5	455	93321	7	152, 411
84682	1	180	84844	3	259	85026	2	185	88205	8	396	93115	2	455	93322	4	430
84683	8	180	84845	0	259	85027	9	184	88206	5	396	93116	9	441	93323	1	430
84684	5	181	84860	3	74	85028	6	184	88207	2	396	93120	6	441	93324	8	440
84685	2	181	84861	0	74	85029	3	185	88208	9	396	93121	3	441	93325	5	438
84686	9	181	84862	7	74	85030	9	185	88209	6	396	93122	0	457	93326	2	437
84687	6	181	84863	4	74	85031	6	185	88210	2	396	93124	4	457	93327	9	434
84688	3	181	84875	7	216	85032	3	185	88211	9	396	93125	1	457	93328	6	434
84689	0	181	84876	4	216	85033	0	146, 185, 329	88212	6	396	93129	9	442	93329	3	434
84690	6	181	84880	1	188	85034	7	146, 185, 329	88220	1	270	93134	3	442	93330	9	416, 429
84720	0	197	84881	8	188	85035	4	146, 185, 329	88221	8	270	93138	1	438	93331	6	431
84721	7	197	84882	5	188	85040	8	253	88222	5	270	93139	8	438	93332	3	431
84722	4	197	84883	2	188	85041	5	253	88223	2	270	93140	4	438	93333	0	431
84723	1	197	84884	9	188	85042	2	253	88224	9	270	93141	1	454	93334	7	433
84724	8	197	84885	6	188	85043	9	253	88225	6	270	93144	2	454	93335	4	433
84725	5	177	84886	3	188	85046	0	146, 213, 329	88226	3	270	93145	9	454	93336	1	434
84726	2	177	84890	0	196	85047	7	146, 213, 329	88227	0	270	93146	6	454	93337	8	434
84727	9	177	84891	7	196	85048	4	146, 213, 329	88228	7	270	93147	3	454	93338	5	434
84728	6	218	84892	4	196	85051	4	147, 149, 252, 330, 528	88229	4	270	93148	0	454	93342	2	431
84729	3	218	84900	6	220	85052	1	147, 149, 252, 330, 528	88246	1	400	93151	0	518	93343	9	431
84730	9	218	84901	3	220	85060	6	165	88256	0	521	93152	7	442	93344	6	431
84731	6	218	84902	0	220	85061	3	165	88271	3	518	93153	4	442	93345	3	430
84732	3	218	84903	7	220	85062	0	165	88285	0	404	93154	1	516	93346	0	429
84733	0	218	84904	4	220	85063	7	164	88287	4	514	93155	8	516	93347	7	443
84740	8	186	84905	1	221	85064	4	164	88288	1	514	93156	5	516	93348	4	443
84741	5	186	84906	8	221	85065	1	164	88598	1	493	93157	2	516	93349	1	443
84742	2	186	84907	5	221	85066	8	164	88608	7	479	93160	2	455	93350	7	438
84743	9	186	84908	2	221	85067	5	164	88609	4	493	93161	9	453	93351	4	439
84744	6	186	84909	9	221	85068	2	164	88617	9	504	93163	3	516	93352	1	439
84745	3	186	84910	5	221	85069	9	165	88618	6	504	93164	0	440	93353	8	439
84746	0	186	84911	2	221	85070	5	165	88627	8	493	93165	7	440	93354	5	439
84747	7	186	84912	9	221	85071	2	165	88628	5	493	93166	4	451	93355	2	440
84748	4	186	84913	6	221	85072	9	165	88636	0	493	93167	1	451	93356	9	441
84749	1	186	84914	3	221	85080	4	160	88637	7	479	93168	8	451	93357	6	441
84750	7	260	84915	0	221	85081	1	160	88639	1	504	93169	5	451	93358	3	444
84751	4	260	84920	4	204	85082	8	161	88640	7	478	93170	1	453	93360	6	444
84752	1	260	84921	1	204	85083	5	161	88642	1	478	93171	8	452	93361	3	444
84753	8	260	84922	8	204	85084	2	161	88643	8	491	93173	2	451	93362	0	444
84754	5	260	84923	5	204	85088	0	254	88644	5	491	93174	9	452	93364	4	432
84760	6	260	84924	2	204	85091	0	254	88645	2	491	93175	6	448	93365	1	432
84761	3	260	84925	9	204	85100	9	162	88688	9	506	93179	4	437	93366	8	437
84762	0	260	84926	6	205	85101	6	162	88717	6	505	93180	0	444	93367	5	429
84763	7	260	84927	3	205	85103	0	162	88810	4	496	93181	7	444	93368	2	442
84764	4	260	84928	0	205	85104	7	162	88811	1	496	93182	4	444	93369	9	442
84775	0	261	84929	7	205	85105	4	162	88823	4	496	93188	6	444	93370	5	431
84776	7	261	84930	3	208	85107	8	162	88826	5	496	93189	3	446, 513	93371	2	432
84777	4	261	84931	0	208	85108	5	162	88827	2	496	93190	9	449	93372	9	432
84778	1	261	84932	7	208	85109	2	162	88829	6	497	93191	6	448	93373	6	432
84779	8	261	84933	4	208	85111	5	162	88834	0	497	93192	3	448	93374	3	432
84780	4	261	84934	1	208	85112	2	149, 162, 528	88836	4	497	93200	5	447	93375	0	433
84781	1	261	84935	8	208	85113	9	162	88839	5	498	93201	2	438	93380	4	450
84782	8	261	84936	5	208	85115	3	162	88840	1	498	93211	1	437	93381	1	450
84783	5	261	84937	2	208	85116	0	162	88843	2	445, 498	93212	8	437	93382	8	450
84785	9	232	84938	9	208	85117	7	162	88846	3	445, 497	93214	2	446, 513	93383	5	450
84786	6	232	84939	6	209	85118	4	162	88850	0	497	93220	3	447	93384	2	450
84787	3	232	84940	2	209	85119	1	162	88853	1	498	93225	8	515	93385	9	450
84800	9	183	84941	9	205	85120	7	163	88855	5	514	93226	5	515	93386	6	450
84801	6	183	84942	6	205	85121	4	163	88900	2	514	93230	2	61, 447	93390	3	450
84802	3	183	84943	3	205	85122	8	163	88901	9	514	93250	0	517	93391	0	450
84803	0	183	84944	0	205	85123	5	163	88902	6	514	93251	7	517	93392	7	450
84804	7	183	84945	7	205	85124	2	163	88903	3	515	93252	4	517	93393	4	450
84805	4	183	84946	4	205	85125	2	163	88911	8	514	93253	1	517	93394	1	450
84806	1	183	84947	1	210	85126	6	163	88912	5	514	93254	8	517	93395	8	450
84807	8	183	84948	8	210	85127	3	163	88920	0	499	93255	5	517	93398	9	418, 433
84808	5	183	84950	1	247	85128	0	163	88921	7	499	93256	2	517	93399	6	418, 433
84809	2	182	84951	8	247	85131	3	163	88922	4	499	93257	9	517	93400	9	418, 433
84810	8	183	84952	5	246	85132	0	163	88923	1	499	93258	6	517	98002	0	99
84811	5	183	84953	2	246	85133	7	163	88928	6	499	93259	3	516	98003	7	99
84812	2	183	84954	9	246	85135	1	163	88929	3	501	93260	9	516	98040	2	99
84813	9	183	84955	6	247	85140	5	251	88930	9	501	93261	6	516	98041	9	99
84814	6	183	84956	3	247	85141	2	251	88932	3	499	93270	8	517	98120	1	96
84815	3	182	84957	0	247	85145	0	195	88933	0	499	93271	5	517	98129	4	97
84816	0	182	84958	7	247	85146	7	195	88935	4	500	93272	2	517	98130	0	97
84817	7	182	84959	4	247	85150	4	229	88937	8	500	93273	9	517	98131	7	97
84818	4	182	84962	4	532	85151	1	229	88938	5	500	93274	6				

## DE Impressum

Herausgeber: Assheuer + Pott GmbH & Co. KG, Talweg 11, 59846 Sundern, Tel. +49 2933 97350, info@aps-germany.de, www.aps-germany.de  
Gestaltung: Assheuer + Pott GmbH & Co. KG · Druck: Druck- und Verlagshaus Fromm + Rasch GmbH & Co. KG, Breiter Gang 10-16, 49074 Osnabrück  
Wir behalten uns das Recht vor, die angegebenen Spezifikationen jederzeit zu ändern. Irrtum, Druckfehler und technische Änderungen vorbehalten. Artikelbeschreibungen sowie Abbildungen und Fotodarstellungen sind ohne Gewähr. Alle Angebote ohne Dekoration. Alle Preise verstehen sich unverbindlich (UVP) in Euro zuzüglich der gesetzlichen Mehrwertsteuer.  
© 2022 - Die Vervielfältigung dieses Kataloges - auch wenn partial - muss ausschließlich von der Assheuer + Pott GmbH & Co. KG genehmigt werden.  
Bildnachweis: Niklas Thiemann Fotodesign · Stoll Fotografie · iStock

## GB Imprint

Editor: Assheuer + Pott GmbH & Co. KG, Talweg 11, 59846 Sundern, Germany, Tel. +49 2933 97350, info@aps-germany.de, www.aps-germany.de  
Design: Assheuer + Pott GmbH & Co. KG - Print: Druck- und Verlagshaus Fromm + Rasch GmbH & Co. KG, Breiter Gang 10-16, 49074 Osnabrück, Germany  
We reserve the right to alter at any time the specifications stated without notice. Errors, printing error and technical changes reserved. Item description as well as images and illustrations are without guaranty. All offers are without decoration. All prices are without commitment (RRP) in Euro and exclude the legal VAT prescribed by law.  
© 2022 - This catalogue may not be reproduced in whole or in part unless specific prior written authorization of Assheuer + Pott GmbH & Co. KG.  
Picture credits: Niklas Thiemann Fotodesign · Stoll Fotografie · iStock

## ES Impressum

Editor: Assheuer + Pott GmbH & Co. KG, Talweg 11, 59846 Sundern, Alemania, Tel. +49 2933 97350, info@aps-germany.de, www.aps-germany.de  
Diseño gráfico: Assheuer + Pott GmbH & Co. KG - Impresión: Druck- und Verlagshaus Fromm + Rasch GmbH & Co. KG, Breiter Gang 10-16, 49074 Osnabrück, Alemania  
Nos reservamos el derecho de efectuar modificaciones en cualquier momento, sin aviso previo. Salvo errores de imprenta o impresión o cambios técnicos. La descripción de los artículos, sus imágenes e ilustraciones son sin garantía. Los artículos se ofrecen sin decoración. Todos los precios indicados son precios sugeridos (PVR) en euros y a dichos precios se deberá añadir el impuesto sobre el valor añadido legal vigente.  
© 2022 - Todas las reproducciones, aunque parciales, de este catálogo tienen que ser autorizadas por escrito por Assheuer + Pott GmbH & Co. KG.  
Derechos de la imagen: Niklas Thiemann Fotodesign · Stoll Fotografie · iStock

## FR Impressum

Éditeur: Assheuer + Pott GmbH & Co. KG, Talweg 11, 59846 Sundern, Allemagne, Tel. +49 2933 97350, info@aps-germany.de, www.aps-germany.de  
Design: Assheuer + Pott GmbH & Co. KG - Impression: Druck- und Verlagshaus Fromm + Rasch GmbH & Co. KG, Breiter Gang 10-16, 49074 Osnabrück, Allemagne  
Nous nous réservons le droit de modifier à tout moment les spécifications. Toutes erreurs, fautes d'impression et modifications techniques sont réservées. Les descriptions d'articles, les illustrations et les photos sont sans garantie. Toutes les articles s'entendent hors décoration. Tous les prix sont donnés sans engagement (PVC) et s'entendent en Euro et T.V.A. légale en vigueur non incluse.  
© 2022 - Toute reproduction même partielle de ce catalogue est interdite sauf autorisation expresse de Assheuer + Pott GmbH & Co. KG.  
Crédit photo: Niklas Thiemann Fotodesign · Stoll Fotografie · iStock





buffet | tabletop | bar

**Assheuer + Pott GmbH & Co. KG**

Talweg 11 | 59846 Sundern

Germany

Phone: +49 (0) 29 33 / 97 35 - 0

E-Mail: [info@aps-germany.de](mailto:info@aps-germany.de)

[aps-germany.de](http://aps-germany.de)

KATALOG NR 48

CATALOG NO 48

CATÁLOGO N° 48

CATALOGUE N° 48



**Keep in touch!**  
[aps\\_germany](https://www.instagram.com/aps_germany)

